

Wire-to-Wire: Poke Home, Junction Box

Series 9286



Wire-to-Wire connectors have been used in the industrial market for years with traditional 2-Piece (plug and socket) connector systems which require crimp and poke wire terminations to connect electrical or electronic components. In the general wiring market (2-3 wires) there are a number of connector styles available, however, they are limited in sizes, expanded wire gauges and the ability to reuse them when repair or replacement is needed. Based on the existing success of "Poke Home" wire-to-board connectors, AVX has developed a new family of wire-to-wire connectors to meet the cost, flexibility and ease-of-use targets in industrial wiring applications.

The 9286 series of Junction Box connectors provide a high spring force Beryllium Copper contact system that uses simple push button activation to insert and remove individual stripped wires in the connection process. There is a forward and aft shrouded (to prevent accidental activation) push button for each wire connection that can be operated individually or simultaneously with a simple plastic tool or ball point pen tip. This connector family has been designed to bring a single wire in and then have multiple output (bus structure) wires of the same power or signal. Four, Six or Eight wires can be electrically connected together in a single connector body which will support any combination of wire gauges from 18AWG up to 26 AWG. Wires can be removed or replaced up to 5 times so there is no need to replace the connector in a new installation.

APPLICATIONS

- Industrial/Machine Control; motors, solenoids, PLC's, pumps, valves, sensors, fans...
- Commercial/Building; fixtures, fire, security, surveillance, blinds, sensors, controls...
- Commercial/Industrial LED; retail, office, manufacturing, signage, displays...
- Application notes; refer to 201-01-135

FEATURES AND BENEFITS

- High spring force top contact provides a lance type retention to capture and retain the wire
- Shrouded dual push button activation for easy wire insertion/removal
- Accepts 18-26AWG Solid and Stranded wires; any combination
- Expanded size offering to maximize application potential; 4, 6 or 8 positions
- Optional mounting tape to secure in panel mounting applications
- Molded in position numbers and schematic for easy identification

ELECTRICAL

- Current Rating: 10 Amps total
- Voltage Rating: 250v AC

ENVIRONMENTAL

- Operating Temperature: -40°C to +125°C

MECHANICAL

- Insulator Material: Glass-Filled Nylon 46; UL94V0
- Contact Material: Beryllium Copper / Phosphor Bronze
- Plating: Tin over Nickel
- Replacibility: 5 Cycles

HOW TO ORDER

00	9286	00X	121	X	06																										
Prefix	Series	Number of Ways	Wire Size	Insulator Color	Plating Option																										
		<table border="1"> <thead> <tr> <th>Code</th> <th>No of Ways</th> <th>Details</th> </tr> </thead> <tbody> <tr> <td>004</td> <td>4</td> <td>Page 10</td> </tr> <tr> <td>006</td> <td>6</td> <td>Page 11</td> </tr> <tr> <td>008</td> <td>8</td> <td>Page 12</td> </tr> </tbody> </table>	Code	No of Ways	Details	004	4	Page 10	006	6	Page 11	008	8	Page 12	<table border="1"> <thead> <tr> <th>Code</th> <th>Wire Gauge</th> <th>Max Conductor</th> <th>Max Insulation</th> </tr> </thead> <tbody> <tr> <td>121</td> <td>18 to 26 AWG</td> <td>1.05mm Diameter</td> <td>2.10mm Diameter</td> </tr> </tbody> </table>	Code	Wire Gauge	Max Conductor	Max Insulation	121	18 to 26 AWG	1.05mm Diameter	2.10mm Diameter	<table border="1"> <thead> <tr> <th>Code</th> <th>Color</th> <th>Application</th> </tr> </thead> <tbody> <tr> <td>5</td> <td>Red</td> <td>Standard</td> </tr> </tbody> </table>	Code	Color	Application	5	Red	Standard	06 = Tin all over
Code	No of Ways	Details																													
004	4	Page 10																													
006	6	Page 11																													
008	8	Page 12																													
Code	Wire Gauge	Max Conductor	Max Insulation																												
121	18 to 26 AWG	1.05mm Diameter	2.10mm Diameter																												
Code	Color	Application																													
5	Red	Standard																													

Wire-to-Wire: Poke Home, Junction Box **AVX**

Series 9286

18-26 AWG 4 WAY POKE HOME – JUNCTION BOX

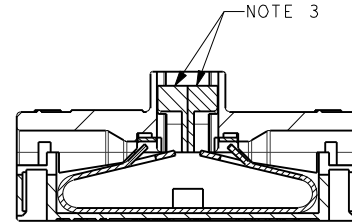
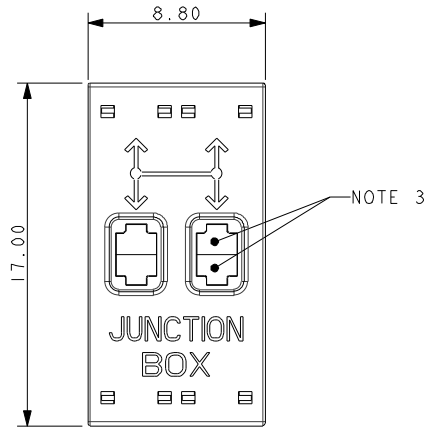

SECTION ON A-A

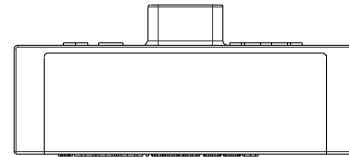
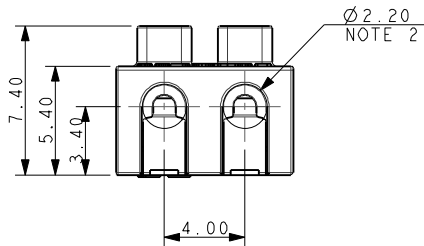

PACKING DETAILS

REEL Ø	330MM
MAX REEL WIDTH	30.4MM
LEADER	500MM
TRAILER	500MM
QTY PER REEL	400

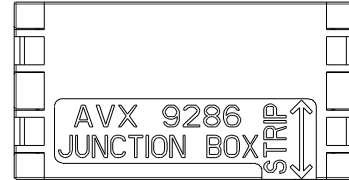

NOTE 8

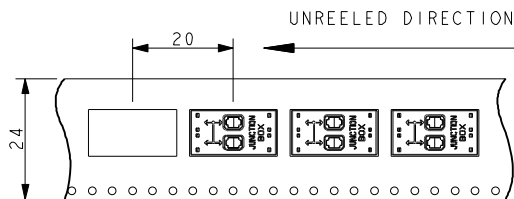

UNREELED
DIRECTION

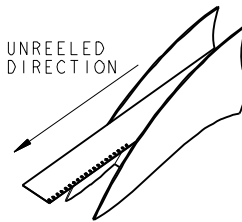

NOTES:

1. 4 WAY WIRE TO WIRE "POKE HOME" CONNECTOR, BUTTON OPERATED. ALL TERMINALS INTERCONNECTED.
2. WIRE SIZES 18-26 AWG, MAXIMUM INSULATION DIAMETER 2.10MM.
3. SPLIT BUTTON ALLOWS THE WIRES TO BE INSERTED/WITHDRAWN INDEPENDENTLY.
4. INSULATION MATERIAL: NYLON 46, GLASS FILLED, UL94 V-0. COLOR SEE PAGE 9.
5. CONTACT MATERIAL: TIN PLATED COPPER ALLOY.
6. FOR FULL SPECIFICATION REFER TO ELCO SPECIFICATION 201-01-132. FOR APPLICATION NOTES REFER TO ELCO SPECIFICATION 201-01-135.
7. GENERAL TOLERANCE ± 0.20 MM.
8. WIRE STRIP LENGTH GUIDE, SEE PAGE 13.

Wire-to-Wire: Poke Home, Junction Box

Series 9286

18-26 AWG 6 WAY POKE HOME – JUNCTION BOX

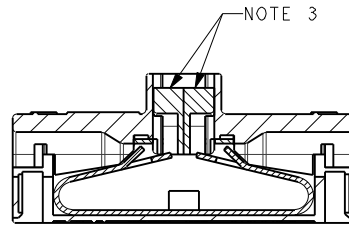
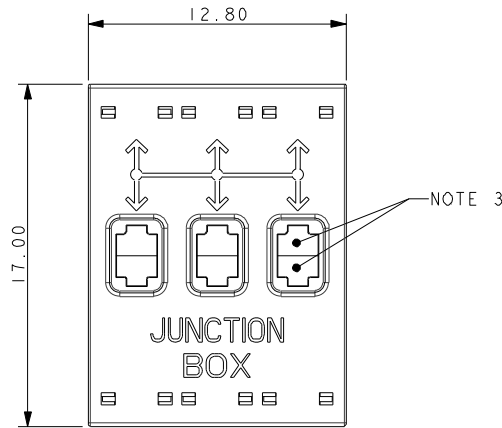

SECTION ON A-A

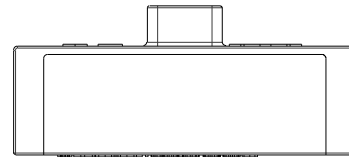
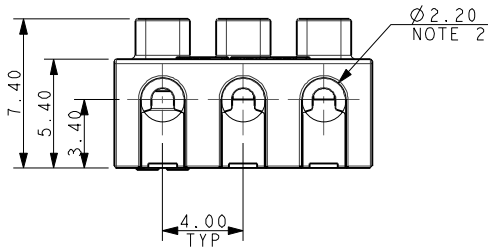

PACKING DETAILS

REEL Ø	330MM
MAX REEL WIDTH	30.4MM
LEADER	500MM
TRAILER	500MM
QTY PER REEL	400

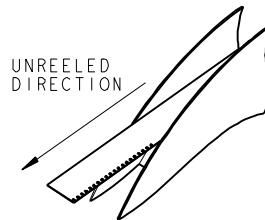
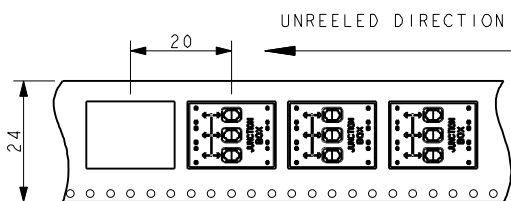
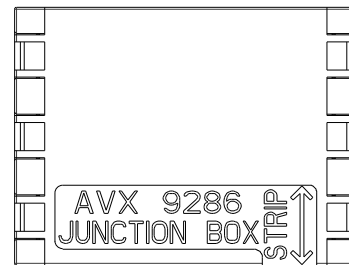

NOTE 8

NOTES:

- 6 WAY WIRE TO WIRE "POKE HOME" CONNECTOR, BUTTON OPERATED. ALL TERMINALS INTERCONNECTED.
- WIRE SIZES 18-26 AWG, MAXIMUM INSULATION DIAMETER 2.10MM.
- SPLIT BUTTON ALLOWS THE WIRES TO BE INSERTED/WITHDRAWN INDEPENDENTLY.
- INSULATION MATERIAL: NYLON 46, GLASS FILLED, UL94 V-0. COLOR SEE PAGE 9.
- CONTACT MATERIAL: TIN PLATED COPPER ALLOY.
- FOR FULL SPECIFICATION REFER TO ELCO SPECIFICATION 201-01-132. FOR APPLICATION NOTES REFER TO ELCO SPECIFICATION 201-01-135.
- GENERAL TOLERANCE ± 0.20 MM.
- WIRE STRIP LENGTH GUIDE, SEE PAGE 13.

Wire-to-Wire: Poke Home, Junction Box

Series 9286

18-26 AWG 8 WAY POKE HOME – JUNCTION BOX

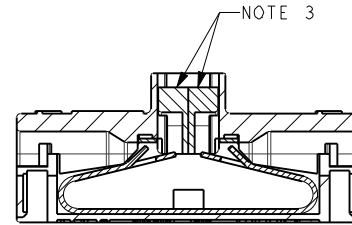
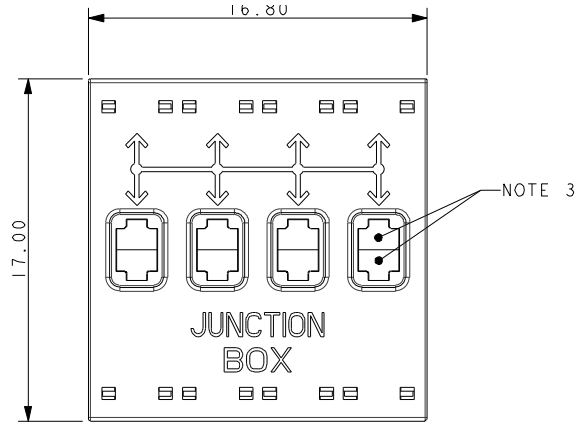

SECTION ON A-A

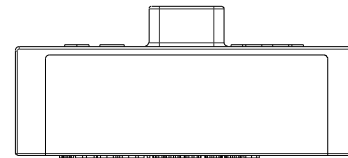
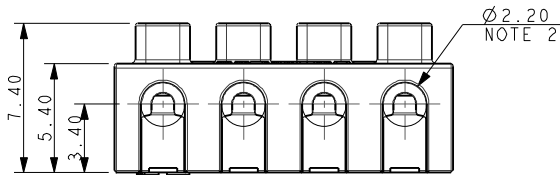

PACKING DETAILS

REEL Ø	330MM
MAX REEL WIDTH	38.4MM
LEADER	500MM
TRAILER	500MM
QTY PER REEL	400

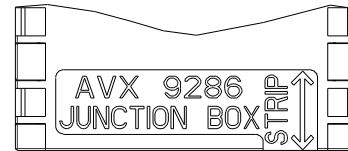

NOTE 8

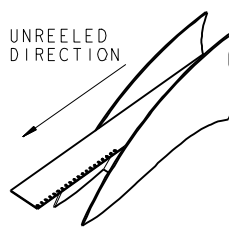
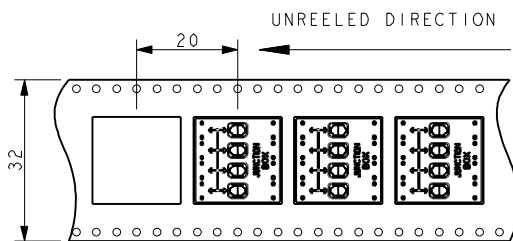

NOTES:

- 8 WAY WIRE TO WIRE "POKE HOME" CONNECTOR, BUTTON OPERATED. ALL TERMINALS INTERCONNECTED.
- WIRE SIZES 18-26 AWG, MAXIMUM INSULATION DIAMETER 2.10MM.
- SPLIT BUTTON ALLOWS THE WIRES TO BE INSERTED/WITHDRAWN INDEPENDENTLY.
- INSULATION MATERIAL: NYLON 46, GLASS FILLED, UL94 V-0. COLOR SEE PAGE 9.
- CONTACT MATERIAL: TIN PLATED COPPER ALLOY.
- FOR FULL SPECIFICATION REFER TO ELCO SPECIFICATION 201-01-132. FOR APPLICATION NOTES REFER TO ELCO SPECIFICATION 201-01-135.
- GENERAL TOLERANCE ± 0.20 MM.
- WIRE STRIP LENGTH GUIDE, SEE PAGE 13.

POKE HOME BUTTON ACTIVATION TOOL

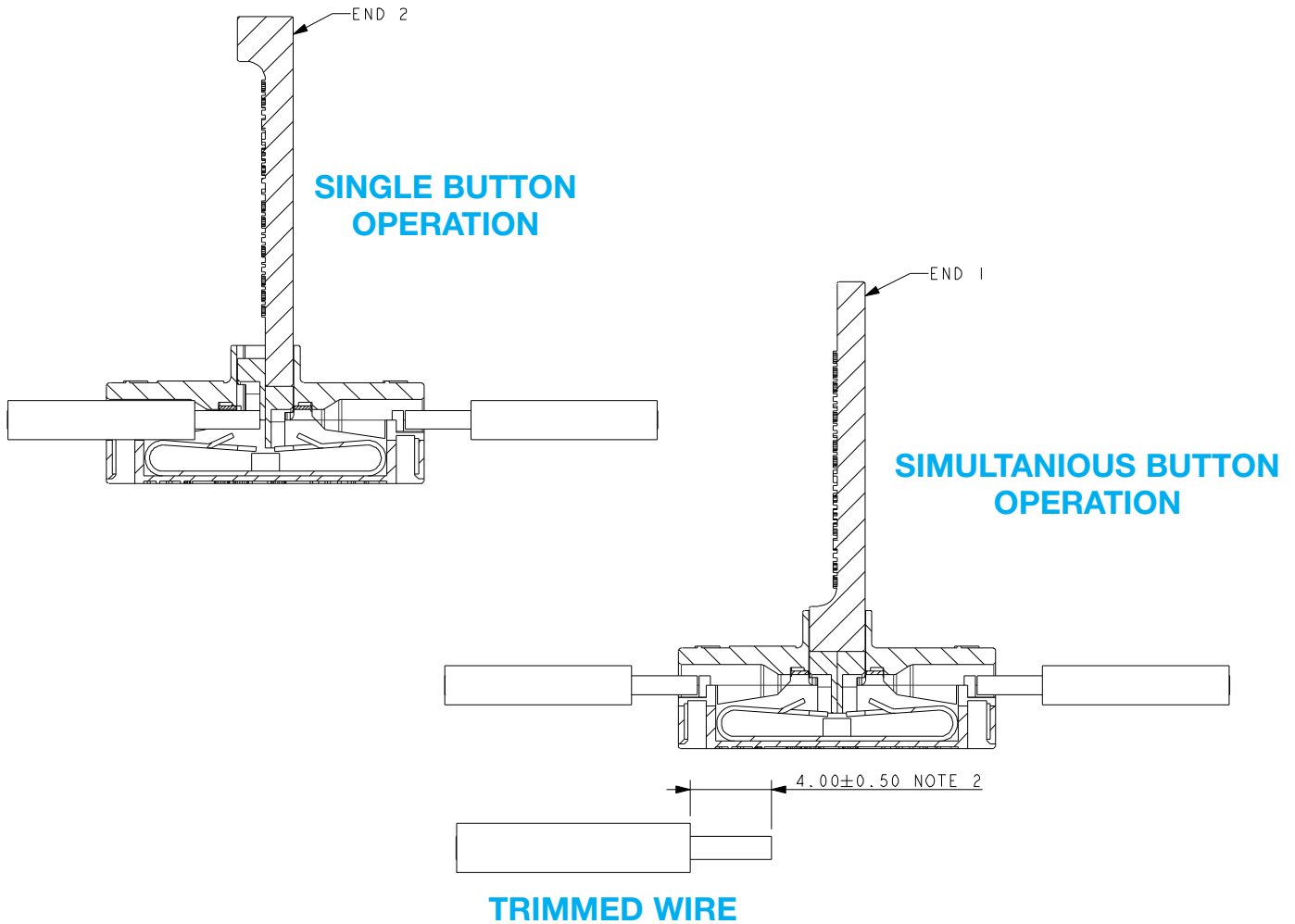

9286 BUTTON ACTIVATION TOOL

06-9286-7001-01-000

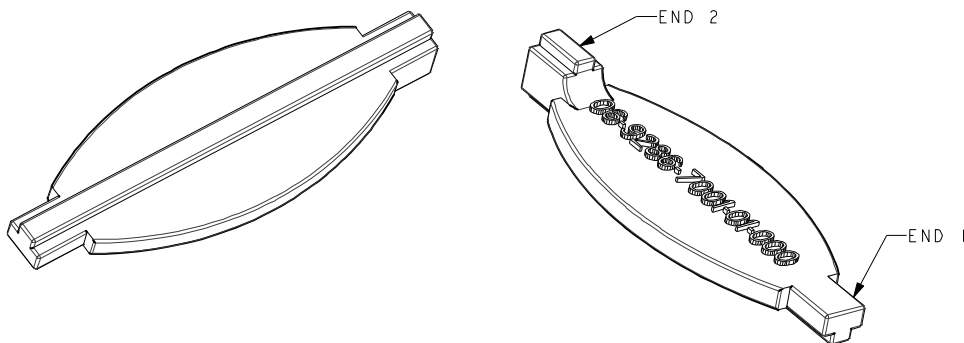

NOTES:

1. TOOL IS DOUBLE ENDED. END 1 ACTIVATES SINGLE BUTTON.
END 2 FOR SIMULTANEOUS BUTTON ACTIVATION.
2. WIRE WHEN TRIMMED TO BE STRAIGHT WITH NO BURRS.
3. FOR FULL ASSEMBLY DETAILS REFER TO APPLICATION NOTES 201-01-135.