

■Features

- 5mm Standard Directivity
- Water Clear Type
- UV Resistant Epoxy
- Superior Weather-resistance
- RoHS compliant

■Applications

- Toys & Games
- Decoration
- General Use

■Absolute Maximum Rating (Ta=25 °C)

Item	Symbol	Value	Unit
DC Forward Current	I_F	30	mA
Pulse Forward Current*	I_{FP}	100	mA
Reverse Voltage	V_R	5	V
Power Dissipation	P_D	120	mW
Operating Temperature	T_{opr}	-30~+80	
Storage Temperature	T_{stg}	-30~+100	
Lead Soldering Temperature	T_{sol}	260 /3sec	-

*Pulse width Max.10ms Duty ratio max 1/10

■Electrical -Optical Characteristics (Ta=25 °C)

Item	Symbol	Condition	Min.	Typ.	Max.	Unit
DC Forward Voltage	V_F	$I_F=20mA$	1.8	2.0	2.4	V
DC Reverse Current	I_R	$V_R=5V$	-	-	10	μA
Domi. Wavelength	λ_D	$I_F=20mA$	520	525	530	nm
Luminous Intensity	I_V	$I_F=20mA$	1560	2180	3000	mcd
50% Power Angle	$2\theta_{1/2}$	$I_F=20mA$	-	130	-	deg

*Please refer to CIE 1931 chromaticity diagram.

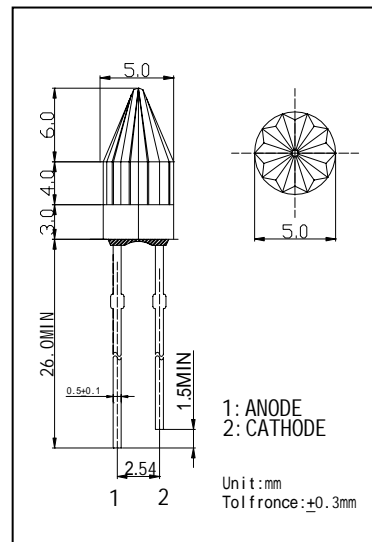
■Outline Dimension

■Directivity
