

# Color click™

## 1. Introduction

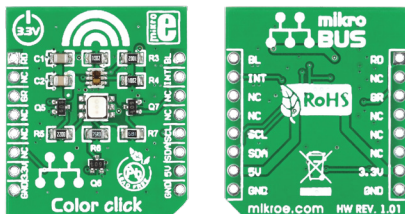

Color click™ is an accessory board in **mikroBUS™** form factor. It's a compact and easy solution for adding red, green, blue and clear light sensing to your design. It features **TCS3471** color RGB light-to-digital converter, three NPN resistor-equipped transistors as well as RGB LED. Color click™ communicates with the target board microcontroller via **mikroBUS™** I<sup>2</sup>C (SDA, SCL), AN, CS, PWM and INT lines. The board is designed to use 3.3V and 5V power supply.

## 2. Soldering the headers

Before using your click board™, make sure to solder 1x8 male headers to both left and right side of the board. Two 1x8 male headers are included with the board in the package.

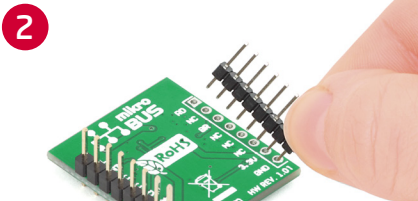
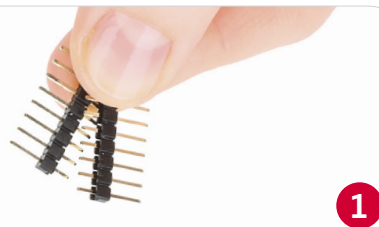

Turn the board upside down to face its bottom side. Place shorter parts of the header pins in both soldering pad locations.

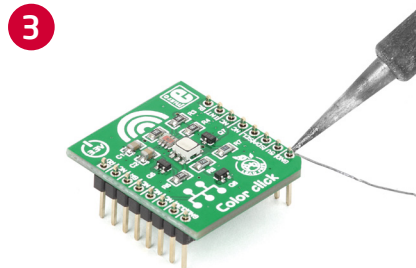

Turn the board upward again. Make sure to align the headers so that they are perpendicular to the board, then solder the pins carefully.

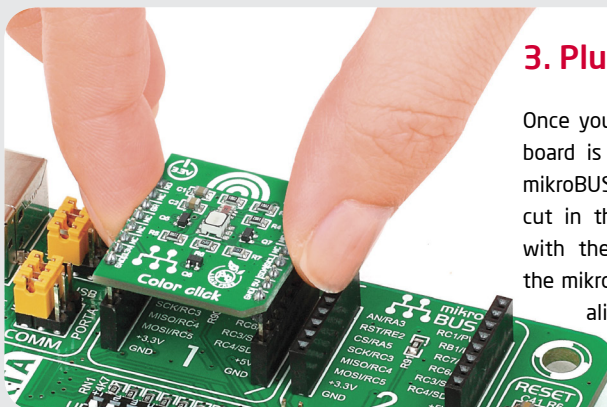

## 3. Plugging the board in

Once you have soldered the headers your board is ready to be placed into desired mikroBUS™ socket. Make sure to align the cut in the lower-right part of the board with the markings on the silkscreen of the mikroBUS™ socket. If all of the pins are aligned correctly, push the board all the way into the socket.

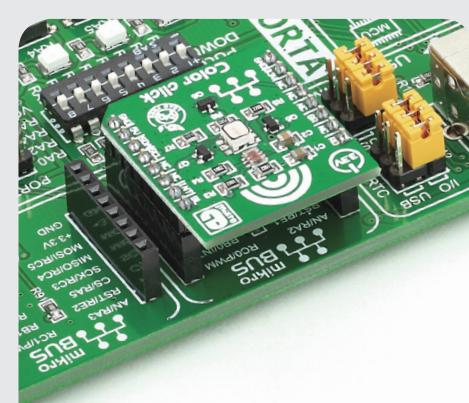

## 4. Essential features

Color click™ with its **TCS3471** IC is a color light sensor that detects light intensity under a variety of lightning conditions. The **TCS3471** contains 4x4 photodiode array, integrating amplifiers, ADCs, accumulators, clocks, buffers, comparators and state machine. RGB LED is provided to help you illuminate the objects if no other light source is available. This board is ideal for RGB LED backlight control, industrial process control, medical diagnostic and many more.



www.mikroe.com

Color click Manual ver. 1.01



0 10000 024294

## 5. Color click™ Board Schematic

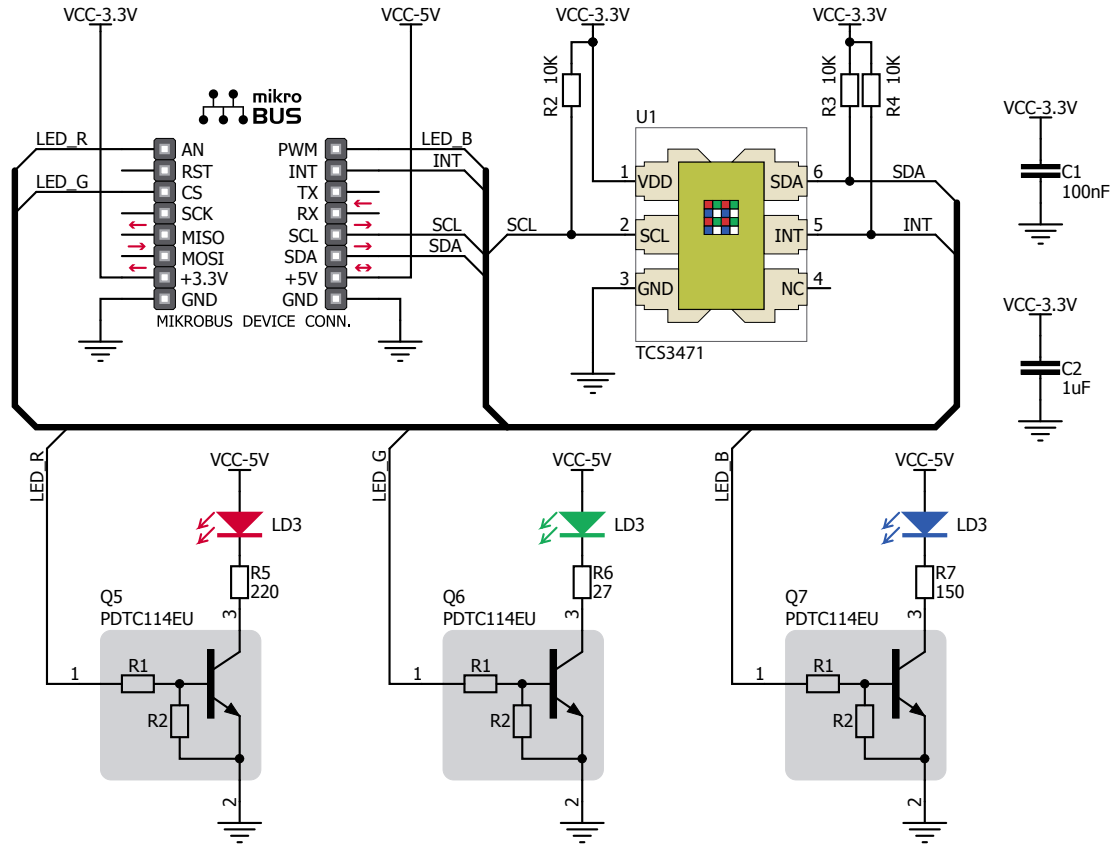

## 6. Interrupt line

Color click™ contains separate pin for level-style interrupts. An interrupt is generated when the value of an RGBC conversion exceeds either an upper or lower threshold (programmable). In addition, a programmable interrupt persistence feature allows you to determine how many consecutive exceeded thresholds are necessary to trigger an interrupt.

## 7. Code Examples

Once you have done all the necessary preparations, it's time to get your click board up and running. We have provided the examples for mikroC, mikroBasic and mikroPascal compilers on our **Libstock** website. Just download them and you are ready to start.



## 8. Support

MikroElektronika offers **Free Tech Support** ([www.mikroe.com/esupport](http://www.mikroe.com/esupport)) until the end of product lifetime, so if something goes wrong, we are ready and willing to help!