

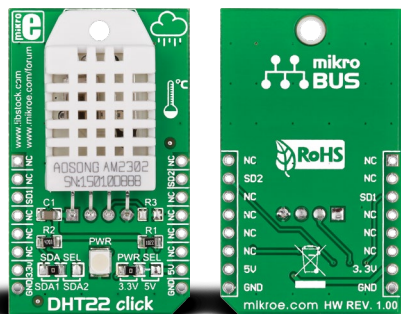

## DHT22 click™

### 1. Introduction



DHT22 click™ is a temperature and humidity measurement board carrying the AM2302 sensor (also known as DHT22). It's a low cost reliable sensor that communicates with the target board microcontroller through a **single Serial Data Line**. You can **choose between the mikroBUS™ CS or INT pins** for communicating with the target board microcontroller. The board is designed to use either a 3.3V or a 5V power supply.

### 2. Soldering the headers

Before using your click™ board, make sure to solder 1x8 male headers to both left and right side of the board. Two 1x8 male headers are included with the board in the package.

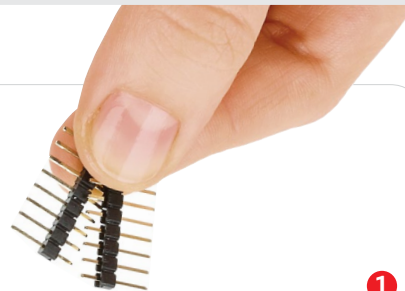

1

2

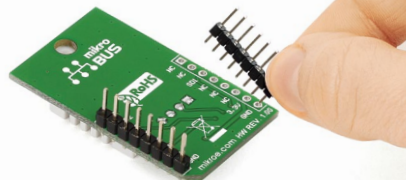

Turn the board upside down so that the bottom side is facing you upwards. Place shorter pins of the header into the appropriate soldering pads.

3

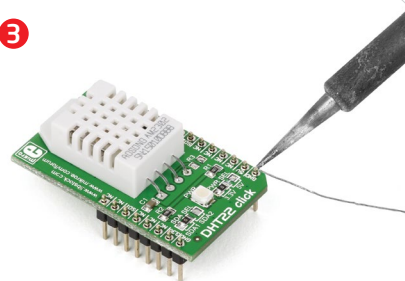

Turn the board upward again. Make sure to align the headers so that they are perpendicular to the board, then solder the pins carefully.

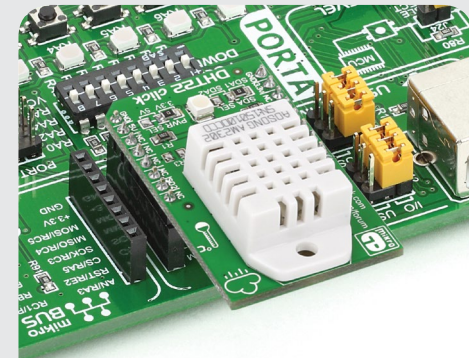

### 4. Essential features

The DHT22 click™ temperature and humidity sensor can detect temperatures between **-40 and 80 degrees centigrade with a half a degree precision (0.5C)**. The relative humidity measurement from **0-100% is accurate within 2%**. Both relative humidity and temperature data signals have a 16Bit resolution. To get accurate data you should set up the interval between individual sensor readings at least two seconds apart.

### 3. Plugging the board in

Once you have soldered the headers your board is ready to be placed into the desired mikroBUS™ socket. Make sure to align the cut in the lower-right part of the board with the markings on the silkscreen at the mikroBUS™ socket. If all the pins are aligned correctly, push the board all the way into the socket.

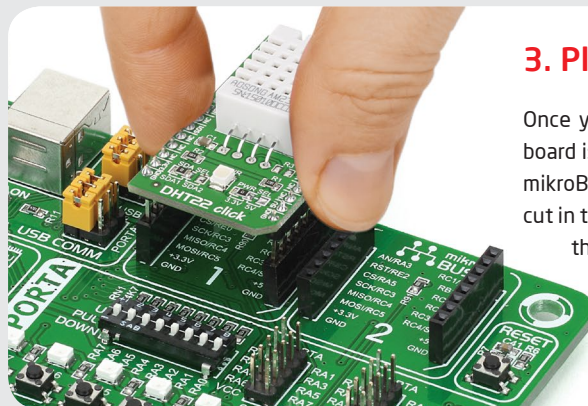

click™  
BOARD  
[www.mikroe.com](http://www.mikroe.com)

DHT22 click™ manual  
ver 1.00



0100000072066

## 5. DHT22 click™ board schematic

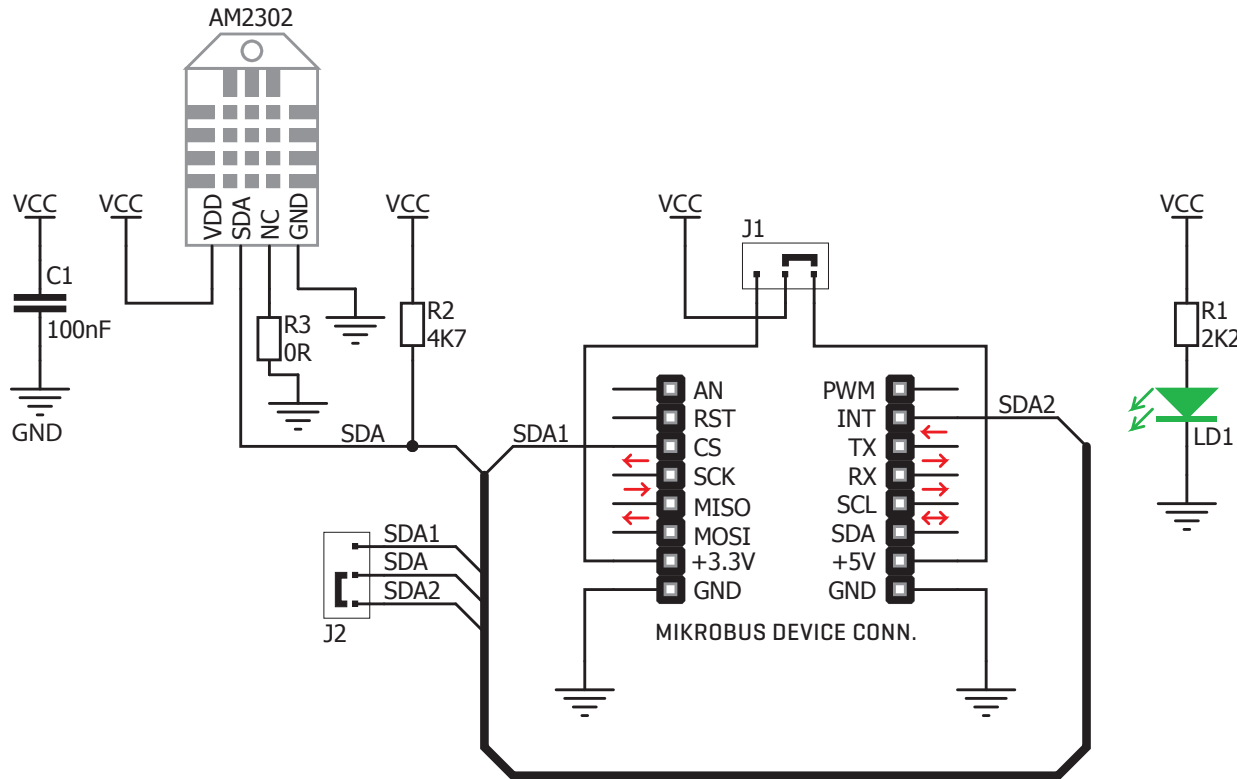

## 6. Jumpers



DHT22 click™ has two jumpers (zero ohm resistors). **SDA SEL** lets you select either CS (SDA1) or INT (SDA2) for outputting the one wire signal. The **PWR SEL** jumper is for choosing between 3.3 and 5V power supplies.

## 7. Code examples

Once you have done all the necessary preparations, it's time to get your click™ board up and running. We have provided examples for mikroC™, mikroBasic™ and mikroPascal™ compilers on our **Libstock** website. Just download them and you are ready to start.



## 8. Support

MikroElektronika offers **free tech support** ([www.mikroe.com/support](http://www.mikroe.com/support)) until the end of the product's lifetime, so if something goes wrong, we're ready and willing to help!