

3.3V

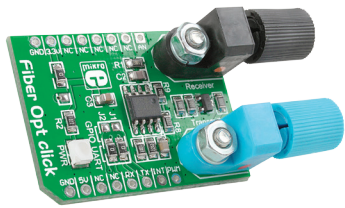

Fiber Opt click™

1. Introduction

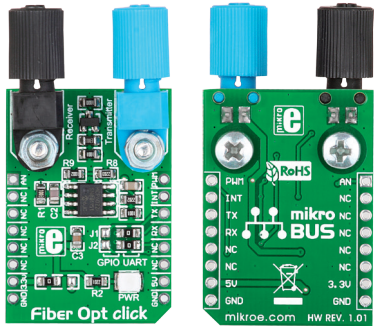

Fiber Opt click™ is an accessory board in **mikroBUS™** form factor. It's a compact and easy solution for adding fiber-optic communication to your design. It features **IF-D91** fiber-optic photodiode, **IF-E97** fiber-optic LED diode as well as two operational amplifiers. Fiber Opt click™ communicates with the target board microcontroller via **mikroBUS™** UART (TX, RX), INT and PWM lines. The board is designed to use 3.3V power supply only. LED diode (GREEN) indicates the presence of power supply.

2. Soldering the headers

Before using your click™ board, make sure to solder 1x8 male headers to both left and right side of the board. Two 1x8 male headers are included with the board in the package.

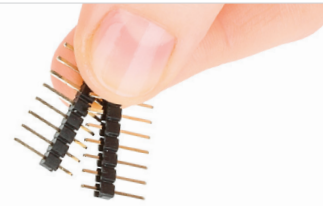

1

2

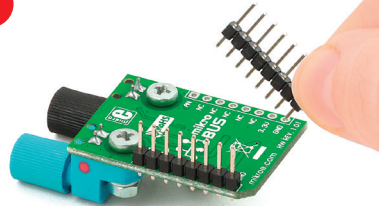

Turn the board upside down so that bottom side is facing you upwards. Place shorter pins of the header into the appropriate soldering pads.

3

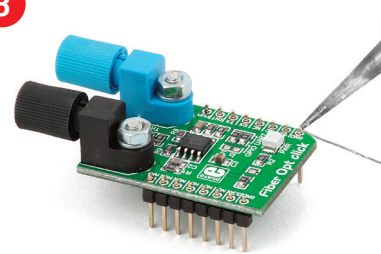

Turn the board upward again. Make sure to align the headers so that they are perpendicular to the board, then solder the pins carefully.

3. Plugging the board in

Once you have soldered the headers your board is ready to be placed into desired mikroBUS™ socket. Make sure to align the cut in the lower-right part of the board with the markings on the silkscreen at the mikroBUS™ socket. If all of the pins are aligned correctly, push the board all the way into the socket.

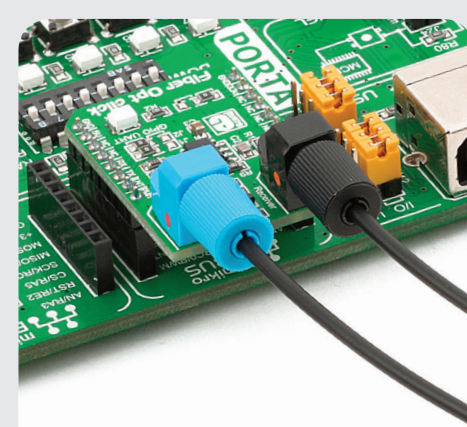
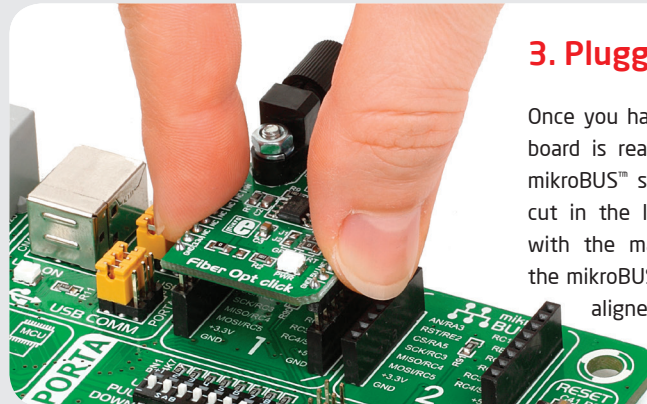

4. Essential features

Fiber Opt click™ with its **IF-D91** and **IF-E97** results in support for fiber-optic communication. Each of the plastic optic connector features an internal micro-lens and a precision-molded PBT housing to ensure efficient optical coupling with plastic fiber cable. The board can achieve data rates up to 512 Kbps. These features make this board ideal for data links, local area networks, motor controller triggering, medical instruments, EMC/EMI signal isolation and many more.

click™
BOARD
www.mikroe.com

Fiber Opt click 3.3V Manual
ver. 1.01



0 100000 023938

5. Fiber Opt click™ Board Schematic

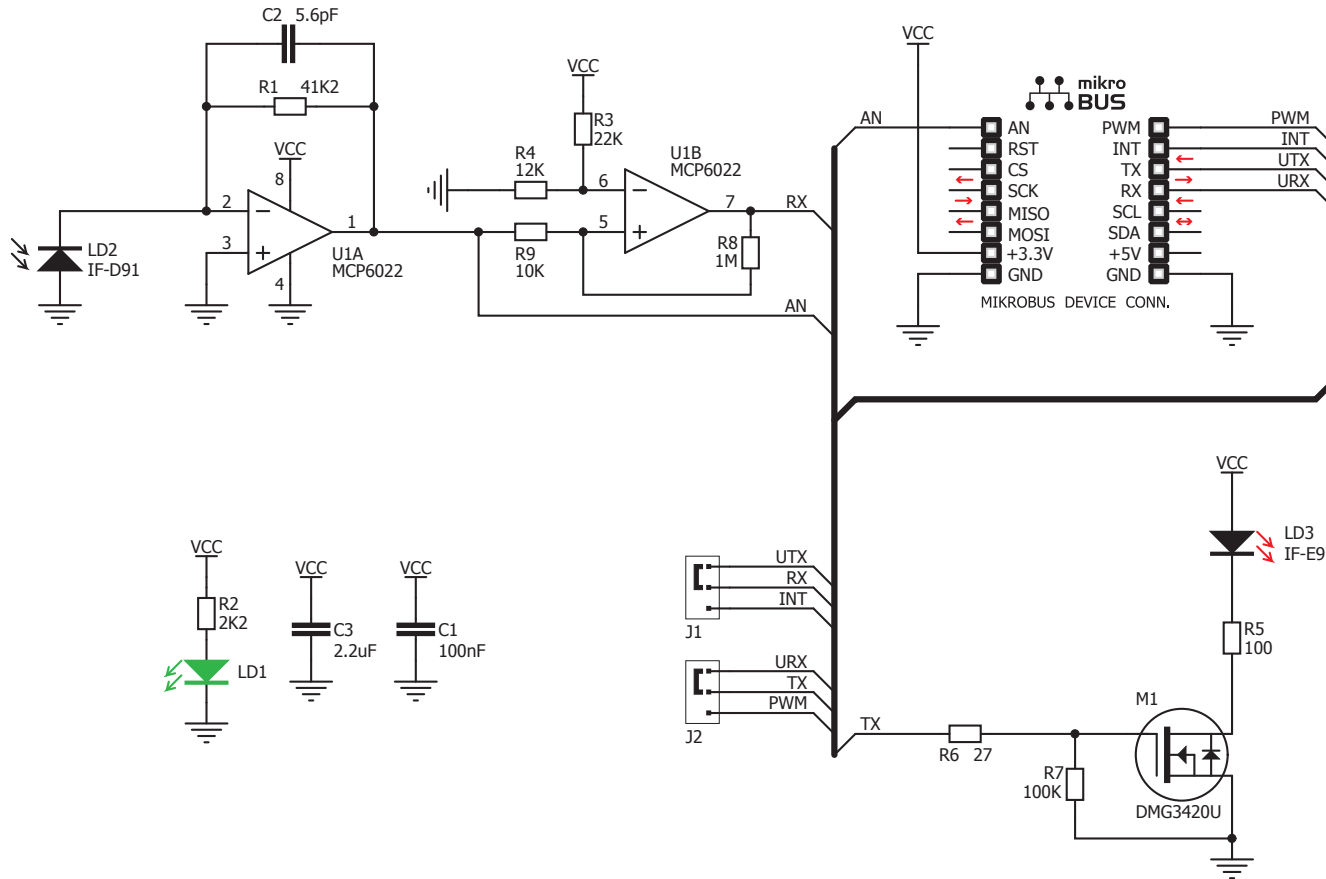

6. SMD jumpers

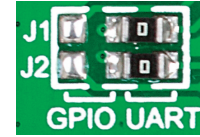

The Fiber Opt Click™ board communicates with the main board microcontroller via UART interface (RX, TX) or directly through the GPIO pins (INT, PWM) depending on the position of the **J1** and **J2** SMD jumpers (UART position by default).

7. Code Examples

Once you have done all the necessary preparations, it's time to get your click™ board up and running. We have provided the examples for mikroC™, mikroBasic™ and mikroPascal™ compilers on our **Libstock** website. Just download them and you are ready to start.



8. Support

MikroElektronika offers **Free Tech Support** (www.mikroe.com/esupport) until the end of product lifetime, so if something goes wrong, we are ready and willing to help!

