



MH-C9000

WizardOne Charger-Analyzer

Thank you for purchasing the Powerex MH-C9000 Charger-Analyzer. Read these instructions carefully and thoroughly before operating this unit. IMPORTANT SAFETY INSTRUCTIONS. READ AND SAVE THESE INSTRUCTIONS.

OPERATING THIS PRODUCT INCORRECTLY CAN CAUSE DAMAGE TO THE BATTERIES. READ MANUAL COMPLETELY BEFORE USE.

GENERAL PRECAUTIONS

- Do not charge battery cells other than NiMH or NiCD. Please check with the battery manufacturer to ensure it can accept the programmed charging and discharging rates. Do not expose the unit to rain or moisture due to the risk of fire.
- Do not operate the charger if it appears damaged in any way.
- Always place the battery cells with positive tip facing the top. Incorrect polarity may cause fire or explosion. Observe polarity diagrams located on the charger.
- Do not allow the unit to be exposed to direct sunlight. Operate in well-ventilated area. Do not place unit on the carpet.
- Do not allow the battery terminals to become shorted.
- To reduce the risk of damage to the power cord, always pull by connector rather than the cord.
- Use only the supplied adapter or optional regional and car adapter offered by Maha Energy. Using third party accessories voids the product warranty.

FEATURES & SPECIFICATIONS

- Four independent slots for AA or AAA NiMH batteries.
- Backlit LCD display.
- Digitally displays capacity, voltage, time and current.
- Five modes of operation: Charge, Refresh & Analyze, Break-In, Discharge and Cycle.
- 19 selectable charging current from 0.2A to 2.0A.
- 10 selectable discharging current from 0.1A to 1.0A.
- Worldwide power supply.

Charging Current:	Programmable from 0.2A to 2.0A in increments of 0.1A
Topoff Charging Current:	100mA
Maintenance Charging Current:	10mA
Discharge Termination:	Voltage 1.00V
Discharging Current:	Programmable from 0.1A to 1.0A in increments of 0.1A
Capacity Storage Memory:	12 (Cycle mode only)

Supported Capacity*:	100 to 20,000mAh
Charger Input Power:	12V 2.0A
Adapter Input:	100-240V 50/60Hz

* Always ensure that the batteries can accept the programmed rates.

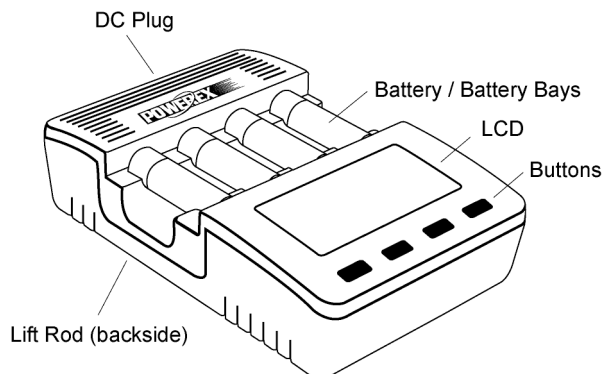

GENERAL BATTERY EDUCATION

What is 0.1C, 0.2C, etc?

“C” stands for the battery capacity and the number in front of it is the fraction of the battery capacity. For example, 0.1C means 0.1 times the capacity for the battery. For a 2700mAh battery, 0.1C would be 0.1 times 2700mAh which equals 270mA.

Choosing the right charging & discharging rate

Charging at a rate below 0.33C and above 1.0C is not recommended.

Charging too slow may prevent the charger from terminating correctly. Charging too fast may damage the battery.

Typically speaking, slower charging rate will yield better battery performance but requires longer time. Faster charging rate may not charge as fully and battery temperature can be higher.

Battery Matching

In most devices, usually two or more batteries are used together. When batteries are used in a series, the performance is limited by the worst one. In other words, one poorly performing battery can significantly reduce the device runtime.

Battery matching refers to grouping batteries with similar “actual” capacity. To perform this, use the Refresh & Analyze mode to determine the battery capacity. Group batteries with capacity within about +/- 5% of the rated capacity.

Battery “Forming”

New batteries and those stored for extended period become chemically deactivated. Battery forming is a charge-discharge-charge cycle which forces a full charge into the battery at a very slow rate. This process activates the battery. In certain cases, it needs to be repeated two or three times.

Battery forming can be performed using the Break-In mode.

MODES OF OPERATION

This section explains various modes and when to use them. To enable each mode, refer to the "Operation" section.

Charge Mode

- Recharges the battery at the selected rate.
- Useful when battery needs to be recharged without determining the capacity of the battery. It should be used on batteries known to be in good condition and have been in continuous use.
- Requires the least amount of time.

Refresh & Analyze Mode

- First recharges the battery, rest for one hour, discharge, rest, then recharges again. Charging and discharging rates are programmable.
- Reports the discharge capacity at the end of the cycle.
- Useful when the battery capacity needs to be determined. Also useful for battery with degraded performance.
- Recommended once every ten cycles for NiMH batteries.

Break-In Mode (IEC capacity analysis)

- Applies a 16-hour 0.1C charge (0.1 times the capacity of the battery), rest of one hour, followed by a 0.2C discharge, rest again, and finally a 16-hour 0.1C recharge again.
- Recommended for brand-new batteries. This process is also known as "Forming Charge." Also recommended with batteries that cannot be rescued by the Refresh & Analyze mode.
- Recommended once every 30 cycles for NiMH batteries.
- Requires 39 to 45 hours to complete.
- The process follows the IEC standard for determining battery capacity.

Discharge Mode

- Discharges the battery at the selected rate.
- Useful for analyzing the amount of charge stored in the battery. Battery not recharged at the end of the cycle.

Cycle Mode

- Performs a charge-discharge cycle for the programmable number of times. Charging and discharging rates are also selectable. At the end of the cycle, a final recharge is applied.
- Suitable for cycling the batteries multiple times.

The following table summarized the recommended mode for typical battery conditions:

Battery Condition	Mode
Brand-new batteries	<i>Break-In</i>
NiMH batteries that have been used frequently (at least once every two weeks)	<i>Charge</i>
Batteries in storage for more than two weeks but less than 3 month	<i>Refresh & Analyze</i>
Batteries in storage for more than 3 month	<i>Break-In</i>
Batteries showing poor performance	<i>Refresh & Analyze for one to three times.</i>

Battery Rescue Steps

For batteries that do not perform favorably after using the mode recommended above, the following sequence can be applied.

- Refresh & Analyze for one to three times.
- If capacity is still low, use Break-In mode.
- If the step 1 to step 2 shows some capacity improvement (> 10%), repeat Break-In mode for one to three times. If no significant improvement, battery probably at end of useful life.

OPERATIONS

- Connect the power adapter DC connector to the charger.

Then, plug the power adapter into a compatible outlet (100-240VAC, 50/60Hz).

TIP: When operating the charger outside of its intended region of use, simply use a plug-changer (Maha part number MHS-TC400 worldwide plug-changer kit). Transformer is not necessary.

- Raise the lift rod located on the backside of the charger.
- Insert AA or AAA battery.

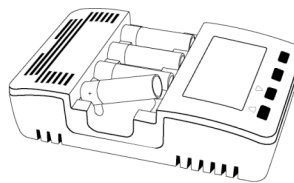

Inserting AA batteries

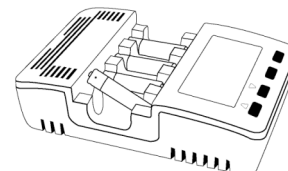

Inserting AAA batteries

TIP: If charging two batteries, inserting them in the first and fourth slot offers better cooling and lowers battery temperature.

- When a new battery is detected, the LCD will display an arrow below the bank number and prompt for the mode by flashing "MODE".

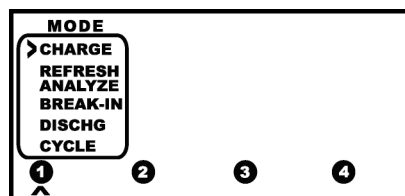

Use the **UP** and **DOWN** arrow keys to choose the desired mode. Press **ENTER** to make the selection.

If no key is pressed within five seconds, the charger will proceed to the default mode which is charging with 1000mA rate.

If more than one battery is inserted at a time (without key press), the charger will prompt for programming in the order in which the batteries were inserted.

- If **CHARGE** mode is selected:

The charger will prompt for the charging rate by flashing "**SET CHG RATE**." Use the **UP** and **DOWN** key to choose the desired current. Press **ENTER** to make the selection. Refer to the "General Battery Education" section on choosing an appropriate rate.

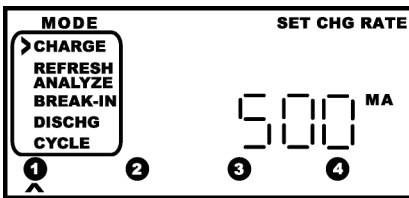

If **REFRESH & ANALYZE** mode is selected:

The charger will prompt for the charging rate by flashing "SET CHG RATE." Use the **UP** and **DOWN** key to choose the desired current. Press **ENTER** to make the selection.

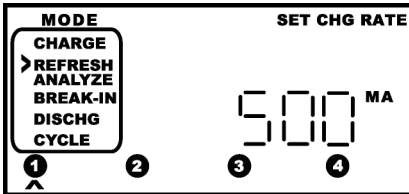

Then it will prompt from the discharging rate by flashing "SET DISCHG RATE." Follow the same procedure as above.

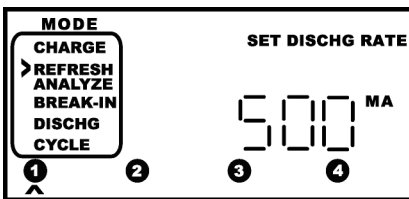

If **BREAK-IN** mode is selected:

The charger will prompt for the battery capacity in order to calculate the charging and discharging rate automatically. "SET BATTERY CAPACITY" will flash. Use the **UP** and **DOWN** key to choose the desired current. Press **ENTER** to make the selection.

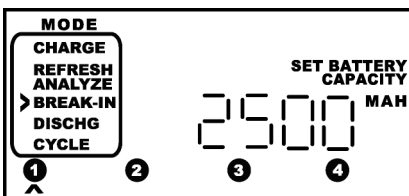

If **DISCHARGE** mode is selected:

The charger will prompt for the discharging rate by flashing "SET DISCHG RATE." Use the **UP** and **DOWN** key to choose the desired current. Press **ENTER** to make the selection.

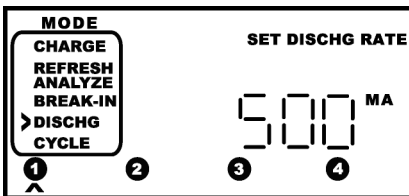

If **CYCLE** mode is selected:

The charger will prompt for the charging rate and discharging rate similar to the other modes. In addition, it will also prompt for the number of cycles to be performed by flashing "SET CYCLES." Use the **UP** and **DOWN** keys to choose the desired cycles. Press **ENTER** to make the selection.

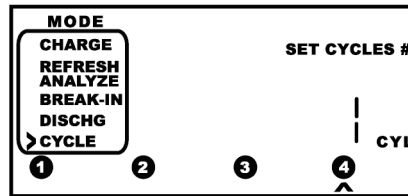
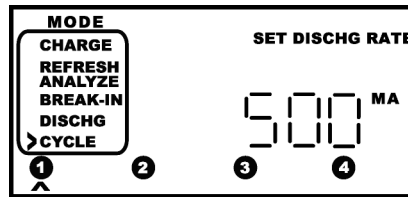
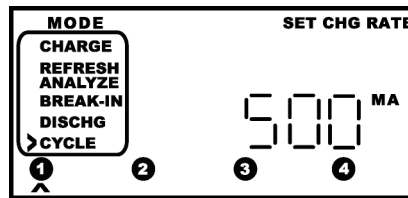

- To ensure safety, the charger performs an "impedance check" at the beginning of the program. If the battery fails this test, "HIGH" would be displayed and program will be terminated.

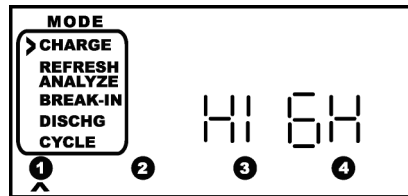

Typically alkaline and extremely aged battery will fail this test. For a rechargeable battery, it is recommended for the battery to be discarded.

NOTE: This test is not performed for the discharge mode.

If this detection is believed to be incorrect, a discharge can be performed first.

- While executing the programmed function, the charger will display the battery status for each occupied slot consecutively. The screen will first show an arrow below the active bank and display the information. The next slot(s) occupied follows.

Press the **SLOT** button at anytime will jump to the next occupied slot. Press this button multiple times if necessary to go to the desired slot.

The following information is displayed on the screen:

Current:

This is the number followed by the unit "MA." This is the approximate charging or discharging current. Note that this number will go up and down due to the pulse charging.

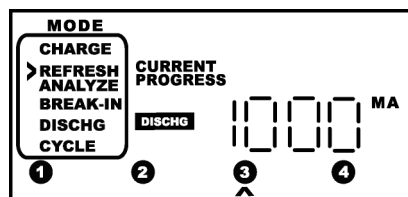

Capacity:

This is the number followed by the unit "MAH." This is the accumulated charging or discharging capacity. If it is charging capacity, "CHARGE" in black box will be shown. If it is discharging capacity, "DISCHG" in black box will be shown.

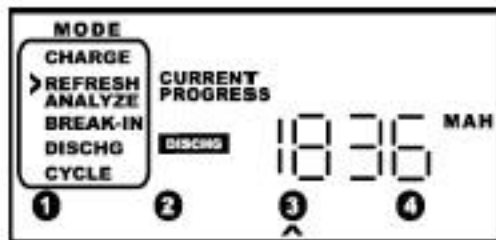

Note the charging capacity is usually higher than the actual capacity of the battery owing to some energy lost as heat. Charging capacity cannot be used to judge the performance the battery. Instead, it can only be used to determine the progress of the charger. It is normal for this number to exceed the actual capacity by as much as 20-30%.

Time:

This is the number followed by the unit "MIN." This is the time elapsed for the particular routine such as charging, discharging or rest in the program.

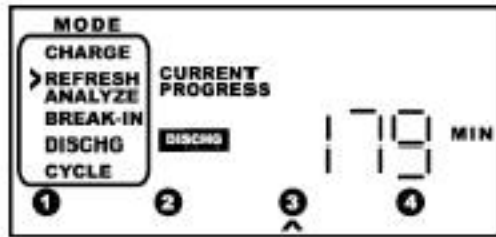

Voltage:

This is the number followed by the unit "VOLT." It represents the offline battery voltage. If you compare this with a voltmeter while charging, the values will not match as a voltmeter is unable to measure the offline battery voltage.

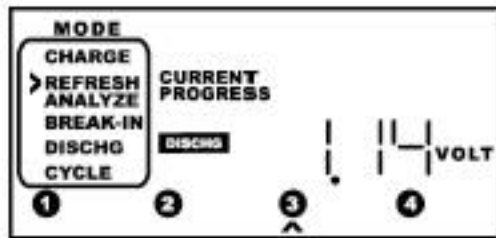

At any given time during the program, the charger will either be charging, discharging or resting. The LCD displays the action in black boxes containing CHARGE, DISCHG, or REST.

- 8. If CYCLE mode is selected, it is also possible to review the battery capacity of finished cycle after the completion of the first cycle.

Press the UP or DOWN key while the active slot is in the cycle mode will display the discharge capacity for that cycle. The LCD will also display "CYCLE HISTORY."

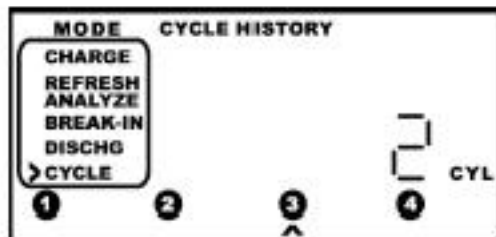

- 9. When the program for a slot is completed, DONE will displayed to the right of the bank number. With the exception of DISCHARGE mode, tophoff charge and trickle charge (continuous) will be applied.

For CHARGE mode, the total charged capacity will be displayed.

For REFRESH & ANALYZE, BREAK-IN, DISCHARGE mode, the total discharge capacity will be displayed. "AVAILABLE CAPACITY" icon will also be shown.

For CYCLE mode, the discharge capacity of the final cycle is displayed. "CYCLE HISTORY" icon will also be shown. Use the UP and DOWN key to access discharge capacity for all the cycles performed.

The capacity information will be stored as long as the battery is inserted in the charger. It will be lost upon removal of the battery.