

V _{RSM}	V _{RRM}	I _{FRMS} (maximum value for continuous operation)		
		24 A ²⁾ ; 28 A ³⁾	24 A ²⁾ ; 28 A ³⁾	60 A
V	V	I _{FAV} (sin. 180; T _{case} = 71 °C)		
		17,5 A ³⁾	17,5 A ³⁾	38 A
500	400	–	SKKE 15/04	–
700	600	SKKD 15/06	SKKE 15/06	–
900	800	SKKD 15/08	SKKE 15/08	–
1300	1200	SKKD 15/12	SKKE 15/12	SKKD 26/12
1500	1400	SKKD 15/14	SKKE 15/14	SKKD 26/14
1700	1600	SKKD 15/16	SKKE 15/16	SKKD 26/16

Rectifier Diode Modules

SEMIPACK® 0
SKKD 15 SKKE 15

SEMIPACK® 1
SKKD 26

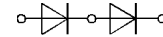
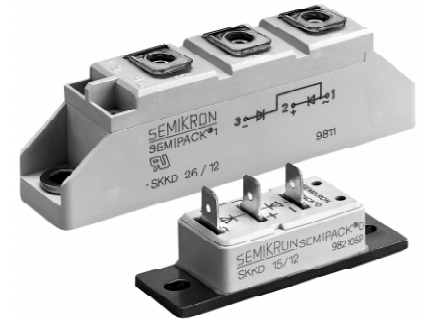

SKKD



SKKE

Symbol	Conditions	SKKD 15 SKKE 15	SKKD 26	Units	
I _{FAV}	sin. 180 (T _{case} = . . .)	15 (82 °C) –	26 (93 °C) 31 (85 °C)	A A	
I _D ¹⁾	B2/B6 T _{amb} = 45 °C; P 13A/125 P 3/120 P 3/180	18 / 22,5 – –	– 44 / 48 53 / 59	A A A	
I _{FSM}	T _{vj} = 25 °C; 10 ms T _{vj} = 125 °C; 10 ms	320 280	550 480	A A	
i ² t	T _{vj} = 25 °C; 8,3 ... 10 ms T _{vj} = 125 °C; 8,3 ... 10 ms	510 390	1 500 1 150	A ² s A ² s	
I _{RD}	T _{vj} = 125 °C, V _{RD} = V _{RRM}	2,5	3	mA	
V _F	T _{vj} = 25 °C; I _F = 75 A; max.	1,85	1,35	V	
V _(TO)	T _{vj} = 125 °C	0,85	0,85	V	
r _T	T _{vj} = 125 °C	15	6	mΩ	
R _{thjc} R _{thch}	} per diode / per module ¹⁾	2,0 / 1,0 0,2 / 0,1	1,0 / 0,5 0,2 / 0,1	°C/W °C/W	
T _{vj} T _{stg}		– 40 ... + 125 – 40 ... + 125		°C °C	
V _{isol}	a. c. 50 Hz; r.m.s.; 1 s/1 min	3600 / 3000		V~	
M ₁	to heatsink	} SI (US) units	1,5 (13 lb. in.) ± 15 %	5 (44 lb. in.) ± 15 %	Nm
M ₂	to terminals		–	3 (26 lb.in.) ± 15 %	Nm
a w	approx.		5 · 9,81 50	5 · 9,81 95	m/s ² g
Case	→ page B 1 – 30	SKKD 15: A 3 SKKE 15: A 4			
	→ page B 1 – 95		A 10		

Features

- Heat transfer through aluminium oxide ceramic isolated metal baseplate
- Hard soldered joints for high reliability
- UL recognized, file no. E 63 532

Typical Applications

- Non-controllable rectifiers for AC/AC converters
- Line rectifiers for transistorized AC motor controllers
- Field supply for DC motors
- SKKE: Free-wheeling diodes

¹⁾ SKKD types only

²⁾ Using tin plated connectors with flexible leads of 6 mm² for the main terminals

³⁾ Flexible leads of 6 mm² soldered to the main terminals

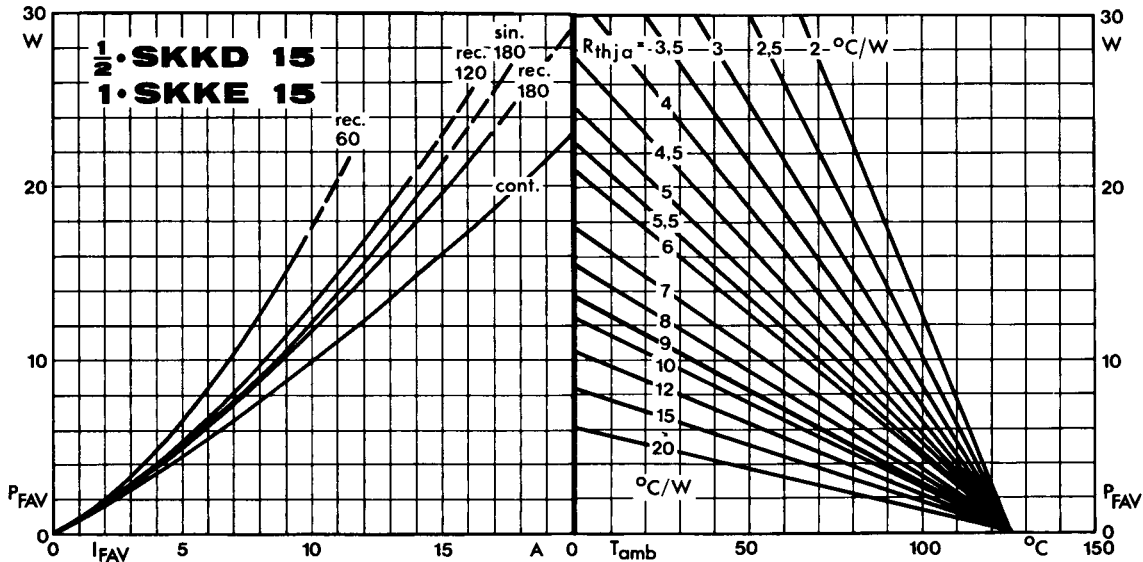

Fig. 11 a Power dissipation per diode vs. forward current and ambient temperature

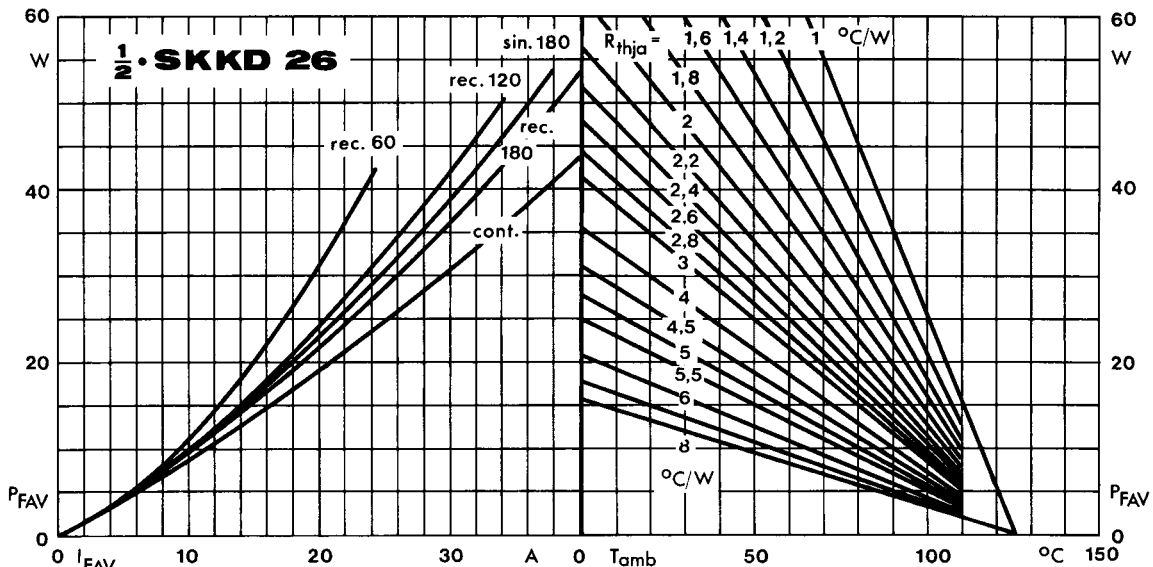

Fig. 11 b Power dissipation per diode vs. forward current and ambient temperature

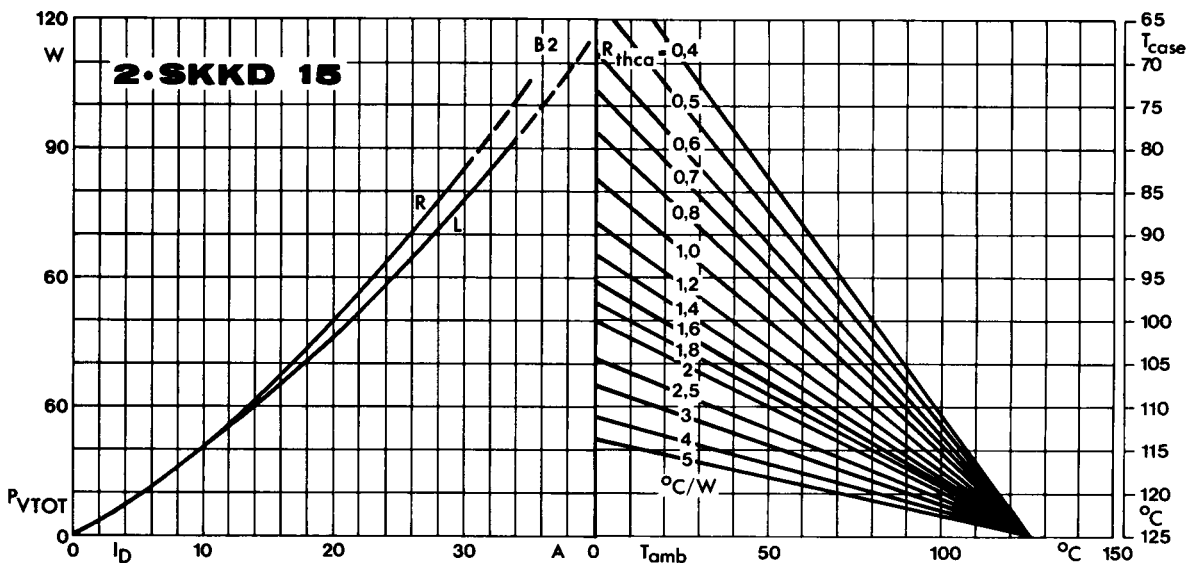

Fig. 12 a Power dissipation of two modules vs. direct current and case temperature

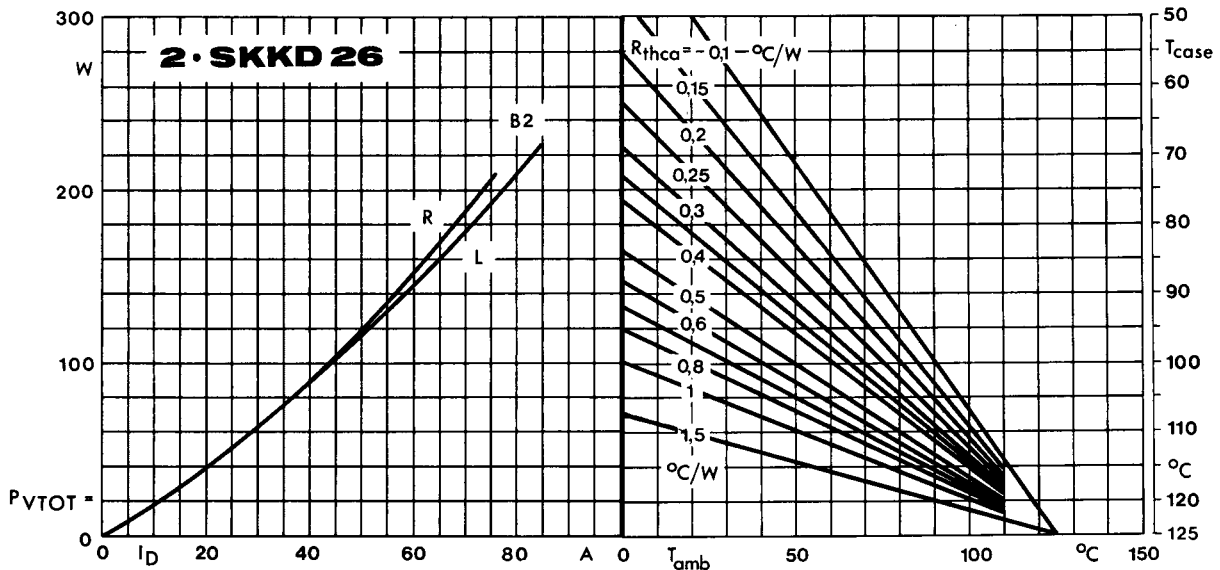

Fig. 12 b Power dissipation of two modules vs. direct current and case temperature

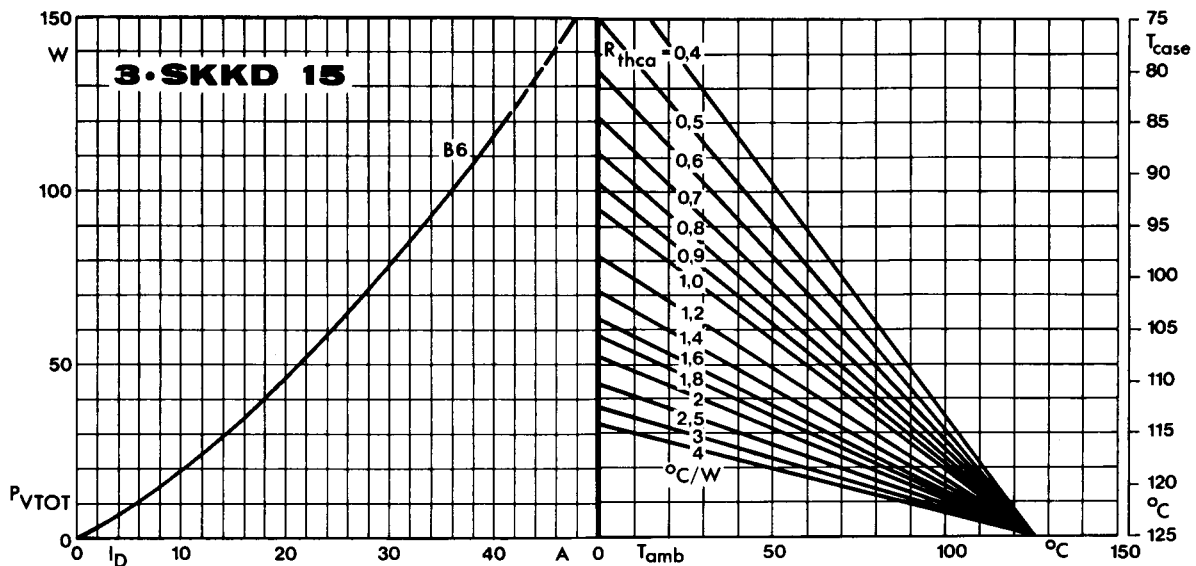

Fig. 13 a Power dissipation of three modules vs. direct current and case temperature

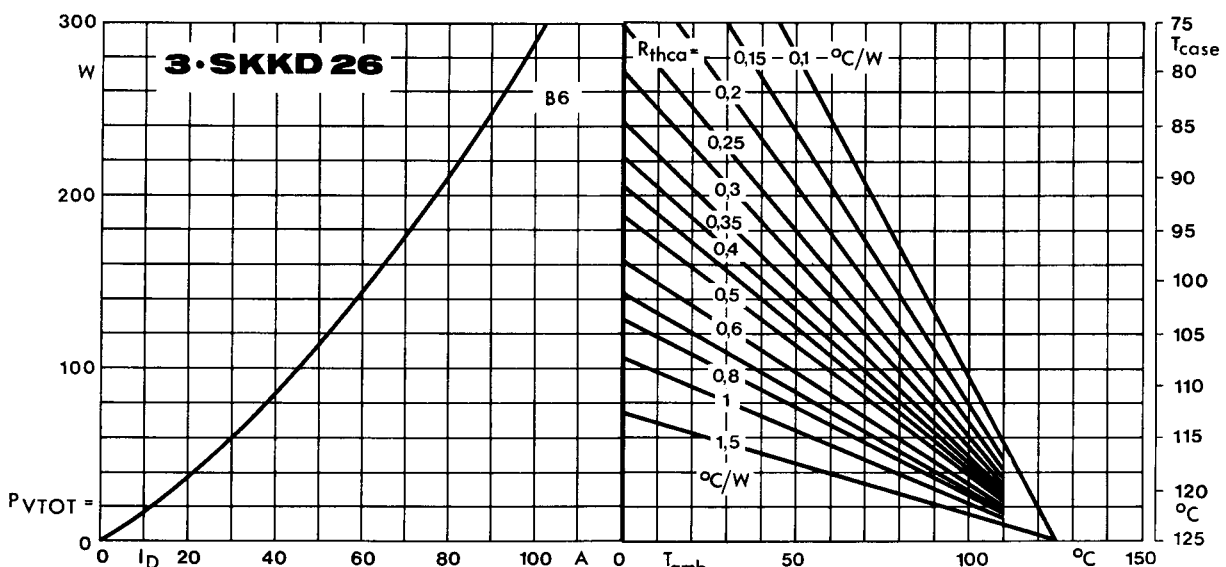

Fig. 13 b Power dissipation of three modules vs. direct current and case temperature

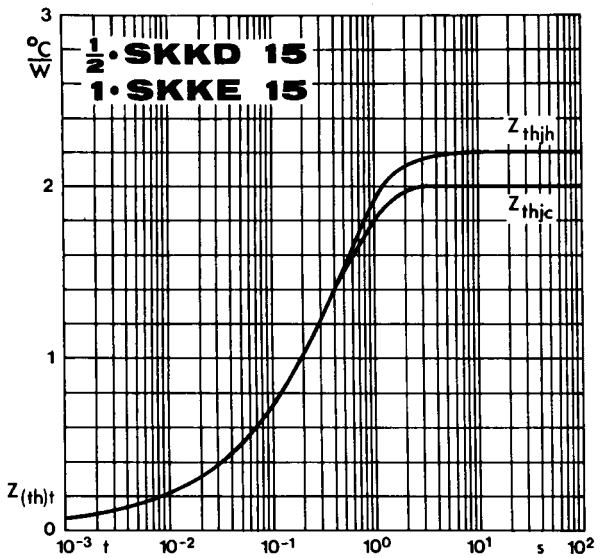

Fig. 14 a Transient thermal impedance vs. time

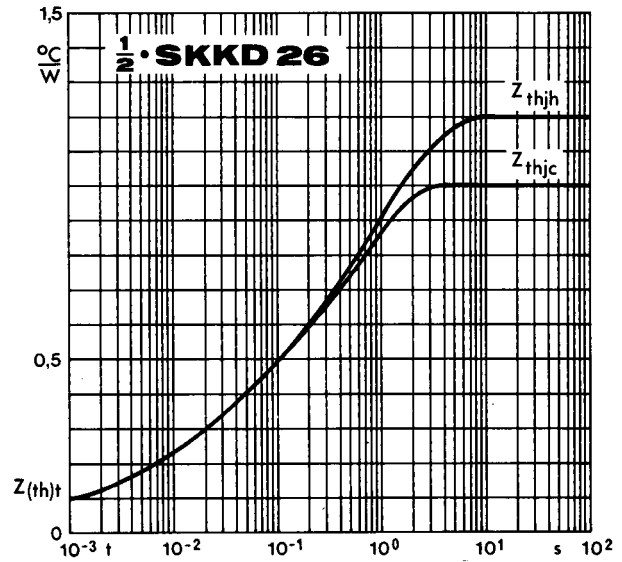

Fig. 14 b Transient thermal impedance vs. time

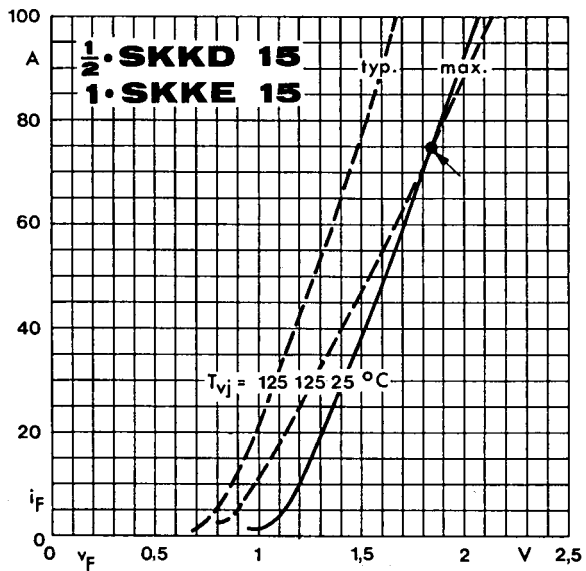

Fig. 15 a Forward characteristics

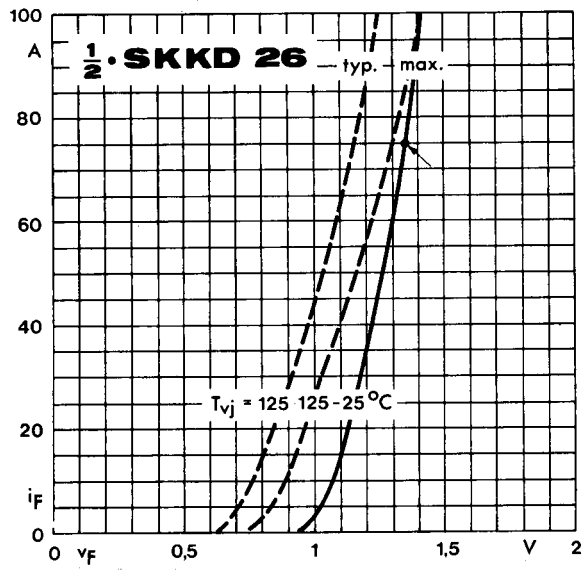

Fig. 15 b Forward characteristics

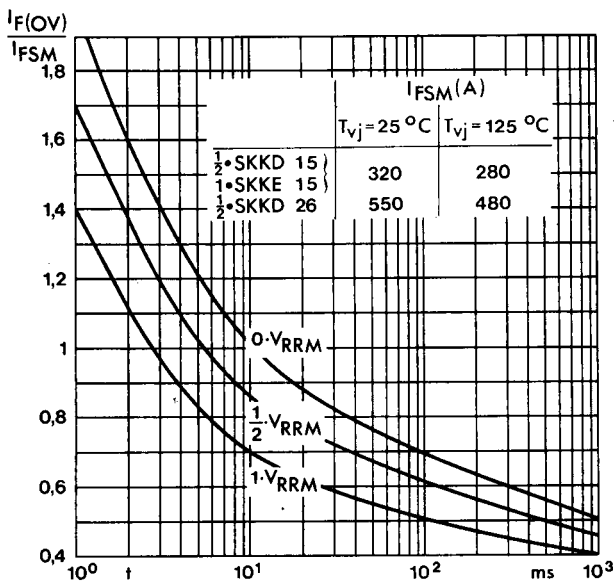

Fig. 16 Surge overload current vs. time

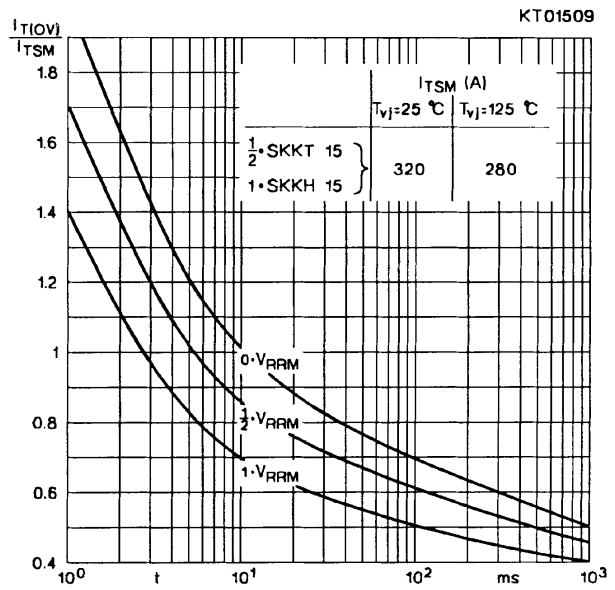
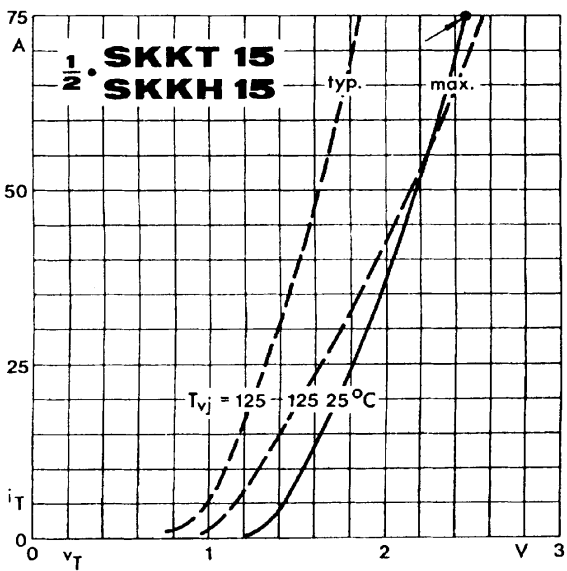

Fig. 8 On-state characteristics

Fig. 9 Surge overload current vs. time

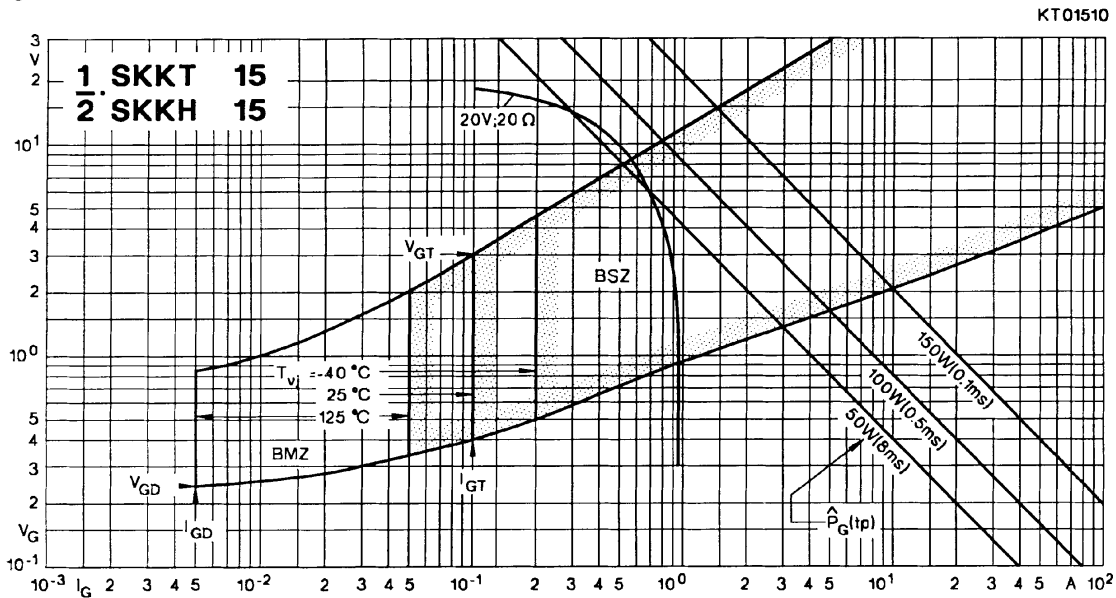
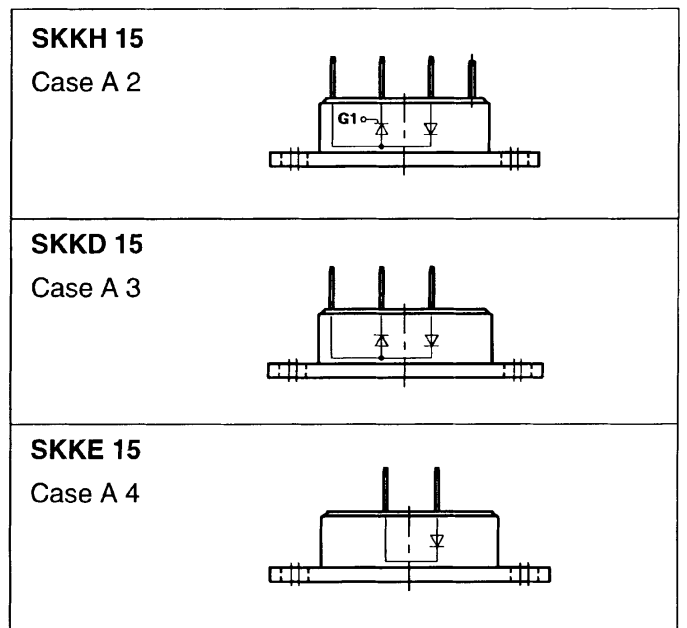
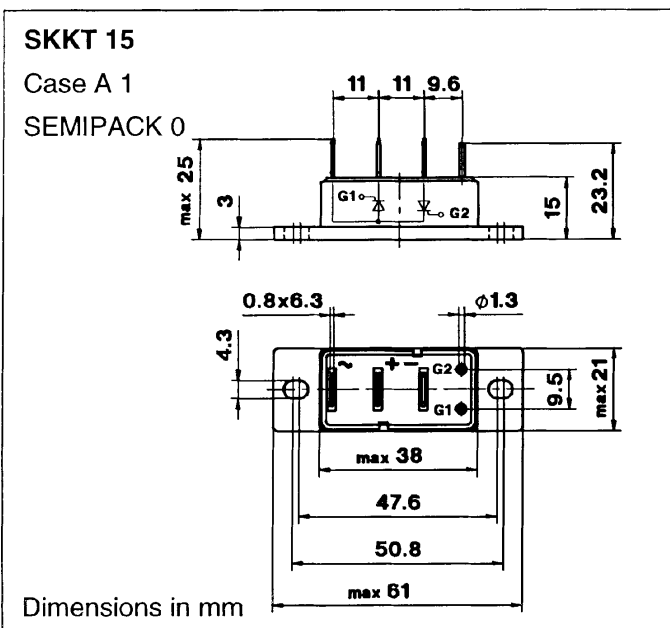

Fig. 10 Gate trigger characteristics



SKKT 19 ... 105

Case A 5

IEC 192-2: A 77 A

JEDEC: TO-240 AA

SEMIPACK® 1

UL recognized, file no. E 63 532

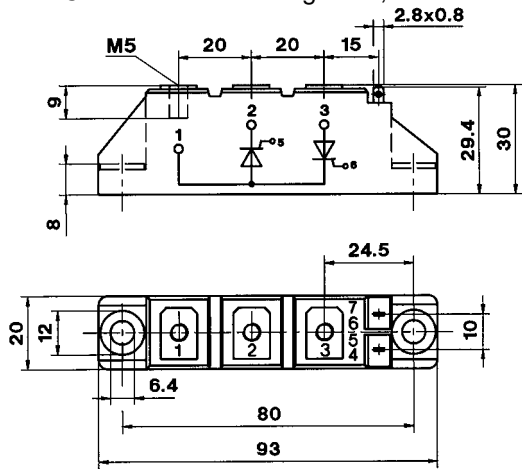

Dimensions in mm

SKKT 20/ ... 106/

Case A 46

IEC 192-2: A 77 A

JEDEC: TO-240 AA

SEMIPACK® 1

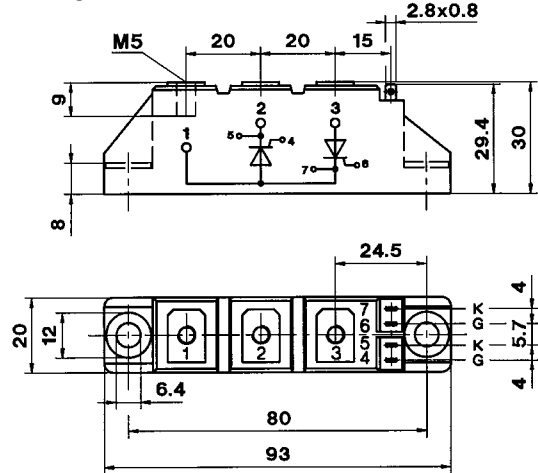

Dimensions in mm

SKKH 26 ... 105

Case A 6

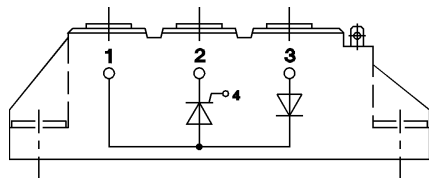

SKKD 26 ... 100

Case A 10

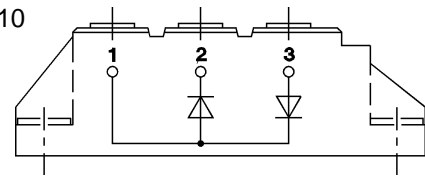

SKNH 56 ... 91

Case A 7

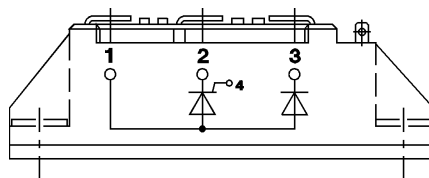

SKKE 81

Case A 12

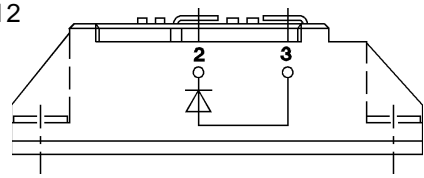

SKKL 56 ... 105

Case A 9

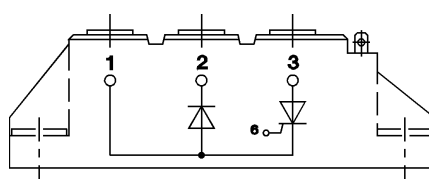

SKKH 27 ... 106

Case A 47

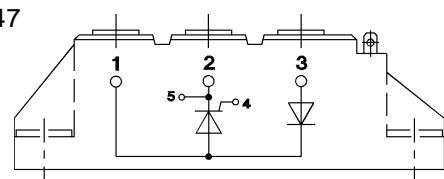

SKND 46 ... 81

Case A 19

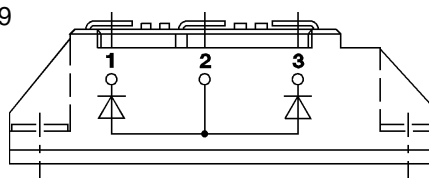

SKKT 20 B ... 106 B

Case A 48

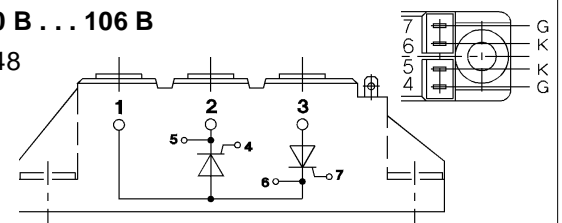

SKMT 92

Case A 72

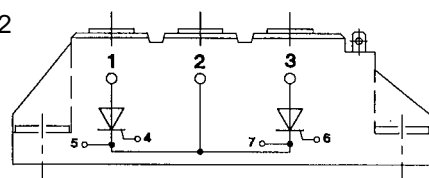

SKKL 42 ... 106

Case A 59

