

# CR2016

3V Lithium Battery  
Swiss Made

## Technical Data Sheet

### Specifications

Chemical System	Li / MnO <sub>2</sub>
Nominal Voltage	3 V
Rated Capacity	80 mAh
Standard Discharge Current	0,2 mA
Max. Cont. Discharge Current	3,5 mA
Average Weight	1,7 g
Temperature Range	-30 - +70 °C
Self Discharge at 23°C	< 1% / year

### Dimensions

(According to IEC 60086)

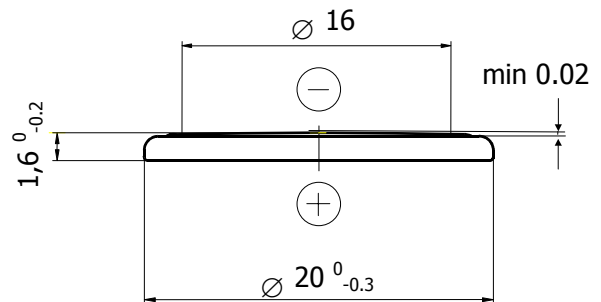

### Performance

Discharge performance at 23°C

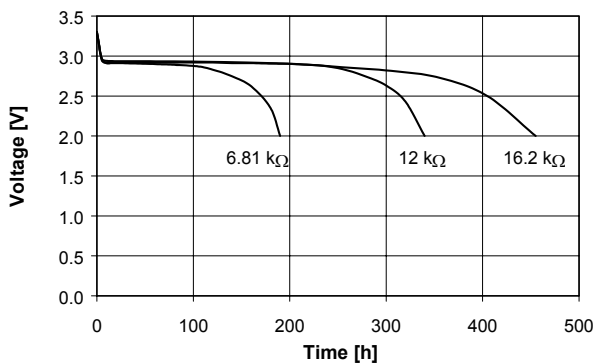

Discharge performance at 23°C

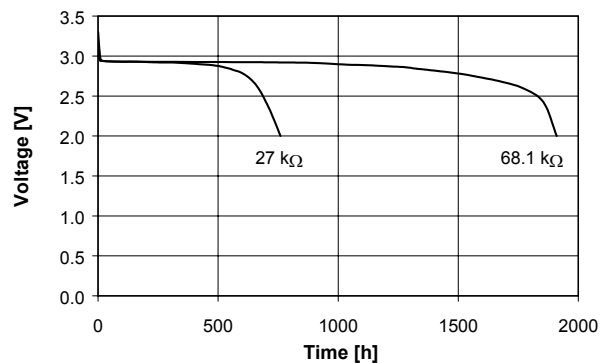

Temperature performance Load 27kΩ

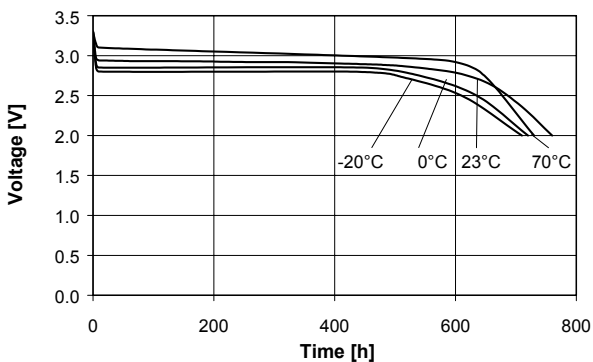

Cell capacity at various loads

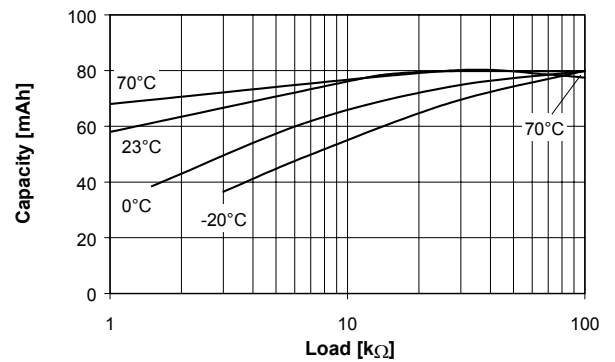

Rev. CR2016.04 10/01