

CD4514B, CD4515B Types

CMOS 4-Bit Latch/4-to-16 Line Decoders

High-Voltage Types (20-Volt Rating)
CD4514B Output "High" on Select
CD4515B Output "Low" on Select

■ CD4514B and -CD4515B consist of a 4-bit strobed latch and a 4-to-16-line decoder. The latches hold the last input data presented prior to the strobe transition from 1 to 0. Inhibit control allows all outputs to be placed at 0 (CD4514B) or 1 (CD4515B) regardless of the state of the data or strobe inputs.

The decode truth table indicates all combinations of data inputs and appropriate selected outputs.

These devices are similar to industry types MC14514 and MC14515.

The CD4514B and CD4515B types are supplied in 16-lead hermetic dual-in-line ceramic packages (F3A suffix), 16-lead dual-in-line plastic packages (E suffix), and 16-lead small-outline packages (M and M96 suffixes).

Features:

- Strobed input latch
- Inhibit control
- 100% tested for quiescent current at 20 V
- Maximum input current of 1 μ A at 18 V over full package-temperature range; 100 nA at 18 V and 25°C
- Noise margin (over full package temperature range):
 - 1 V at $V_{DD} = 5$ V
 - 2 V at $V_{DD} = 10$ V
 - 2.5 V at $V_{DD} = 15$ V
- 5-V, 10-V, and 15-V parametric ratings
- Standardized, symmetrical output characteristics.
- Meets all requirements of JEDEC Tentative Standard No. 13B; "Standard Specifications for Description of 'B' Series CMOS Devices"

Applications:

- Digital multiplexing
- Address decoding
- Hexadecimal/BCD decoding
- Program-counter decoding
- Control decoder

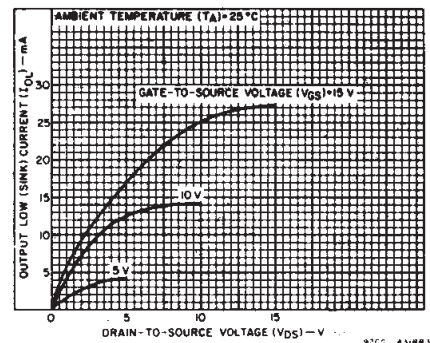
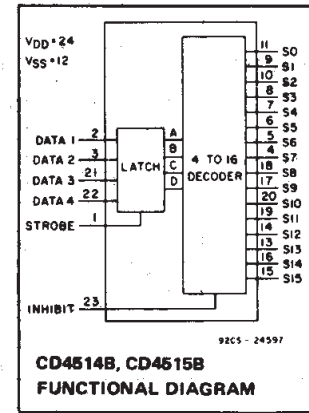

Fig. 1 – Typical output low (sink) current characteristics.

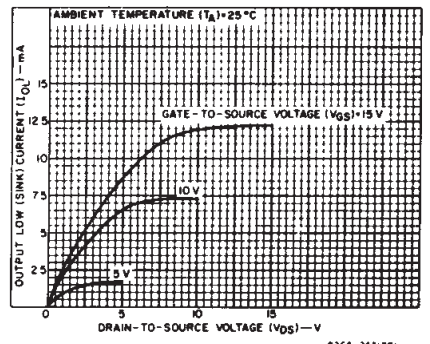

Fig. 2 – Minimum output low (sink) current characteristics.

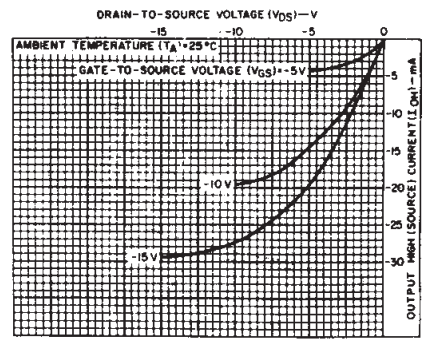

Fig. 3 – Typical output high (source) current characteristics.

MAXIMUM RATINGS, Absolute-Maximum Values:

DC SUPPLY-VOLTAGE RANGE, (V_{DD})	-0.5V to +20V
Voltages referenced to V_{SS} Terminal	
INPUT VOLTAGE RANGE, ALL INPUTS	-0.5V to $V_{DD} + 0.5V$
DC INPUT CURRENT, ANY ONE INPUT	± 10 mA
POWER DISSIPATION PER PACKAGE (P_D):	
For $T_A = -55^\circ\text{C}$ to $+100^\circ\text{C}$	500 mW
For $T_A = +100^\circ\text{C}$ to $+125^\circ\text{C}$	Derate Linearly at 12 mW/ $^\circ\text{C}$ to 200 mW
DEVICE DISSIPATION PER OUTPUT TRANSISTOR	
FOR $T_A =$ FULL PACKAGE-TEMPERATURE RANGE (All Package Types)	100 mW
OPERATING-TEMPERATURE RANGE (T_A)	-55°C to $+125^\circ\text{C}$
STORAGE TEMPERATURE RANGE (T_{stg})	-65°C to $+150^\circ\text{C}$
LEAD TEMPERATURE (DURING SOLDERING):	
At distance 1/16 \pm 1/32 inch (1.59 \pm 0.79 mm) from case for 10s max	$+265^\circ\text{C}$

RECOMMENDED OPERATING CONDITIONS at $T_A = 25^\circ\text{C}$, Except as Noted.

For maximum reliability, nominal operating conditions should be selected so that operation is always within the following ranges:

CHARACTERISTIC	V_{DD} (V)	LIMITS		UNITS
		Min.	Max.	
Supply-Voltage Range (For $T_A =$ Full Package-Temperature Range)		3	18	V
Data Setup Time, t_S	5 10 15	150 70 40	— — —	ns
Strobe Pulse Width, t_W	5 10 15	250 100 75	— — —	ns

3
COMMERCIAL CMOS
HIGH VOLTAGE ICs

CD4514B, CD4515B Types

STATIC ELECTRICAL CHARACTERISTICS

CHARACTERISTIC	CONDITIONS			LIMITS AT INDICATED TEMPERATURES (°C)							UNITS
	V _O (V)	V _{IN} (V)	V _{DD} (V)	-55	-40	+85	+125	+25			
								Min.	Typ.	Max.	
Quiescent Device Current, I _{DD} Max.	-	0.5	5	5	5	150	150	-	0.04	5	μA
	-	0.10	10	10	10	300	300	-	0.04	10	
	-	0.15	15	20	20	600	600	-	0.04	20	
	-	0.20	20	100	100	3000	3000	-	0.08	100	
Output Low (Sink) Current I _{OL} Min.	0.4	0.5	5	0.64	0.61	0.42	0.36	0.51	1	-	mA
	0.5	0.10	10	1.6	1.5	1.1	0.9	1.3	2.6	-	
	1.5	0.15	15	4.2	4	2.8	2.4	3.4	6.8	-	
Output High (Source) Current, I _{OH} Min.	4.6	0.5	5	-0.64	-0.61	-0.42	-0.36	-0.51	-1	-	mA
	2.5	0.5	5	-2	-1.8	-1.3	-1.15	-1.6	-3.2	-	
	9.5	0.10	10	-1.6	-1.5	-1.1	-0.9	-1.3	-2.6	-	
	13.5	0.15	15	-4.2	-4	-2.8	-2.4	-3.4	-6.8	-	
Output Voltage: Low-Level, V _{OL} Max.	-	0.5	5	0.05				-	0	0.05	V
	-	0.10	10	0.05				-	0	0.05	
	-	0.15	15	0.05				-	0	0.05	
Output Voltage: High-Level, V _{OH} Min.	-	0.5	5	4.95				4.95	5	-	V
	-	0.10	10	9.95				9.95	10	-	
	-	0.15	15	14.95				14.95	15	-	
Input Low Voltage, V _{IL} Max.	0.5, 4.5	-	5	1.5				-	-	1.5	V
	1, 9	-	10	3				-	-	3	
	1.5, 13.5	-	15	4				-	-	4	
Input High Voltage, V _{IH} Min.	0.5, 4.5	-	5	3.5				3.5	-	-	V
	1, 9	-	10	7				7	-	-	
	1.5, 13.5	-	15	11				11	-	-	
Input Current I _{IN} Max.	-	0.18	18	±0.1	±0.1	±1	±1	-	±10 ⁻⁵	±0.1	μA

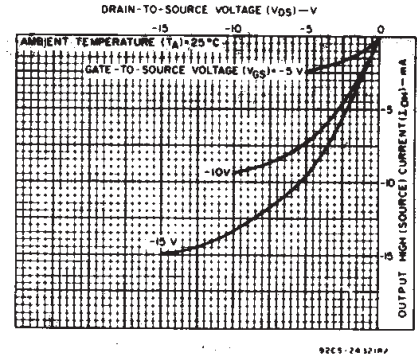

Fig. 4 - Minimum output high (source) current characteristics.

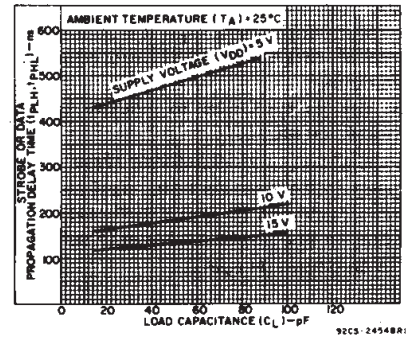

Fig. 5 - Typical strobe or data propagation delay time vs. load capacitance.

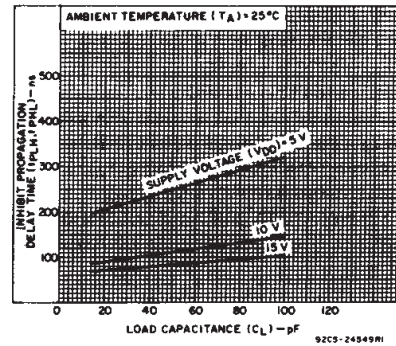

Fig. 6 - Typical inhibit propagation delay time vs. load capacitance.

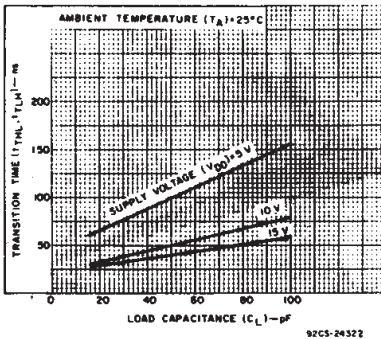

Fig. 7 - Typical low-to-high transition time vs. load capacitance.

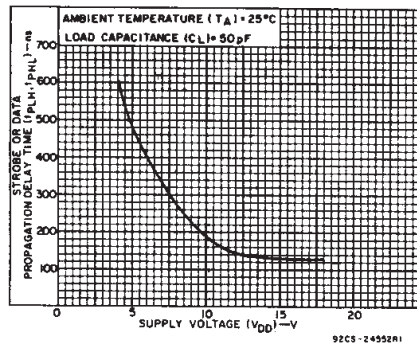

Fig. 8 - Typical strobe or data propagation delay time vs. supply voltage.

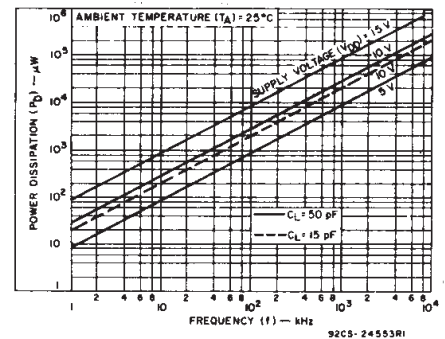

Fig. 9 - Typical power dissipation vs. frequency.

CD4514B, CD4515B Types

DYNAMIC ELECTRICAL CHARACTERISTICS at $T_A = 25^\circ\text{C}$; Input $t_r, t_f = 20\text{ ns}$, $C_L = 50\text{ pF}$, $R_L = 200\text{ K}\Omega$

CHARACTERISTIC	TEST CONDITIONS	LIMITS			UNITS
		VDD V	Typ.	Max.	
Propagation Delay Time: t_{PHL} , t_{PLH} Strobe or Data		5	485	970	ns
		10	185	370	
		15	135	270	
Inhibit		5	250	500	ns
		10	110	220	
		15	85	170	
Transition Time, t_{TLH} , t_{THL}		5	100	200	ns
		10	50	100	
		15	40	80	
Minimum Strobe Pulse Width, t_W		5	125	250	ns
		10	50	100	
		15	40	75	
Minimum Data Setup Time, t_S		5	75	150	ns
		10	35	70	
		15	20	40	
Input Capacitance, C_{IN}	Any Input	—	5	7.5	pF



Fig. 10 — Quiescent device current test circuit.

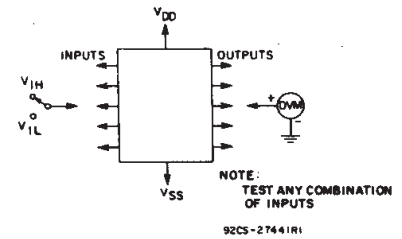

Fig. 11 — Input voltage test circuit.

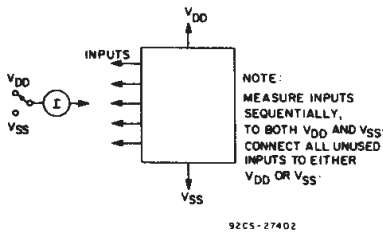

Fig. 12 — Input current test circuit.

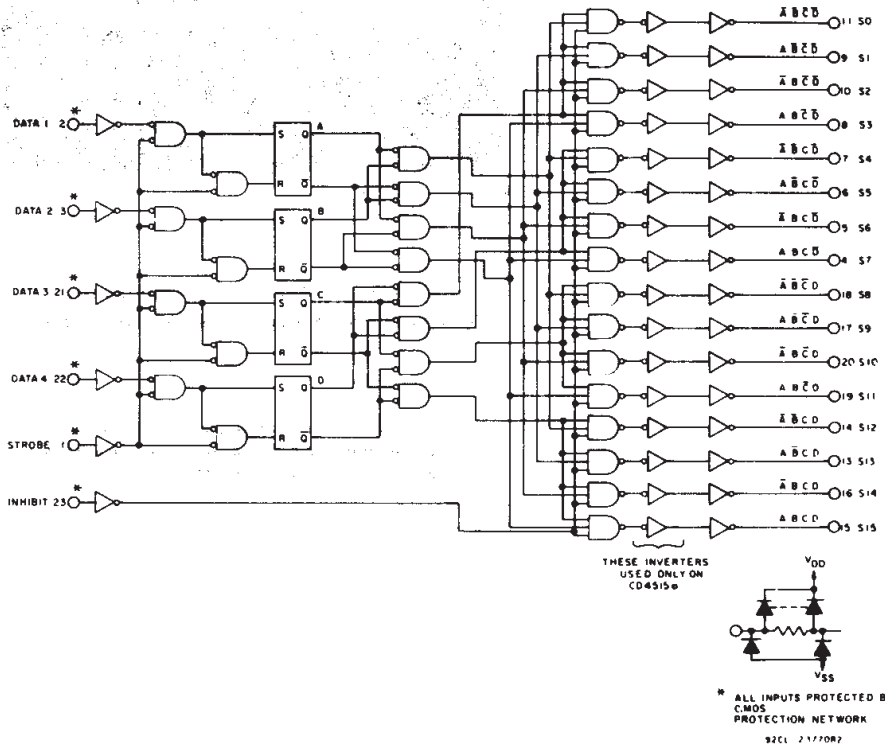

Fig. 13 — Logic diagram for CD4514B and CD4515B.

3
COMMERCIAL CMOS
HIGH VOLTAGE ICs

CD4514B, CD4515B Types

DECODE TRUTH TABLE (Strobe = 1)

INHIBIT	DECODER INPUTS				SELECTED OUTPUT	
	D	C	B	A	CD4514B = Logic 1 (High)	CD4515B = Logic 0 (Low)
0	0	0	0	0	S0	
0	0	0	0	1	S1	
0	0	0	1	0	S2	
0	0	0	1	1	S3	
0	0	1	0	0	S4	
0	0	1	0	1	S5	
0	0	1	1	0	S6	
0	0	1	1	1	S7	
0	1	0	0	0	S8	
0	1	0	0	1	S9	
0	1	0	1	0	S10	
0	1	0	1	1	S11	
0	1	1	0	0	S12	
0	1	1	0	1	S13	
0	1	1	1	0	S14	
0	1	1	1	1	S15	
1	X	X	X	X	All Outputs = 0, CD4514B All Outputs = 1, CD4515B	

X = Don't Care Logic 1 = high Logic 0 = low

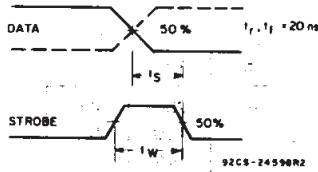
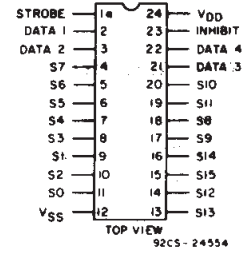
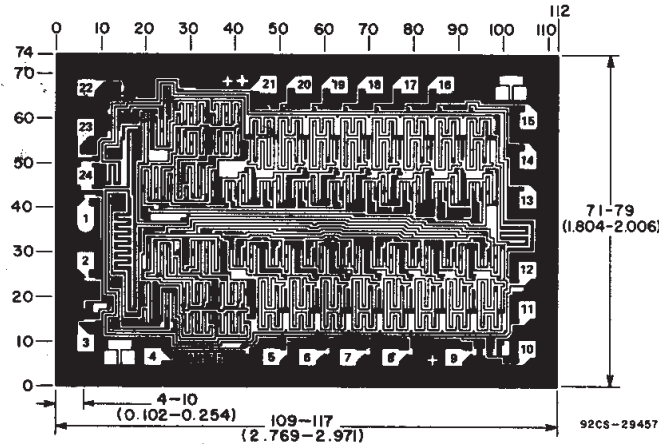

Fig. 14 - Waveforms for setup time and strobe pulse width.



CD4514B
CD4515B

TERMINAL ASSIGNMENT



Dimensions and Pad Layout for CD4515B Chip
(Dimensions and pad layout for the CD4514B are identical)

Dimensions in parentheses are in millimeters and are derived from the basic inch dimensions as indicated. Grid graduations are in mils (10^{-3} inch).

PACKAGING INFORMATION

Orderable Device	Status (1)	Package Type	Package Drawing	Pins	Package Qty	Eco Plan (2)	Lead/Ball Finish (6)	MSL Peak Temp (3)	Op Temp (°C)	Device Marking (4/5)	Samples
7703201JA	ACTIVE	CDIP	J	24	1	TBD	Call TI	N / A for Pkg Type	-55 to 125	7703201JA CD4515BF3A	Samples
CD4514BE	LIFEBUY	PDIP	N	24	15	Pb-Free (RoHS)	CU	N / A for Pkg Type	-55 to 125	CD4514BE	
CD4514BEE4	LIFEBUY	PDIP	N	24	15	Pb-Free (RoHS)	CU	N / A for Pkg Type	-55 to 125	CD4514BE	
CD4514BF	ACTIVE	CDIP	J	24	1	TBD	Call TI	N / A for Pkg Type	-55 to 125	CD4514BF	Samples
CD4514BF3A	ACTIVE	CDIP	J	24	1	TBD	Call TI	N / A for Pkg Type	-55 to 125	CD4514BF3A	Samples
CD4514BM	ACTIVE	SOIC	DW	24	25	Green (RoHS & no Sb/Br)	CU NIPDAU	Level-1-260C-UNLIM	-55 to 125	CD4514BM	Samples
CD4514BM96	ACTIVE	SOIC	DW	24	2000	Green (RoHS & no Sb/Br)	CU NIPDAU CU SN	Level-1-260C-UNLIM	-55 to 125	CD4514BM	Samples
CD4514BM96E4	ACTIVE	SOIC	DW	24	2000	Green (RoHS & no Sb/Br)	CU NIPDAU	Level-1-260C-UNLIM	-55 to 125	CD4514BM	Samples
CD4514BM96G4	ACTIVE	SOIC	DW	24	2000	Green (RoHS & no Sb/Br)	CU NIPDAU	Level-1-260C-UNLIM	-55 to 125	CD4514BM	Samples
CD4514BNSR	OBSOLETE	SO	NS	24		TBD	Call TI	Call TI	-55 to 125		
CD4514BPWR	OBSOLETE	TSSOP	PW	24		TBD	Call TI	Call TI	-55 to 125		
CD4515BE	LIFEBUY	PDIP	N	24	15	Pb-Free (RoHS)	CU	N / A for Pkg Type	-55 to 125	CD4515BE	
CD4515BEE4	LIFEBUY	PDIP	N	24	15	Pb-Free (RoHS)	CU	N / A for Pkg Type	-55 to 125	CD4515BE	
CD4515BF3A	ACTIVE	CDIP	J	24	1	TBD	Call TI	N / A for Pkg Type	-55 to 125	7703201JA CD4515BF3A	Samples
CD4515BM	ACTIVE	SOIC	DW	24	25	Green (RoHS & no Sb/Br)	CU NIPDAU	Level-1-260C-UNLIM	-55 to 125	CD4515BM	Samples
CD4515BM96	ACTIVE	SOIC	DW	24	2000	Green (RoHS & no Sb/Br)	CU NIPDAU	Level-1-260C-UNLIM	-55 to 125	CD4515BM	Samples
CD4515BME4	ACTIVE	SOIC	DW	24	25	Green (RoHS & no Sb/Br)	CU NIPDAU	Level-1-260C-UNLIM	-55 to 125	CD4515BM	Samples

(1) The marketing status values are defined as follows:
ACTIVE: Product device recommended for new designs.

LIFEBUY: TI has announced that the device will be discontinued, and a lifetime-buy period is in effect.

NRND: Not recommended for new designs. Device is in production to support existing customers, but TI does not recommend using this part in a new design.

PREVIEW: Device has been announced but is not in production. Samples may or may not be available.

OBSELETE: TI has discontinued the production of the device.

⁽²⁾ Eco Plan - The planned eco-friendly classification: Pb-Free (RoHS), Pb-Free (RoHS Exempt), or Green (RoHS & no Sb/Br) - please check <http://www.ti.com/productcontent> for the latest availability information and additional product content details.

TBD: The Pb-Free/Green conversion plan has not been defined.

Pb-Free (RoHS): TI's terms "Lead-Free" or "Pb-Free" mean semiconductor products that are compatible with the current RoHS requirements for all 6 substances, including the requirement that lead not exceed 0.1% by weight in homogeneous materials. Where designed to be soldered at high temperatures, TI Pb-Free products are suitable for use in specified lead-free processes.

Pb-Free (RoHS Exempt): This component has a RoHS exemption for either 1) lead-based flip-chip solder bumps used between the die and package, or 2) lead-based die adhesive used between the die and leadframe. The component is otherwise considered Pb-Free (RoHS compatible) as defined above.

Green (RoHS & no Sb/Br): TI defines "Green" to mean Pb-Free (RoHS compatible), and free of Bromine (Br) and Antimony (Sb) based flame retardants (Br or Sb do not exceed 0.1% by weight in homogeneous material)

⁽³⁾ MSL, Peak Temp. - The Moisture Sensitivity Level rating according to the JEDEC industry standard classifications, and peak solder temperature.

⁽⁴⁾ There may be additional marking, which relates to the logo, the lot trace code information, or the environmental category on the device.

⁽⁵⁾ Multiple Device Markings will be inside parentheses. Only one Device Marking contained in parentheses and separated by a "~" will appear on a device. If a line is indented then it is a continuation of the previous line and the two combined represent the entire Device Marking for that device.

⁽⁶⁾ Lead/Ball Finish - Orderable Devices may have multiple material finish options. Finish options are separated by a vertical ruled line. Lead/Ball Finish values may wrap to two lines if the finish value exceeds the maximum column width.

Important Information and Disclaimer: The information provided on this page represents TI's knowledge and belief as of the date that it is provided. TI bases its knowledge and belief on information provided by third parties, and makes no representation or warranty as to the accuracy of such information. Efforts are underway to better integrate information from third parties. TI has taken and continues to take reasonable steps to provide representative and accurate information but may not have conducted destructive testing or chemical analysis on incoming materials and chemicals. TI and TI suppliers consider certain information to be proprietary, and thus CAS numbers and other limited information may not be available for release.

In no event shall TI's liability arising out of such information exceed the total purchase price of the TI part(s) at issue in this document sold by TI to Customer on an annual basis.

OTHER QUALIFIED VERSIONS OF CD4514B, CD4514B-MIL, CD4515B, CD4515B-MIL :

● Catalog: [CD4514B](#), [CD4515B](#)

● Military: [CD4514B-MIL](#), [CD4515B-MIL](#)

NOTE: Qualified Version Definitions:

- Catalog - TI's standard catalog product
- Military - QML certified for Military and Defense Applications

TAPE AND REEL INFORMATION

QUADRANT ASSIGNMENTS FOR PIN 1 ORIENTATION IN TAPE

*All dimensions are nominal

Device	Package Type	Package Drawing	Pins	SPQ	Reel Diameter (mm)	Reel Width W1 (mm)	A0 (mm)	B0 (mm)	K0 (mm)	P1 (mm)	W (mm)	Pin1 Quadrant
CD4514BM96	SOIC	DW	24	2000	330.0	24.4	10.75	15.7	2.7	12.0	24.0	Q1
CD4514BM96	SOIC	DW	24	2000	330.0	24.4	10.75	15.7	2.7	12.0	24.0	Q1
CD4514BM96G4	SOIC	DW	24	2000	330.0	24.4	10.75	15.7	2.7	12.0	24.0	Q1
CD4515BM96	SOIC	DW	24	2000	330.0	24.4	10.75	15.7	2.7	12.0	24.0	Q1

TAPE AND REEL BOX DIMENSIONS



*All dimensions are nominal

Device	Package Type	Package Drawing	Pins	SPQ	Length (mm)	Width (mm)	Height (mm)
CD4514BM96	SOIC	DW	24	2000	364.0	361.0	36.0
CD4514BM96	SOIC	DW	24	2000	367.0	367.0	45.0
CD4514BM96G4	SOIC	DW	24	2000	367.0	367.0	45.0
CD4515BM96	SOIC	DW	24	2000	367.0	367.0	45.0

J (R-GDIP-T**)

CERAMIC DUAL-IN-LINE PACKAGE

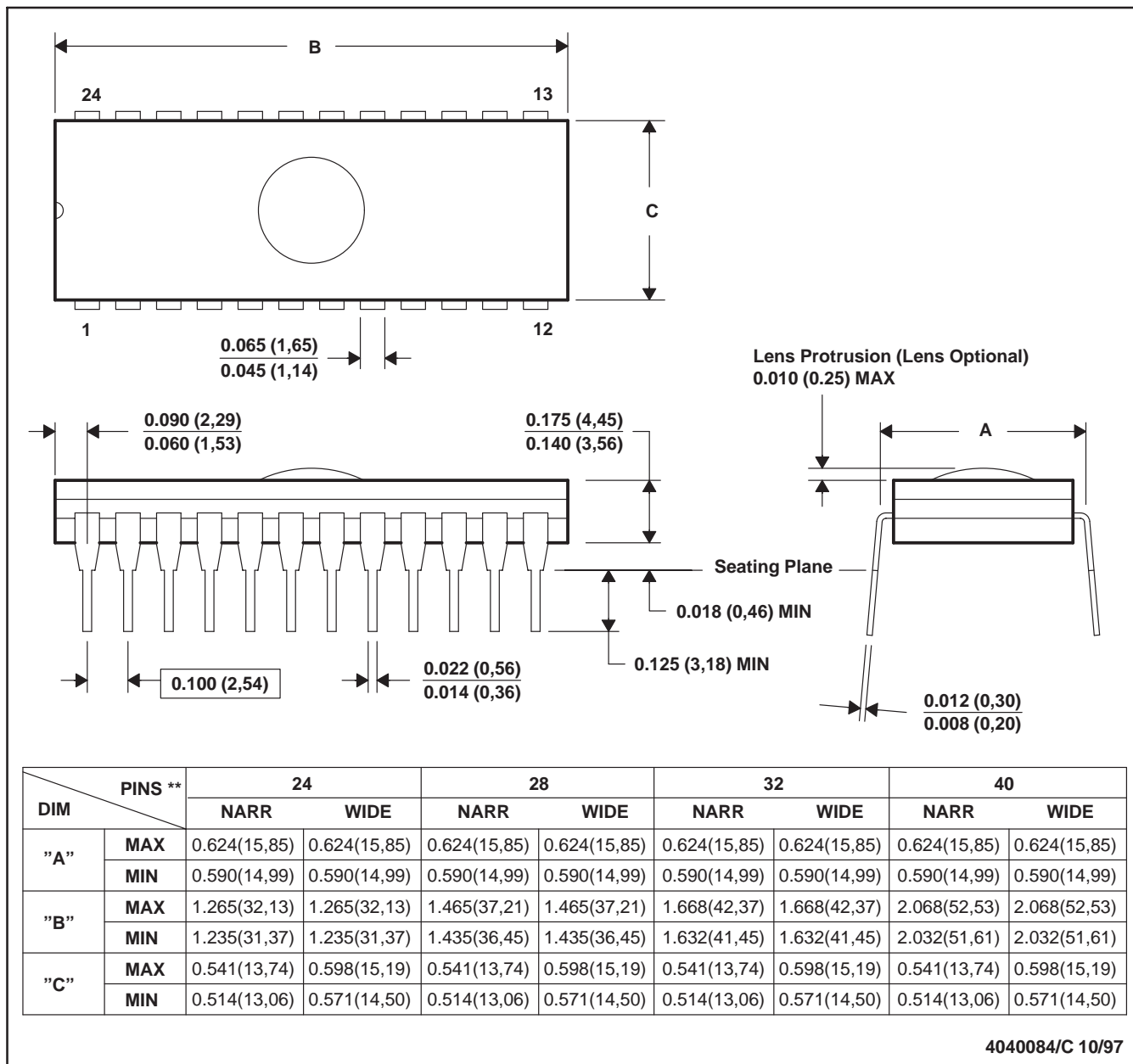
24 PINS SHOWN



- NOTES: A. All linear dimensions are in inches (millimeters).
 B. This drawing is subject to change without notice.
 C. Window (lens) added to this group of packages (24-, 28-, 32-, 40-pin).
 D. This package can be hermetically sealed with a ceramic lid using glass frit.
 E. Index point is provided on cap for terminal identification.

N (R-PDIP-T)**

PLASTIC DUAL-IN-LINE PACKAGE

24 PIN SHOWN



- NOTES: A. All linear dimensions are in inches (millimeters).
 B. This drawing is subject to change without notice.
 C. Falls within JEDEC MS-011
 D. Falls within JEDEC MS-015 (32 pin only)

DW (R-PDSO-G24)

PLASTIC SMALL OUTLINE



- NOTES:
- A. All linear dimensions are in inches (millimeters). Dimensioning and tolerancing per ASME Y14.5M-1994.
 - B. This drawing is subject to change without notice.
 - C. Body dimensions do not include mold flash or protrusion not to exceed 0.006 (0,15).
 - D. Falls within JEDEC MS-013 variation AD.

DW (R-PDSO-G24)

PLASTIC SMALL OUTLINE



4209202-5/F 08/13

- NOTES:
- A. All linear dimensions are in millimeters.
 - B. This drawing is subject to change without notice.
 - C. Refer to IPC7351 for alternate board design.
 - D. Laser cutting apertures with trapezoidal walls and also rounding corners will offer better paste release. Customers should contact their board assembly site for stencil design recommendations. Refer to IPC-7525
 - E. Customers should contact their board fabrication site for solder mask tolerances between and around signal pads.

PW (R-PDSO-G24)

PLASTIC SMALL OUTLINE



4040064-6/G 02/11

- NOTES:
- A. All linear dimensions are in millimeters. Dimensioning and tolerancing per ASME Y14.5M-1994.
 - B. This drawing is subject to change without notice.
 -  C. Body length does not include mold flash, protrusions, or gate burrs. Mold flash, protrusions, or gate burrs shall not exceed 0,15 each side.
 -  D. Body width does not include interlead flash. Interlead flash shall not exceed 0,25 each side.
 - E. Falls within JEDEC MO-153

MECHANICAL DATA

NS (R-PDSO-G**)

PLASTIC SMALL-OUTLINE PACKAGE

14-PINS SHOWN



- NOTES:
- A. All linear dimensions are in millimeters.
 - B. This drawing is subject to change without notice.
 - C. Body dimensions do not include mold flash or protrusion, not to exceed 0,15.

IMPORTANT NOTICE

Texas Instruments Incorporated and its subsidiaries (TI) reserve the right to make corrections, enhancements, improvements and other changes to its semiconductor products and services per JESD46, latest issue, and to discontinue any product or service per JESD48, latest issue. Buyers should obtain the latest relevant information before placing orders and should verify that such information is current and complete. All semiconductor products (also referred to herein as "components") are sold subject to TI's terms and conditions of sale supplied at the time of order acknowledgment.

TI warrants performance of its components to the specifications applicable at the time of sale, in accordance with the warranty in TI's terms and conditions of sale of semiconductor products. Testing and other quality control techniques are used to the extent TI deems necessary to support this warranty. Except where mandated by applicable law, testing of all parameters of each component is not necessarily performed.

TI assumes no liability for applications assistance or the design of Buyers' products. Buyers are responsible for their products and applications using TI components. To minimize the risks associated with Buyers' products and applications, Buyers should provide adequate design and operating safeguards.

TI does not warrant or represent that any license, either express or implied, is granted under any patent right, copyright, mask work right, or other intellectual property right relating to any combination, machine, or process in which TI components or services are used. Information published by TI regarding third-party products or services does not constitute a license to use such products or services or a warranty or endorsement thereof. Use of such information may require a license from a third party under the patents or other intellectual property of the third party, or a license from TI under the patents or other intellectual property of TI.

Reproduction of significant portions of TI information in TI data books or data sheets is permissible only if reproduction is without alteration and is accompanied by all associated warranties, conditions, limitations, and notices. TI is not responsible or liable for such altered documentation. Information of third parties may be subject to additional restrictions.

Resale of TI components or services with statements different from or beyond the parameters stated by TI for that component or service voids all express and any implied warranties for the associated TI component or service and is an unfair and deceptive business practice. TI is not responsible or liable for any such statements.

Buyer acknowledges and agrees that it is solely responsible for compliance with all legal, regulatory and safety-related requirements concerning its products, and any use of TI components in its applications, notwithstanding any applications-related information or support that may be provided by TI. Buyer represents and agrees that it has all the necessary expertise to create and implement safeguards which anticipate dangerous consequences of failures, monitor failures and their consequences, lessen the likelihood of failures that might cause harm and take appropriate remedial actions. Buyer will fully indemnify TI and its representatives against any damages arising out of the use of any TI components in safety-critical applications.

In some cases, TI components may be promoted specifically to facilitate safety-related applications. With such components, TI's goal is to help enable customers to design and create their own end-product solutions that meet applicable functional safety standards and requirements. Nonetheless, such components are subject to these terms.

No TI components are authorized for use in FDA Class III (or similar life-critical medical equipment) unless authorized officers of the parties have executed a special agreement specifically governing such use.

Only those TI components which TI has specifically designated as military grade or "enhanced plastic" are designed and intended for use in military/aerospace applications or environments. Buyer acknowledges and agrees that any military or aerospace use of TI components which have **not** been so designated is solely at the Buyer's risk, and that Buyer is solely responsible for compliance with all legal and regulatory requirements in connection with such use.

TI has specifically designated certain components as meeting ISO/TS16949 requirements, mainly for automotive use. In any case of use of non-designated products, TI will not be responsible for any failure to meet ISO/TS16949.

Products

Audio	www.ti.com/audio
Amplifiers	amplifier.ti.com
Data Converters	dataconverter.ti.com
DLP® Products	www.dlp.com
DSP	dsp.ti.com
Clocks and Timers	www.ti.com/clocks
Interface	interface.ti.com
Logic	logic.ti.com
Power Mgmt	power.ti.com
Microcontrollers	microcontroller.ti.com
RFID	www.ti-rfid.com
OMAP Applications Processors	www.ti.com/omap
Wireless Connectivity	www.ti.com/wirelessconnectivity

Applications

Automotive and Transportation	www.ti.com/automotive
Communications and Telecom	www.ti.com/communications
Computers and Peripherals	www.ti.com/computers
Consumer Electronics	www.ti.com/consumer-apps
Energy and Lighting	www.ti.com/energy
Industrial	www.ti.com/industrial
Medical	www.ti.com/medical
Security	www.ti.com/security
Space, Avionics and Defense	www.ti.com/space-avionics-defense
Video and Imaging	www.ti.com/video

TI E2E Community

e2e.ti.com