



AC1015 • 15 Amp Current Transformer

Low Cost 50/60Hz Current Transformers

Applications

- Sensing Overload Current
- Ground fault detection
- Metering
- Analog to Digital Circuits
- Competitive pricing due to high volume production
- Manufactured in an ISO-9001:2000, TS-16949:2002 and ISO-14001:2004 certified Talema facility
- Fully RoHS compliant

Electrical Specifications @ 20°C ambient

Electrical Specifications	
Primary Current	15A nom., 60 A max.
Turns Ratio	1000:1 nominal
Volt per Amp Ratio at 15A for 100 ohm load	0.100 V/A
Volt per Amp Ratio at 1.5A for 100 ohm load	0.097 V/A
DC Resistance at 20°C	41.8 ohms
Dielectric Withstanding Voltage (Hi-pot)	4KVrms
Mechanical Specifications	
Case	Polycarbonate
Encapsulant	Epoxy
Flammibility	Conforms to UL94-VO
Terminals	Pins Ø 0.80mm
Marking	TALEMA Date Code (W/Y) AC1015, Dot at start pin
Approximate Weight	16.3 grams
Tolerance	±0.2mm



Environmental Specifications	
Storage Temperature	-55° to +130°C
Insulation Resistance	100 megohms min.

Output Volts vs Input Current
For various ohmic loads

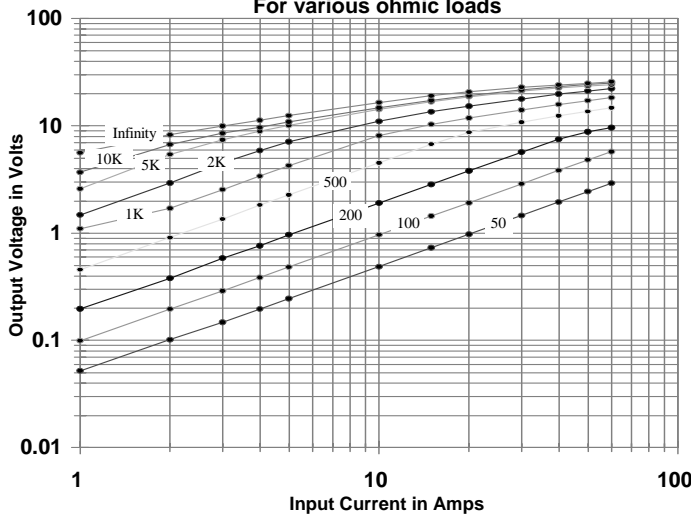

%RE vs RL at Rated primary current
(AC1015)

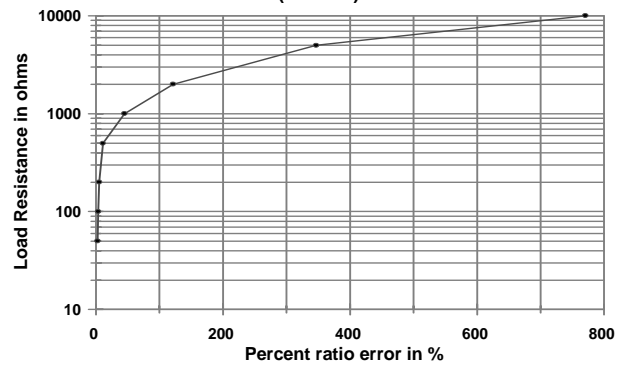

Typical Excitation Curve
(AC1005-AC1020)

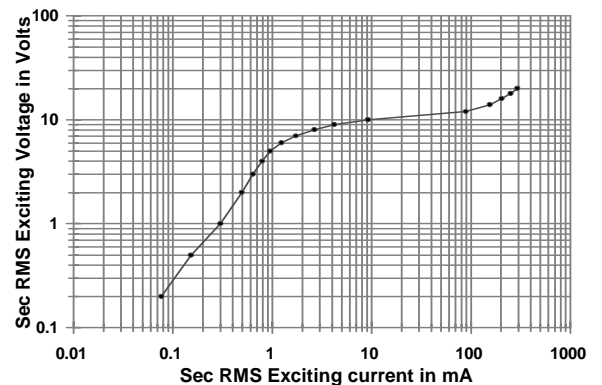

Dimensions

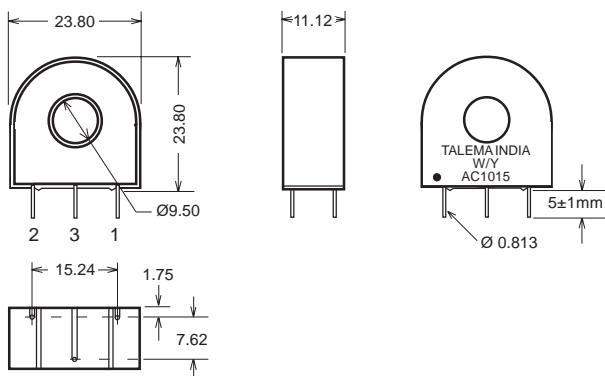

Notes:

- 1) Unless requested, the terminating resistor and the one-turn primary are not supplied
- 2) Pin 3: Normally for mechanical support only but will be used on center tapped designs

