



# Specification

Wah Wang Data Sheet

For 5050 Three Chips Neutral White Color Top LED

**Part No:** WW-WTD50TC-T1



Address : Unit 01, 19<sup>th</sup> Floor, Nanyang Plaza,  
No.57 Hung To Road, Kwun Tong,  
Kowloon, Hong Kong  
Tel : 852-2512 9939 (10 line)  
Fax : 852-2344 2398  
Web Site : [www.wahwang.com](http://www.wahwang.com)

S.D.N. or D.N. No. : \_\_\_\_\_

Customer Name : \_\_\_\_\_

Sample Approval Signature : \_\_\_\_\_

Date : \_\_\_\_\_



## Technical Datasheet

5050 is thermal management characteristic is better than other LED Solutions. By package SMD design and good thermal emission material.



According to these advantages, it enables to apply various lighting applications and design solution, automotive lighting, and large size LCD backlight etc.

## Applications:

## Features

- PLCC LED dimensions: 5.0(L) x 5.0(W) x 1.6(H) mm
  - High intensity
  - Extremely wide view angle
  - Anti-electrostatic tape package
  - Reliable and stable
- Backlight for LCD Switch and Display
  - Decorative Lighting
  - General Lighting
  - Automotive Interior Lighting
  - General Use

## Package Dimension

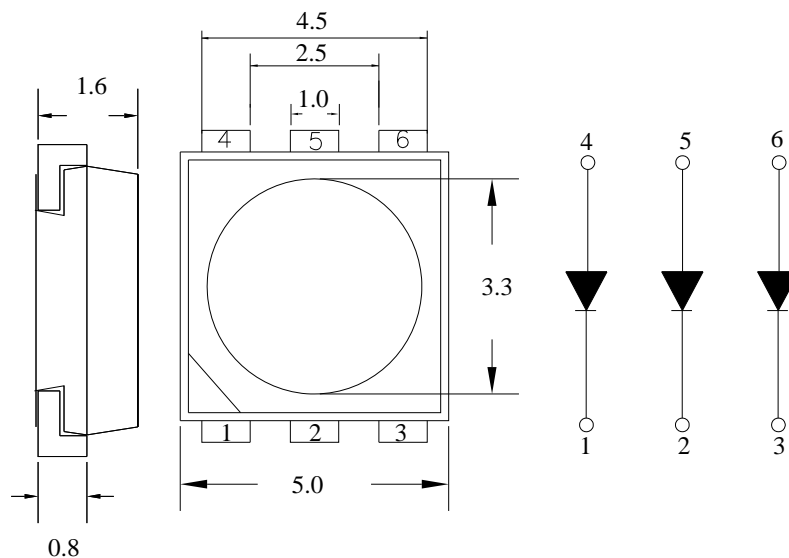

### Notes:

1. All dimension units are in millimeters
2. All dimension Tolerance is  $\pm 0.25\text{mm}$  unless otherwise noted.

**Absolute Maximum Ratings at Ta=25°C**

Parameter	Symbol	Value	Unit
Power dissipation	Pd	200	mW
Continuous Forward Current	I <sub>F</sub>	60	mA
Peak Forward Current (1/10 Duty Cycle, 0.1ms Pulse Width)	I <sub>FP</sub>	50	mA
Reverse Voltage	V <sub>R</sub>	5	V
Electrostatic Discharge (HBM)	ESD	1000	V
Operating Temperature Range	Topr	-25 to +85	°C
Storage Temperature Range	Tstg	-40 to +100	°C
Lead Soldering Temperature	Tsol	260( for 5 sec)	°C

**Electrical Optical Characteristics at Ta=25°C**

Parameter	Symbol	Min.	Typ.	Max.	Unit	Test Condition
Luminous Intensity	I <sub>v</sub>	4800	---	7000	mcd	I <sub>F</sub> = 60mA (Note 8)
Ref. Luminous Flux	Φ <sub>v</sub>	18	20	---	Lm	I <sub>F</sub> = 60mA
Viewing Angle	2θ <sub>1/2</sub>	---	120	---	Deg	I <sub>F</sub> = 60mA
Forward Voltage	V <sub>F</sub>	2.8	---	3.4	V	I <sub>F</sub> = 60mA
Reverse Current	I <sub>R</sub>	---	---	30	μA	V <sub>R</sub> = 5V

**Notes:**

1. WW maintains a tolerance of ±10% on flux and power measurements.
2. λd ±1nm; X,Y Tolerance each Bin limit is ± 0.01
3. A tolerance of ±0.1V on forward voltage measurements
4. View Angle maintains a tolerance of ±20°
5. Specifications are subject to change without notice.
6. These products are sensitive to static electricity; high standard of care must be fully taken when handling them. Particularly if an over-voltage that exceeds the Absolute maximum Rating of these products were applied, the overflow energy will cause damage to and possibly result in destruction of these products. Buyer shall take absolute secure countermeasures against static electricity and surge when handling these products.
7. Luminous intensity is measured with a light sensor and filter combination that approximates the CIE eye-response curve.θ<sub>1/2</sub> is the off-axis angle at which the luminous intensity is half the axial luminous intensity.
8. It uses many parameters that correspond to the CIE 1931 2° X,Y, and Z are CIE1931 2° values of Red, Green and Blue content of the measurement.



## Typical Characteristics

### Typical Electrical/Optical Characteristic Curves

Fig.1 IF-VF(Ta=25°C)

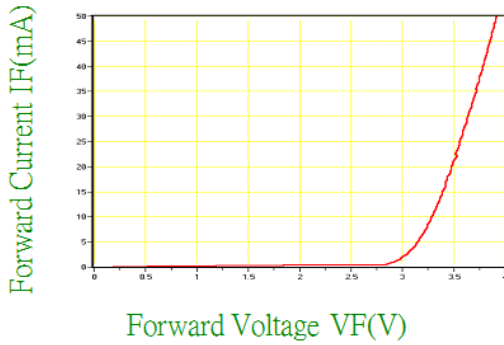

Fig.2 Relative Luminous Intensity-IF (Ta=25°C)

(25°C Ambient Temperature Unless Otherwise Noted)

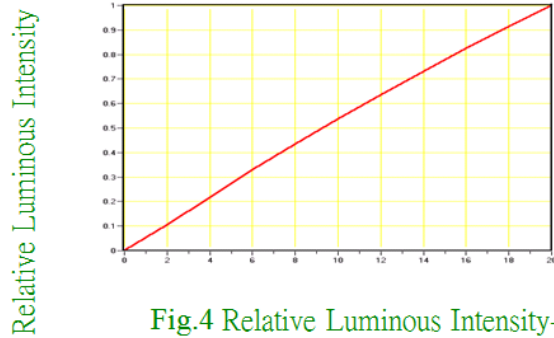

Fig.3 Wavelength Characteristics (Ta=25°C)

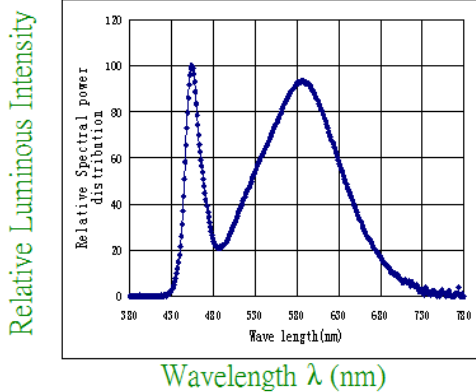
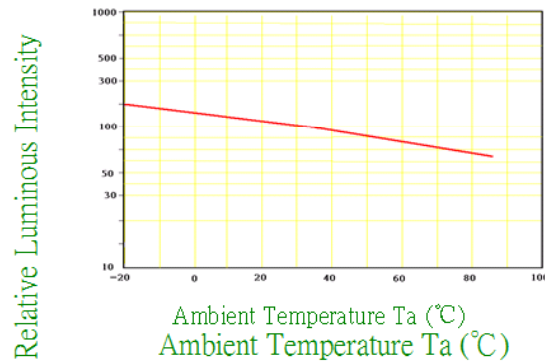

Fig.4 Relative Luminous Intensity-Ta

Fig.4 Relative Luminous Intensity-Ta



Wavelength λ (nm)

Fig.5 IF-Ta

Fig.5 IF-Ta

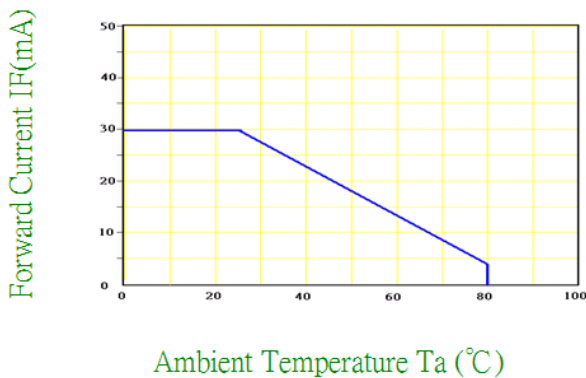

Directive Characteristics (Ta=25°C)

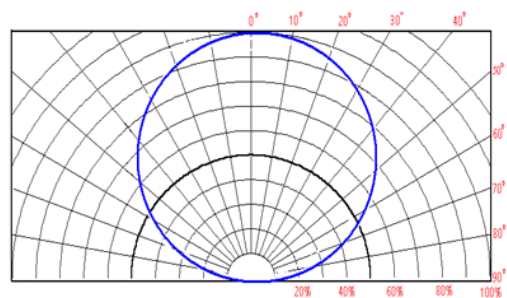



## Chromaticity Coordinates Specifications for Bin Grading:

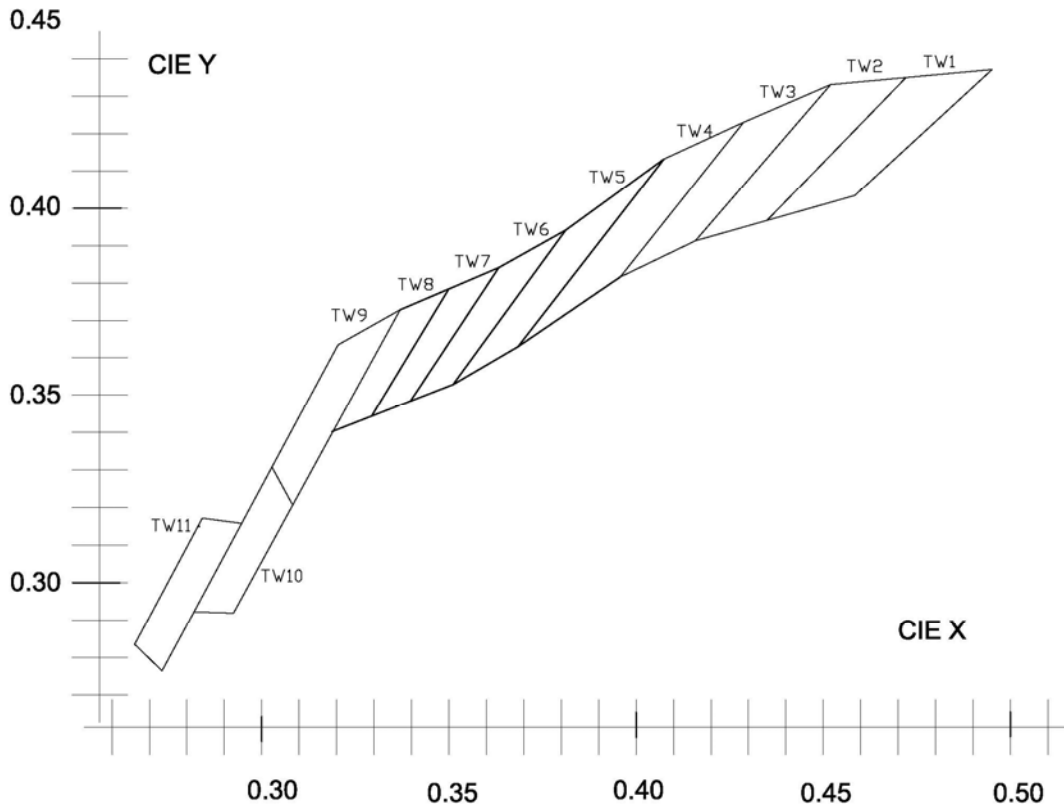

Color Ranks		Warm White				White					
TW1	X	0.4395	0.4585	0.4952	0.4721	TW7	X	0.3276	0.3361	0.3581	0.3476
	Y	0.3914	0.3935	0.4272	0.4251		Y	0.3317	0.3329	0.3661	0.3645
TW2	X	0.4231	0.4395	0.4721	0.452	TW8	X	0.319	0.3276	0.3476	0.337
	Y	0.3896	0.3914	0.4251	0.4231		Y	0.3305	0.3317	0.3645	0.363
TW3	X	0.4022	0.4159	0.4447	0.4287	TW9	X	0.3083	0.3029	0.3245	0.3205
	Y	0.3798	0.3814	0.4147	0.4131		Y	0.3111	0.3209	0.3408	0.3541
TW4	X	0.3815	0.3958	0.422	0.4072	TW10	X	0.2865	0.2924	0.3029	0.3083
	Y	0.3695	0.3717	0.4048	0.4029		Y	0.2903	0.2819	0.3209	0.3111
TW5	X	0.3573	0.3684	0.3944	0.3812	TW11	X	0.2661	0.2734	0.2907	0.2841
	Y	0.3513	0.353	0.3861	0.3842		Y	0.2737	0.2664	0.2978	0.3072
TW6	X	0.3417	0.3511	0.3752	0.3635						
	Y	0.3415	0.3429	0.3759	0.3742						

**Notes:**

Color	Group	Customer Ranks	Factory code	TC(K)
Warm White	1	TW1	TCn-q	2500-2800
	2	TW2	TDn-q	2700-3000
	3	TW3	Tem-p	3000-3500
	4	TW4	TFI-o	3300-3900
Neutral White	5	TW5	TGj-m	3800-4400
	6	TW6	Thi-l	4200-4900
	7	TW7	Tih-k	4600-5600
Cool White	8	TW8	TJh-k	5000-6000
	9	TW9	TKd-g	6000-7000
	10	TW10	TK9-c	7000-9000
	11	TW11	TL6-9	9000-12000

\*Customer can choose any group

\*Tolerance of Color Temperatureis upper 9000K  $\pm$ 500K / 9000K-5000K  $\pm$ 100K / below 5000K  $\pm$ 50K

\*X and Y are CIE1931; Color Coordinates Measurement allowance is  $\pm$ 0.01

**Reliability:**

## 1) Test Items and Results

No.	Test Item	Standard Test Method	Test Conditions	Note	Number of Damaged
1	Steady State Operating Life	JEITA ED-4701 100 103	If=60mA Ta=25°C	1000hrs	0/22
2	Low Temperature Storage	JEITA ED-4701 200 202	Ta=-40°C	1000hrs	0/22
3	High Temperature Storage	JEITA ED-4701 200 201	Ta=100°C	1000hrs	0/22
4	Temperature Humidity Storage	JEITA ED-4701 100 103	Ta=60°C RH=90%	1000hrs	0/22
5	Thermal Shock	JEITA ED-4701 300 307	0°C ~ +100°C 5min~ 15sec ~ 5min	10 cycles	0/22
6	Temperature Cycle	JEITA ED-4701 100 105	H: +100°C 30min. ∫ : +25°C 5min. L: -40°C 30min	100 cycles	0/22
7	Solder Heat	JEITA ED-4701 300 301	Tsld=260°C, 10sec (Max.)	2 times	0/22

## Failed Conditions

Item	Symbol	Test Condition	Min	Max
Forward Voltage	Vf	If=60mA	--	*U.S.L×1.1
Reverse Current	Ir	Vr=5V	--	*U.S.L×2.0
Luminous Intensity	Iv	If=60mA	**L.S.L×0.7	--

\*U.S.L.:Upper Standard Level

\*\* L.S.L.:Lower Standard Level

**Bin Range**

Luminous intensity

Bin Code	Min. (mcd)	Max. (mcd)
17	4000	4800
18	4800	5800
19	5800	7000
20	7000	10000



## Dimensions for Tape

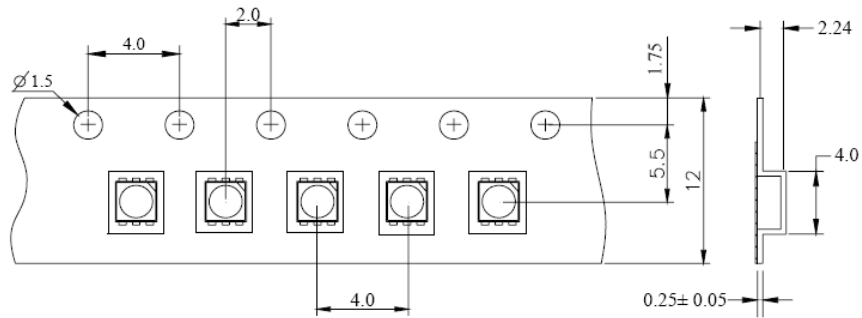

## Dimensions for Reel

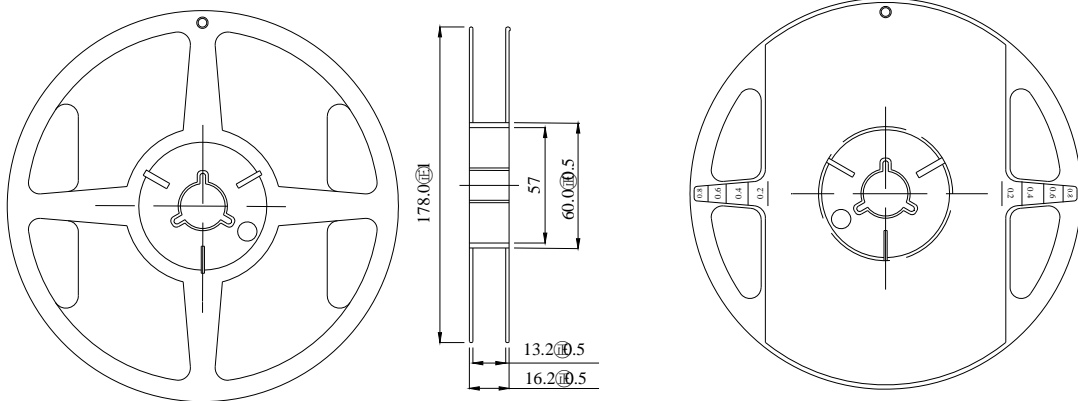

### Notes:

1. All dimensions are in mm, tolerance is  $\pm 2.0$ mm unless otherwise noted.

## Moisture, anti-static vacuum sealed packages

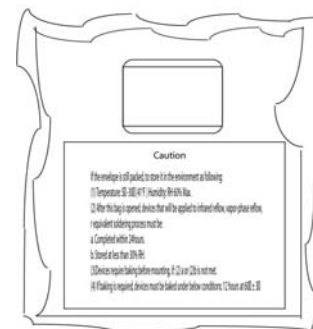
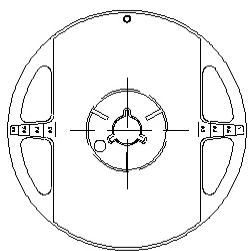

### Notes:

All dimensions are in mm, tolerance is  $\pm 2.0$ mm unless otherwise noted.



## PRECAUTION IN USE

### Storage

Recommended storage environment

Temperature: 5°C ~ 30°C (41°F ~ 86°F)

Humidity: 60% RH Max.

Recommend the use of drying cabinet storage

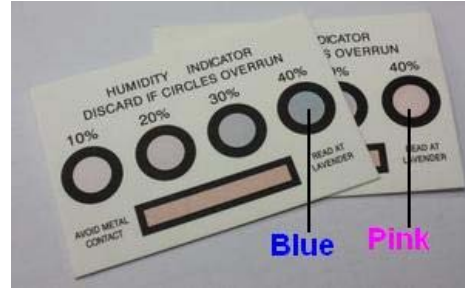

### Use

Please check the Humidity indicator card after opening of sealed vapor/ESD (Picture 1.) If the 40% circle color is still blue, the product could normal use. Otherwise, 40% circle color is pink; please follow below Baking treatment before normal use. Baking treatment : Open-static bag, the product and reel dial out from the Static bag, and then 75±5°C for 8 hours baking treatment.

Remaining product be sealed in time, recommend storage in dry cabinet storage. It must be baking treatment when using the remaining product.

### Handling Precautions

Compare to epoxy encapsulant that is hard and brittle, silicone is softer and flexible. Although its characteristic significantly reduces thermal stress, it is more susceptible to damage by external mechanical force . As a result,

1. Handle the component along the side surface by using forceps or appropriate tools.
2. Do not directly touch or handle the silicone lens surface. It may damage the internal circuitry
3. Do not stack together assembled PCBs containing LEDs. Impact may scratch the silicone lens or damage

### Soldering

#### A. Reflow Process

Reflow Soldering		
	Lead Solder	Lead – free Solder
Pre-heat	120~150°C	180~200°C
Pre-heat time	120sec. Max.	120sec. Max.
Peak temperature	240°C Max.	260°C Max.
Soldering time	10sec. Max.	0sec. Max.
Condition	refer to Temperature-profile 1	refer to Temperature-profile 2

After reflow soldering rapid cooling should be avoided.

[Temperature-profile (Surface of circuit board)] Use the conditions shown to the under figure.

< 1 : Lead Solder >

< 2 : Lead-free Solder >

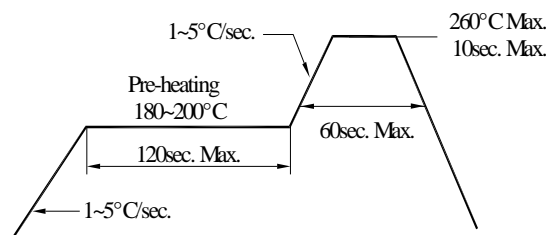
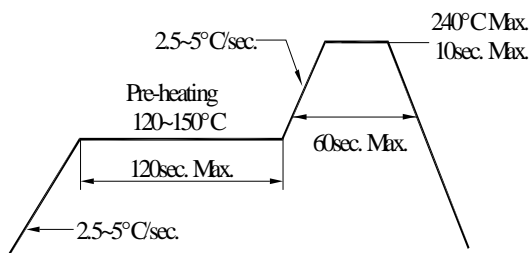

#### B. Manual Soldering Process

Hand Soldering	
Temperature	350°C Max.
Soldering time	3sec. Max. (one time only)

- a. For prototype builds or small series production runs it is possible to place and solder the LED by hand.
- b. Dispense thermal conductive glue or grease on the substrates and follow its curing specifications. Gently press LED housing to closely connect LED and substrate.
- c. It is recommended to hand solder the leads with a solder tip temperature of 280°C for less than 3 second, at a time with a soldering iron of less than 25W. Solder at intervals of two seconds or more.
- d. Take caution and be aware that damaged products are often a result of improper hand soldering technique.





## Rework

1. Customer must finish rework within 5 sec under 260°C
2. The head of iron cannot touch the resin
3. Twin-head type is preferred.

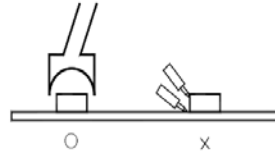

## Cleaning :

The conditions of cleaning after soldering:

An alcohol-based solvent such as Isopropyl Alcohol(IPA) is recommended.

Temperature Time:<50°C\*30sec,or <30°C\*3min

Ultra sonic cleaning:<15W/bath; Bath volume:1liter max.

Curing:100 max,<3min

## Cautions of Pick and Place:

It should be avoided to load stress on the resin during high temperature.

Avoid rubbing or scraping the resin by any object.

Electric-static may cause damage to the component. Please confirm that the equipment is grounding well. Using an ionizer fan is recommended.

## Cautions of Design and Applications:

It should be done to connect with a current-limiting serial resistor. Avoid to drive reverse voltage over the specifications on LED when ON/OFF. Any application should refer to the specifications of absolute maximum ratings.

The dimensions of the recommended soldering pattern may not meet every users. Please confirm and study before designing the soldering pattern in order to obtain the best performance of soldering.

Do not contact with any component on the assembly board.

## Static Electricity:

These products are so sensitive to static electricity charge so that all equipment and machinery must be properly grounded and it is recommended to use a wristband or anti-electrostatic glove when handling the SMD LED.

Particularly if any over-current and over-voltage which exceed the Absolute Maximum Ratings of LED applied, the more energy may cause damage or possibly result in electrical destruction of the Products.

A protection design should be installed in the LED driving circuit, which does not exceed the max. rating for surge current during on/off switching.

A tip if soldering iron is requested to be grounded .An ionizer should be installed when risk of static generation is high.

If the countermeasures mentioned above are implemented, LED can work well.

Users are required to check those countermeasures when problems occur by static electricity charge

## Other:

Damaged SMD LED will show unusual characteristics such as leak current remarkably low current. Increase, turn-on voltage becomes lower and the SMD LED get unlighted at low current.

In automatic mounting of the SMD LEDs on printed circuit boards, any bending and pulling forces or shock against the SMD LEDs shall be kept min. to prevent them from expanding or electrical failures and mechanical damages of the devices.

## Illustration & Application:

The SMD LED taping is much smaller than leaded components, thus enable smaller size, applications, etc. higher packing density, reduced storage space and finally smaller equipment board to be obtained. Besides, lightweight makes them ideal for miniature

The products described in this brochure are intended only for standard applications or general electronic equipment such as :

1. Telecommunication: indicator and backlight in telephone and fax.
2. Automotive: backlight in dashboard and switch.
3. LCD: Flat backlight for LCD, switch and symbol.

## Notes for designing:

Care must be taken to provide the current limiting resistor in the circuit so as to drive the Wah Wang LEDs within the rated figures. Also, caution should be taken not to overload Wah Wang LEDs with instantaneous voltage at the turning ON and OFF of the circuit.

When using the pulse drive care must be taken to keep the average current within the rated figures. Also, the circuit should be designed so as be subjected to reverse voltage when turning off the Wah Wang LEDs.