

D-SUB coupling - VS-25-KU-ST/ST - 1689682

Please be informed that the data shown in this PDF Document is generated from our Online Catalog. Please find the complete data in the user's documentation. Our General Terms of Use for Downloads are valid (<http://phoenixcontact.com/download>)

D-SUB coupling, shell size 3, pin, gender changer, shielded, connection direction straight, IP67 degree of protection



Key Commercial Data

Packing unit	5 pc
Minimum order quantity	5 pc
GTIN	 4 017918 915506
Weight per Piece (excluding packing)	30.49 g
Custom tariff number	85366990
Country of origin	Germany
Note	Made to Order (non-returnable)

Technical data

General data

Number of positions	25
Signal type/category	Universal
Overvoltage category	III
Degree of pollution	2

Standards and Regulations

Flammability rating according to UL 94	V0
--	----

Classifications

eCl@ss

eCl@ss 4.0	27140816
eCl@ss 4.1	27260701
eCl@ss 5.0	27260701
eCl@ss 5.1	27260701

D-SUB coupling - VS-25-KU-ST/ST - 1689682

Classifications

eCl@ss

eCl@ss 6.0	27261203
eCl@ss 7.0	27440202
eCl@ss 8.0	27440213

ETIM

ETIM 2.0	EC000437
ETIM 3.0	EC000437
ETIM 4.0	EC000437
ETIM 5.0	EC001136

UNSPSC

UNSPSC 6.01	31261501
UNSPSC 7.0901	31261501
UNSPSC 11	31261501
UNSPSC 12.01	31261501
UNSPSC 13.2	31261501

Approvals

Approvals

Approvals

EAC

Ex Approvals

Approvals submitted

Approval details

EAC

Accessories

Accessories

Protective cover

D-SUB coupling - VS-25-KU-ST/ST - 1689682

Accessories

D-SUB protective cover - VS-25-SD - 1652211



D-SUB protective cover, shell size 3, IP54 degree of protection, for panel mounting frame and sleeve housing VS-25-...

Drawings

Dimensional drawing

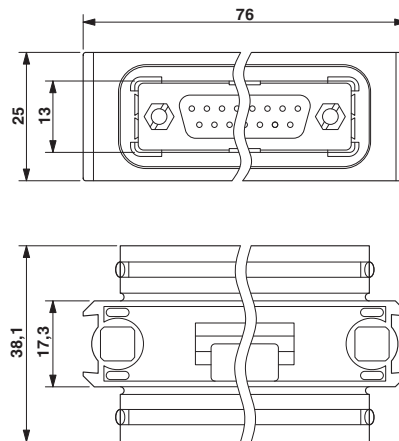

D-SUB coupling