

UF133(72)APA Series

(Centrifugal Fan)

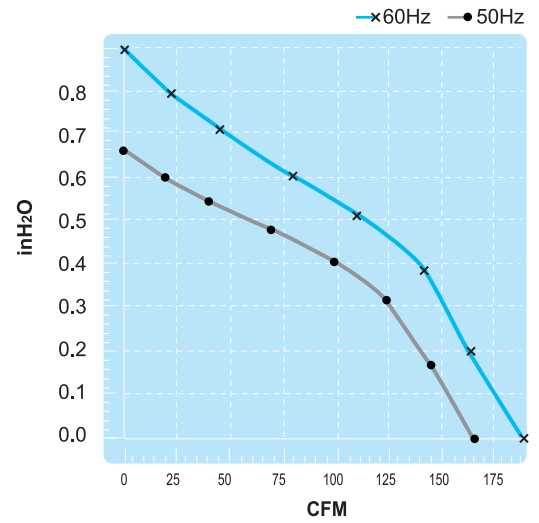

Thermal Protection

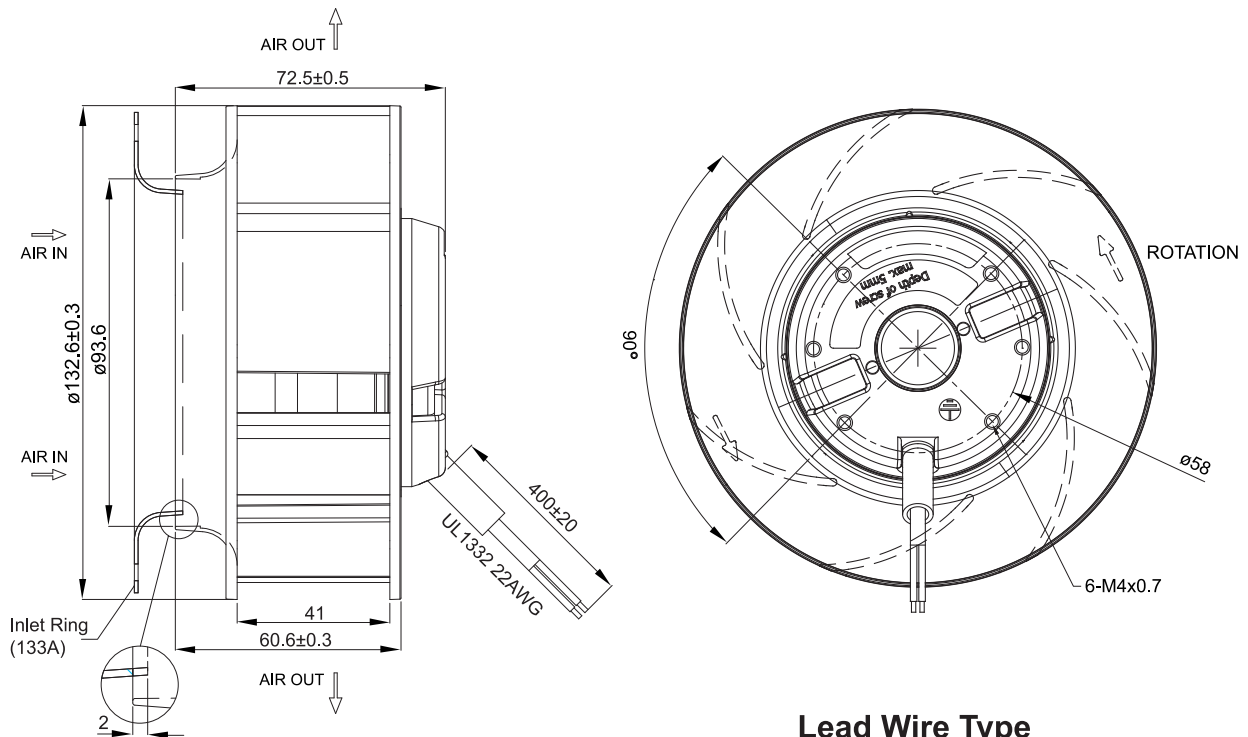

Lead Wire Type



Spec.	Rated Voltage	Frequency	Input Power	Rated Current	Locked Current	Speed	Maximum Air Flow	Maximum Air Flow	Maximum Pressure	Maximum Pressure	Capacitor	Noise	Weight
Model	V	Hz	W	A	A	RPM	m ³ /min.	CFM	mmH ₂ O	InchH ₂ O	uF/VDB	dB	kg
UF133(72)APA 11H1S2A	115V	50	38	0.50	0.83	2780	4.66	165	16.6	0.65	---	50	0.9
		60	37	0.43	0.72	3200	5.33	188	22.4	0.88	---	60	
UF133(72)APA 23H1S2A	230V	50	36	0.24	0.39	2780	4.66	165	16.6	0.65	---	50	0.9
		60	35	0.21	0.34	3200	5.33	188	22.4	0.88	---	60	