

SN75374 QUADRUPLE MOSFET DRIVER

SLRS028A – SEPTEMBER 1988 – REVISED NOVEMBER 2004

- Quadruple Circuits Capable of Driving High-Capacitance Loads at High Speeds
- Output Supply Voltage Range From 5 V to 24 V
- Low Standby Power Dissipation
- V_{CC3} Supply Maximizes Output Source Voltage

description/ordering information

The SN75374 is a quadruple NAND interface circuit designed to drive power MOSFETs from TTL inputs. It provides the high current and voltage necessary to drive large capacitive loads at high speeds.

The outputs can be switched very close to the V_{CC2} supply rail when V_{CC3} is about 3 V higher than V_{CC2} . V_{CC3} also can be tied directly to V_{CC2} when the source voltage requirements are lower.

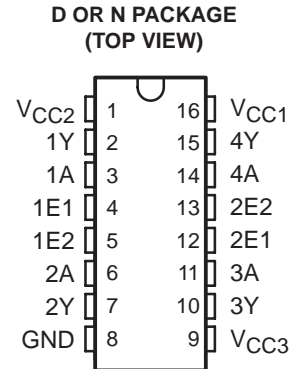

ORDERING INFORMATION

T_A	PACKAGE†		ORDERABLE PART NUMBER	TOP-SIDE MARKING
0°C to 70°C	PDIP (N)	Tube of 25	SN75374N	SN75374N
	SOIC (D)	Tube of 40	SN75374D	SN75374
		Reel of 2500	SN75374DR	

† Package drawings, standard packing quantities, thermal data, symbolization, and PCB design guidelines are available at www.ti.com/sc/package.

logic diagram (positive logic)

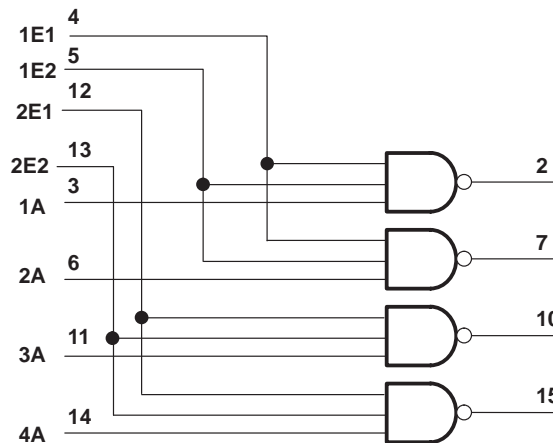

Please be aware that an important notice concerning availability, standard warranty, and use in critical applications of Texas Instruments semiconductor products and disclaimers thereto appears at the end of this data sheet.

PRODUCTION DATA information is current as of publication date. Products conform to specifications per the terms of Texas Instruments standard warranty. Production processing does not necessarily include testing of all parameters.

 **TEXAS
INSTRUMENTS**

POST OFFICE BOX 655303 • DALLAS, TEXAS 75265

Copyright © 2004, Texas Instruments Incorporated

SN75374 QUADRUPLE MOSFET DRIVER

SLRS028A – SEPTEMBER 1988 – REVISED NOVEMBER 2004

schematic (each driver)

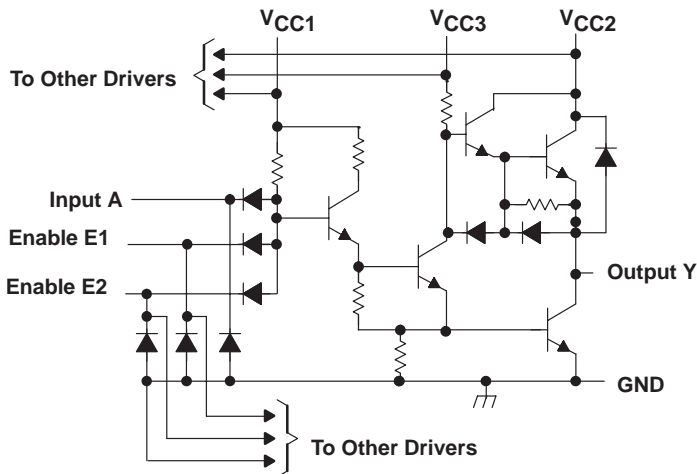

absolute maximum ratings over operating free-air temperature range (unless otherwise noted)[†]

Supply voltage range (see Note 1):	V_{CC1}	-0.5 V to 7 V
	V_{CC2}	-0.5 V to 25 V
	V_{CC3}	-0.5 V to 30 V
Input voltage, V_I		5.5 V
Peak output current, I_O ($t_W < 10$ ms, duty cycle < 50%)		500 mA
Package thermal impedance, θ_{JA} (see Notes 2 and 3):	D package	73°C/W
	N package	67°C/W
Operating virtual junction temperature, T_J		150°C
Storage temperature range, T_{stg}		-65°C to 150°C

[†] Stresses beyond those listed under “absolute maximum ratings” may cause permanent damage to the device. These are stress ratings only, and functional operation of the device at these or any other conditions beyond those indicated under “recommended operating conditions” is not implied. Exposure to absolute-maximum-rated conditions for extended periods may affect device reliability.

- NOTES:
1. Voltage values are with respect to network ground terminal.
 2. Maximum power dissipation is a function of $T_J(\text{max})$, θ_{JA} , and T_A . The maximum allowable power dissipation at any allowable ambient temperature is $P_D = (T_J(\text{max}) - T_A) / \theta_{JA}$. Operating at the absolute maximum T_J of 150°C can affect reliability.
 3. The package thermal impedance is calculated in accordance with JESD 51-7.

recommended operating conditions

		MIN	NOM	MAX	UNIT
V_{CC1}	Supply voltage	4.75	5	5.25	V
V_{CC2}	Supply voltage	4.75	20	24	V
V_{CC3}	Supply voltage	V_{CC2}	24	28	V
$V_{CC3} - V_{CC2}$	Voltage difference between supply voltages	0	4	10	V
V_{IH}	High-level input voltage	2			V
V_{IL}	Low-level input voltage			0.8	V
I_{OH}	High-level output current			-10	mA
I_{OL}	Low-level output current			40	mA
T_A	Operating free-air temperature	0		70	°C



SN75374 QUADRUPLE MOSFET DRIVER

SLRS028A – SEPTEMBER 1988 – REVISED NOVEMBER 2004

electrical characteristics over recommended ranges of V_{CC1} , V_{CC2} , V_{CC3} , and operating free-air temperature (unless otherwise noted)

PARAMETER		TEST CONDITIONS	MIN	TYP†	MAX	UNIT	
V_{IK}	Input clamp voltage	$I_I = -12 \text{ mA}$			-1.5	V	
V_{OH}	High-level output voltage	$V_{CC3} = V_{CC2} + 3 \text{ V}$, $V_{IL} = 0.8 \text{ V}$, $I_{OH} = -100 \mu\text{A}$	$V_{CC2} - 0.3$	$V_{CC2} - 0.1$		V	
		$V_{CC3} = V_{CC2} + 3 \text{ V}$, $V_{IL} = 0.8 \text{ V}$, $I_{OH} = -10 \text{ mA}$	$V_{CC2} - 1.3$	$V_{CC2} - 0.9$			
		$V_{CC3} = V_{CC2}$, $V_{IL} = 0.8 \text{ V}$, $I_{OH} = -50 \mu\text{A}$	$V_{CC2} - 1$	$V_{CC2} - 0.7$			
		$V_{CC3} = V_{CC2}$, $V_{IL} = 0.8 \text{ V}$, $I_{OH} = -10 \text{ mA}$	$V_{CC2} - 2.5$	$V_{CC2} - 1.8$			
V_{OL}	Low-level output voltage	$V_{IH} = 2 \text{ V}$, $I_{OL} = 10 \text{ mA}$		0.15	0.3	V	
		$V_{CC2} = 15 \text{ V to } 28 \text{ V}$, $V_{IH} = 2 \text{ V}$, $I_{OL} = 40 \text{ mA}$		0.25	0.5		
V_F	Output clamp-diode forward voltage	$V_I = 0$, $I_F = 20 \text{ mA}$			1.5	V	
I_I	Input current at maximum input voltage	$V_I = 5.5 \text{ V}$			1	mA	
I_{IH}	High-level input current	Any A Any E $V_I = 2.4 \text{ V}$			40	μA	
					80		
I_{IL}	Low-level input current	Any A Any E $V_I = 0.4 \text{ V}$		-1	-1.6	mA	
				-2	-3.2		
$I_{CC1(H)}$	Supply current from V_{CC1} , all outputs high			4	8	mA	
$I_{CC2(H)}$	Supply current from V_{CC2} , all outputs high	$V_{CC1} = 5.25 \text{ V}$, All inputs at 0 V,	$V_{CC2} = 24 \text{ V}$, No load	$V_{CC3} = 28 \text{ V}$	-2.2		0.25
$I_{CC3(H)}$	Supply current from V_{CC3} , all outputs high				2.2		3.5
$I_{CC1(L)}$	Supply current from V_{CC1} , all outputs low			31	47	mA	
$I_{CC2(L)}$	Supply current from V_{CC2} , all outputs low	$V_{CC1} = 5.25 \text{ V}$, All inputs at 5 V,	$V_{CC2} = 24 \text{ V}$, No load	$V_{CC3} = 28 \text{ V}$			2
$I_{CC3(L)}$	Supply current from V_{CC3} , all outputs low				16		27
$I_{CC2(H)}$	Supply current from V_{CC2} , all outputs high	$V_{CC1} = 5.25 \text{ V}$, All inputs at 0 V,	$V_{CC2} = 24 \text{ V}$, No load	$V_{CC3} = 24 \text{ V}$		0.25	mA
$I_{CC3(H)}$	Supply current from V_{CC3} , all outputs high					0.5	
$I_{CC2(S)}$	Supply current from V_{CC2} , standby condition	$V_{CC1} = 0$, All inputs at 0 V,	$V_{CC2} = 24 \text{ V}$, No load	$V_{CC3} = 24 \text{ V}$		0.25	mA
$I_{CC3(S)}$	Supply current from V_{CC3} , standby condition					0.5	

† All typical values are at $V_{CC1} = 5 \text{ V}$, $V_{CC2} = 20 \text{ V}$, $V_{CC3} = 24 \text{ V}$, and $T_A = 25^\circ\text{C}$, except for V_{OH} for which V_{CC2} and V_{CC3} are as stated under test conditions.

switching characteristics, $V_{CC1} = 5 \text{ V}$, $V_{CC2} = 20 \text{ V}$, $V_{CC3} = 24 \text{ V}$, $T_A = 25^\circ\text{C}$

PARAMETER		TEST CONDITIONS	MIN	TYP	MAX	UNIT	
t_{DLH}	Delay time, low- to high-level output	$C_L = 200 \text{ pF}$, $R_D = 24 \Omega$, See Figure 1		20	30	ns	
t_{DHL}	Delay time, high- to low-level output			10	20	ns	
t_{PLH}	Propagation delay time, low- to high-level output			10	40	60	ns
t_{PHL}	Propagation delay time, high- to low-level output			10	30	50	ns
t_{TLH}	Transition time, low- to high-level output				20	30	ns
t_{THL}	Transition time, high- to low-level output				20	30	ns



SN75374 QUADRUPLE MOSFET DRIVER

SLRS028A – SEPTEMBER 1988 – REVISED NOVEMBER 2004

PARAMETER MEASUREMENT INFORMATION

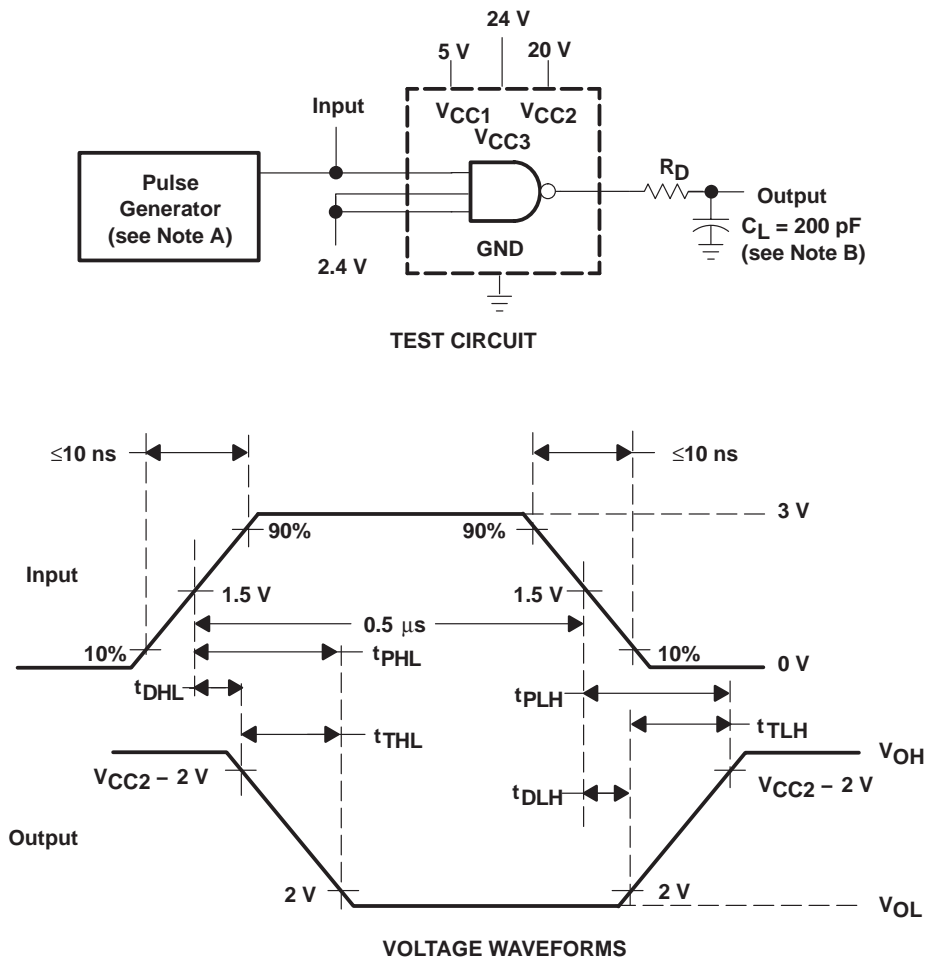

NOTES: A. The pulse generator has the following characteristics: PRR = 1 MHz, $Z_O \approx 50 \Omega$.
B. C_L includes probe and jig capacitance.

Figure 1. Test Circuit and Voltage Waveforms, Each Driver

TYPICAL CHARACTERISTICS

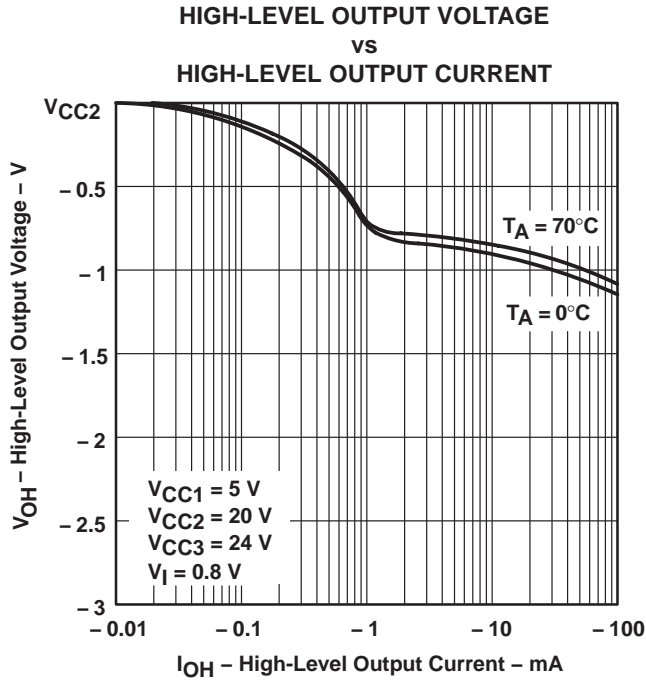

Figure 2

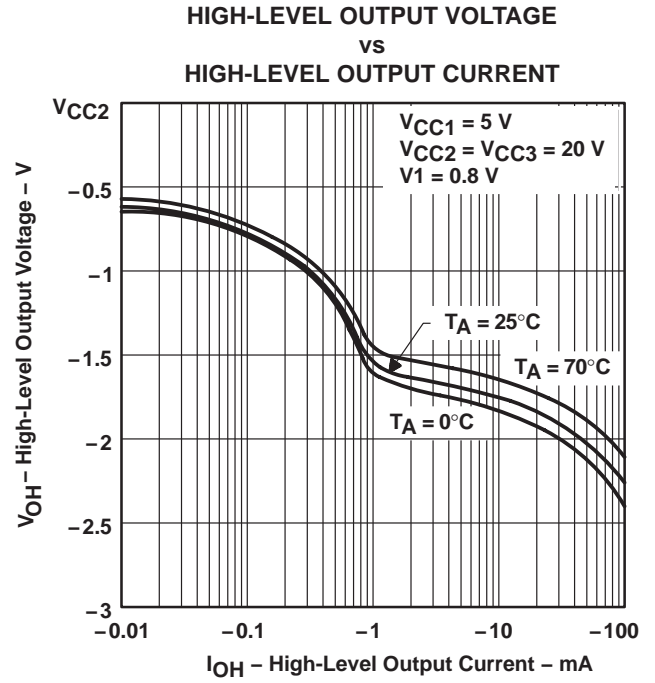

Figure 3

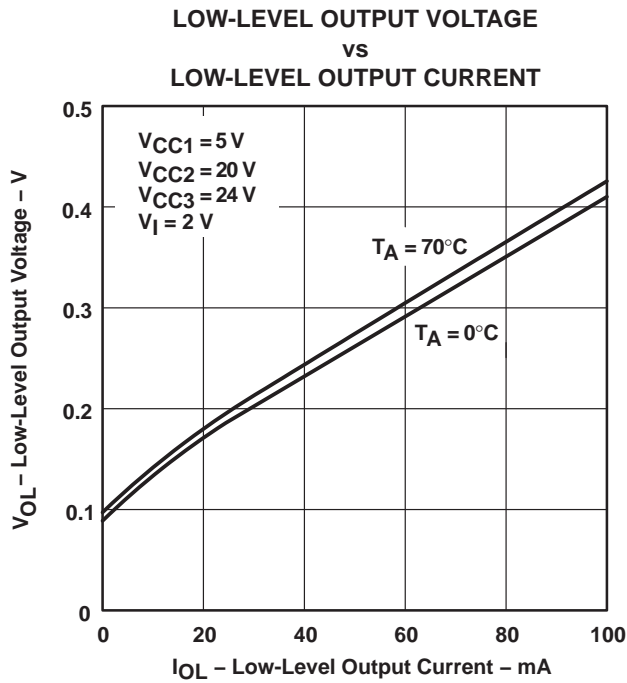

Figure 4

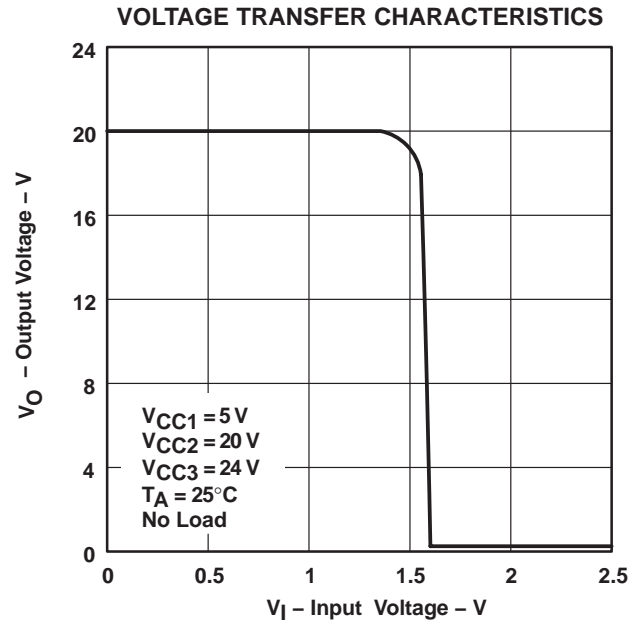

Figure 5

SN75374 QUADRUPLE MOSFET DRIVER

SLRS028A – SEPTEMBER 1988 – REVISED NOVEMBER 2004

TYPICAL CHARACTERISTICS

PROPAGATION DELAY TIME
LOW- TO HIGH-LEVEL OUTPUT
vs
FREE-AIR TEMPERATURE

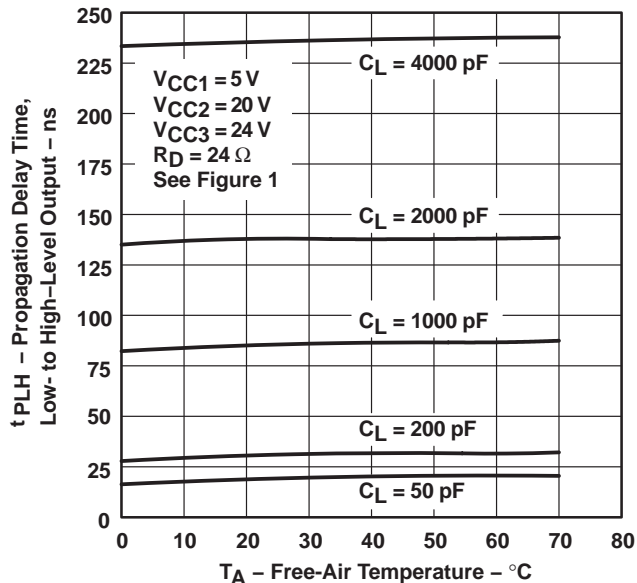

Figure 6

PROPAGATION DELAY TIME
HIGH- TO LOW-LEVEL OUTPUT
vs
FREE-AIR TEMPERATURE

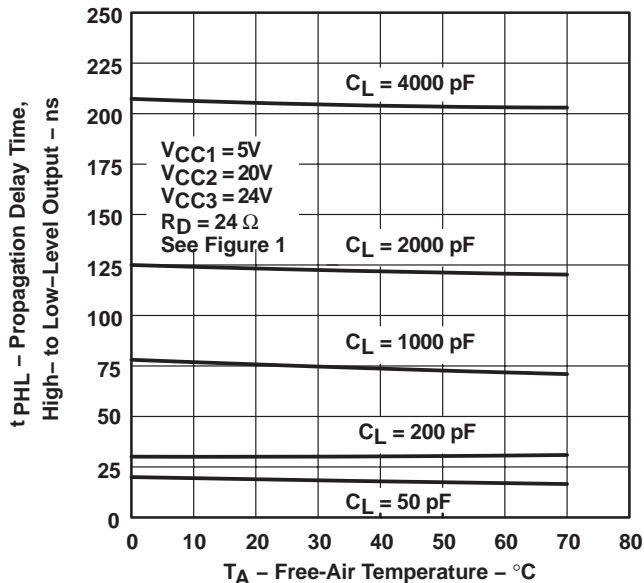

Figure 7

PROPAGATION DELAY TIME
LOW-TO HIGH-LEVEL OUTPUT
vs
 V_{CC2} SUPPLY VOLTAGE

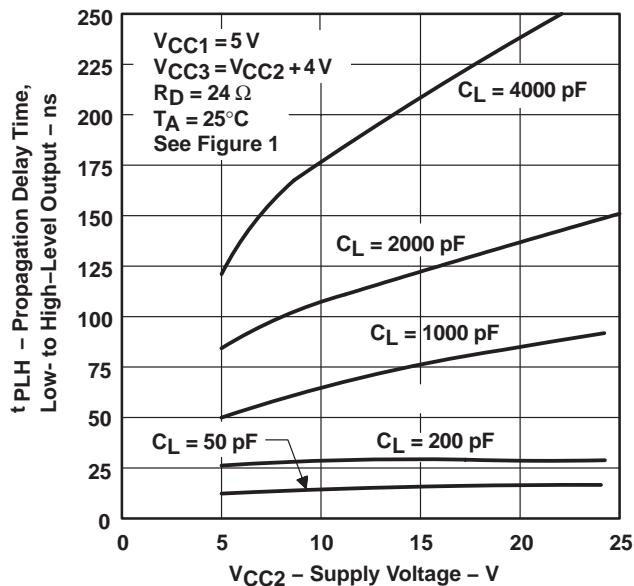

Figure 8

PROPAGATION DELAY TIME
HIGH- TO LOW-LEVEL OUTPUT
vs
 V_{CC2} SUPPLY VOLTAGE

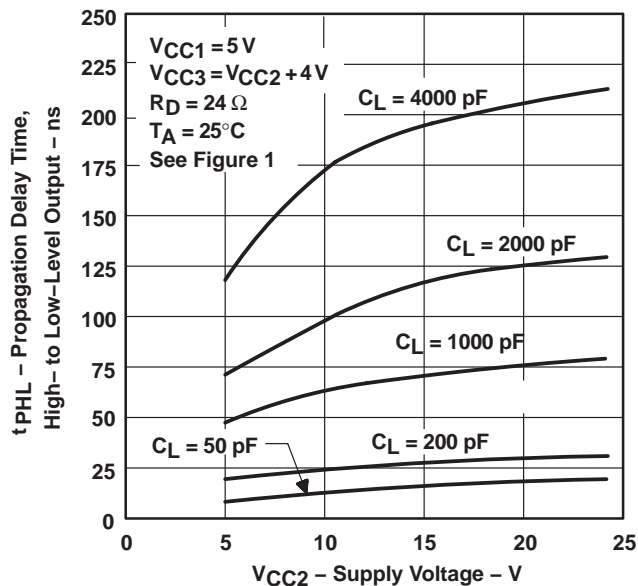

Figure 9



TYPICAL CHARACTERISTICS

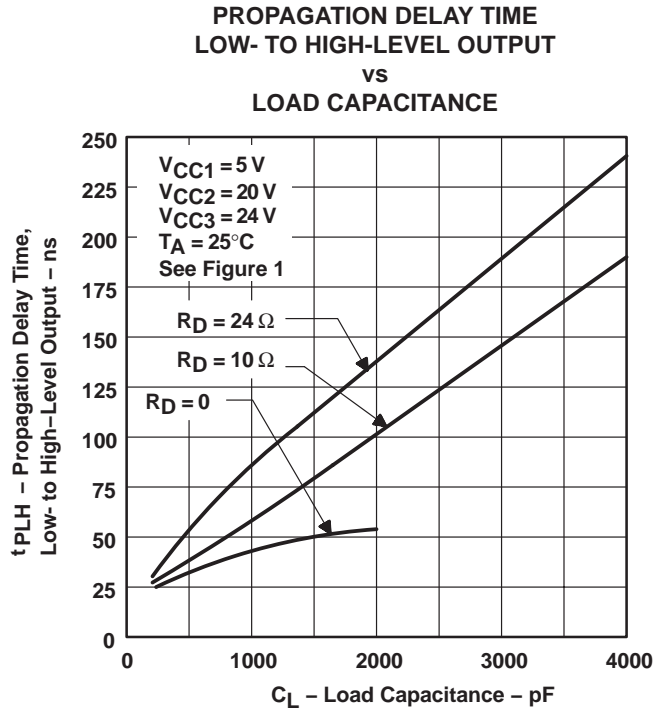

Figure 10

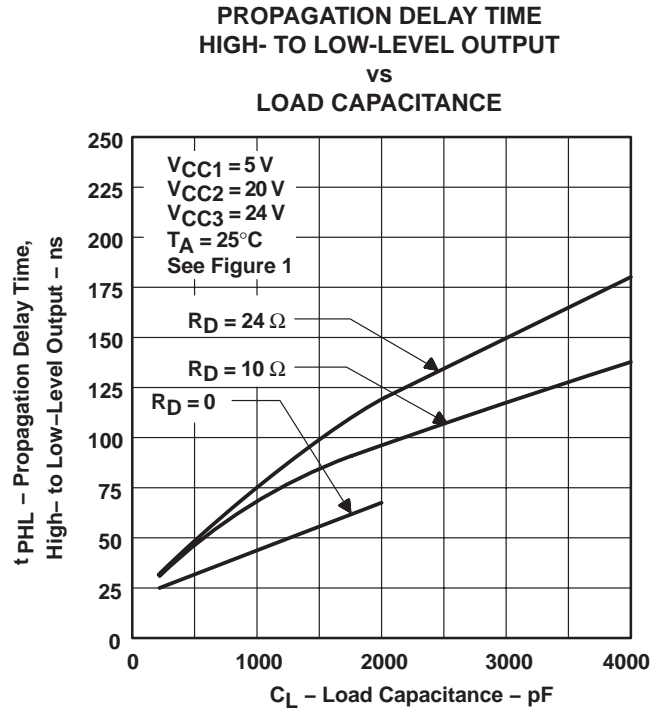

Figure 11

**POWER DISSIPATION (ALL DRIVERS)
 vs
 FREQUENCY**

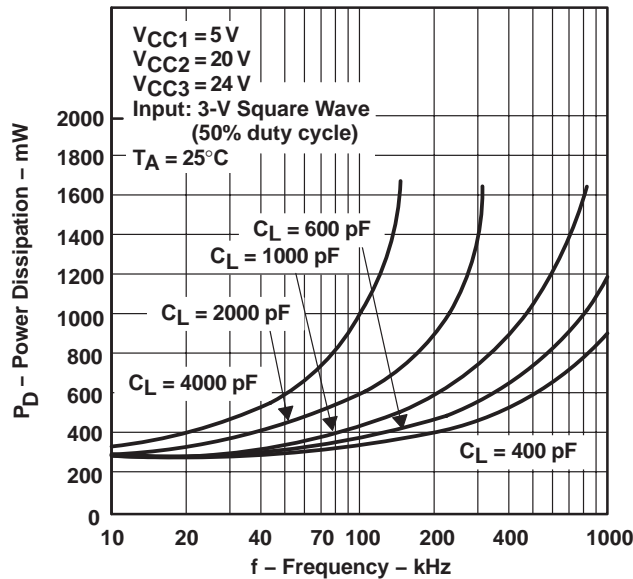

Figure 12

NOTE: For $R_D = 0$, operation with $C_L > 2000\text{ pF}$ violates absolute maximum current rating.

SN75374 QUADRUPLE MOSFET DRIVER

SLRS028A – SEPTEMBER 1988 – REVISED NOVEMBER 2004

THERMAL INFORMATION

power-dissipation precautions

Significant power may be dissipated in the SN75374 driver when charging and discharging high-capacitance loads over a wide voltage range at high frequencies. Figure 12 shows the power dissipated in a typical SN75374 as a function of frequency and load capacitance. Average power dissipated by this driver is derived from the equation:

$$P_{T(AV)} = P_{DC(AV)} + P_{C(AV)} + P_{S(AV)}$$

where $P_{DC(AV)}$ is the steady-state power dissipation with the output high or low, $P_{C(AV)}$ is the power level during charging or discharging of the load capacitance, and $P_{S(AV)}$ is the power dissipation during switching between the low and high levels. None of these include energy transferred to the load, and all are averaged over a full cycle.

The power components per driver channel are:

$$P_{DC(AV)} = \frac{(P_H t_H + P_L t_L)}{T}$$

$$P_{C(AV)} \approx CV^2 f$$

$$P_{S(AV)} = \frac{(P_{LH} t_{LH} + P_{HL} t_{HL})}{T}$$

where the times are as defined in Figure 15.

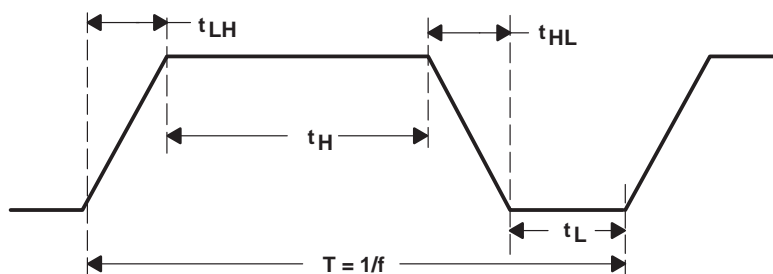

Figure 13. Output-Voltage Waveform

THERMAL INFORMATION

power-dissipation precautions (continued)

P_L , P_H , P_{LH} , and P_{HL} are the respective instantaneous levels of power dissipation, and C is the load capacitance. V_C is the voltage across the load capacitance during the charge cycle shown by the equation:

$$V_C = V_{OH} - V_{OL}$$

$P_{S(AV)}$ may be ignored for power calculations at low frequencies.

In the following power calculation, all four channels are operating under identical conditions: $f = 0.2$ MHz, $V_{OH} = 19.9$ V and $V_{OL} = 0.15$ V with $V_{CC1} = 5$ V, $V_{CC2} = 20$ V, $V_{CC3} = 24$ V, $V_C = 19.75$ V, $C = 1000$ pF, and the duty cycle = 60%. At 0.2 MHz for $C_L < 2000$ pF, $P_{S(AV)}$ is negligible and can be ignored. When the output voltage is low, I_{CC2} is negligible and can be ignored.

On a per-channel basis using data-sheet values,

$$P_{DC(AV)} = \left[5 \text{ V} \left(\frac{4 \text{ mA}}{4} \right) + 20 \text{ V} \left(\frac{-2.2 \text{ mA}}{4} \right) + 24 \text{ V} \left(\frac{2.2 \text{ mA}}{4} \right) \right] 0.6 +$$

$$\left[5 \text{ V} \left(\frac{31 \text{ mA}}{4} \right) + 20 \text{ V} \left(\frac{0 \text{ mA}}{4} \right) + 24 \text{ V} \left(\frac{16 \text{ mA}}{4} \right) \right] 0.4$$

$$P_{DC(AV)} = 58.2 \text{ mW per channel}$$

Power during the charging time of the load capacitance is

$$P_{C(AV)} = (1000 \text{ pF})(19.75 \text{ V})^2(0.2 \text{ MHz}) = 78 \text{ mW per channel}$$

Total power for each driver is:

$$P_{T(AV)} = 58.2 \text{ mW} + 78 \text{ mW} = 136.2 \text{ mW}$$

The total package power is:

$$P_{T(AV)} = (136.2)(4) = 544.8 \text{ mW}$$

SN75374 QUADRUPLE MOSFET DRIVER

SLRS028A – SEPTEMBER 1988 – REVISED NOVEMBER 2004

APPLICATION INFORMATION

driving power MOSFETs

The drive requirements of power MOSFETs are much lower than comparable bipolar power transistors. The input impedance of an FET consists of a reverse-biased PN junction that can be described as a large capacitance in parallel with a very high resistance. For this reason, the commonly used open-collector driver with a pullup resistor is not satisfactory for high-speed applications. In Figure 14a, an IRF151 power MOSFET switching an inductive load is driven by an open-collector transistor driver with a 470-Ω pullup resistor. The input capacitance (C_{ISS}) specification for an IRF151 is 4000 pF maximum. The resulting long turn-on time, due to the product of input capacitance and the pullup resistor, is shown in Figure 14b.

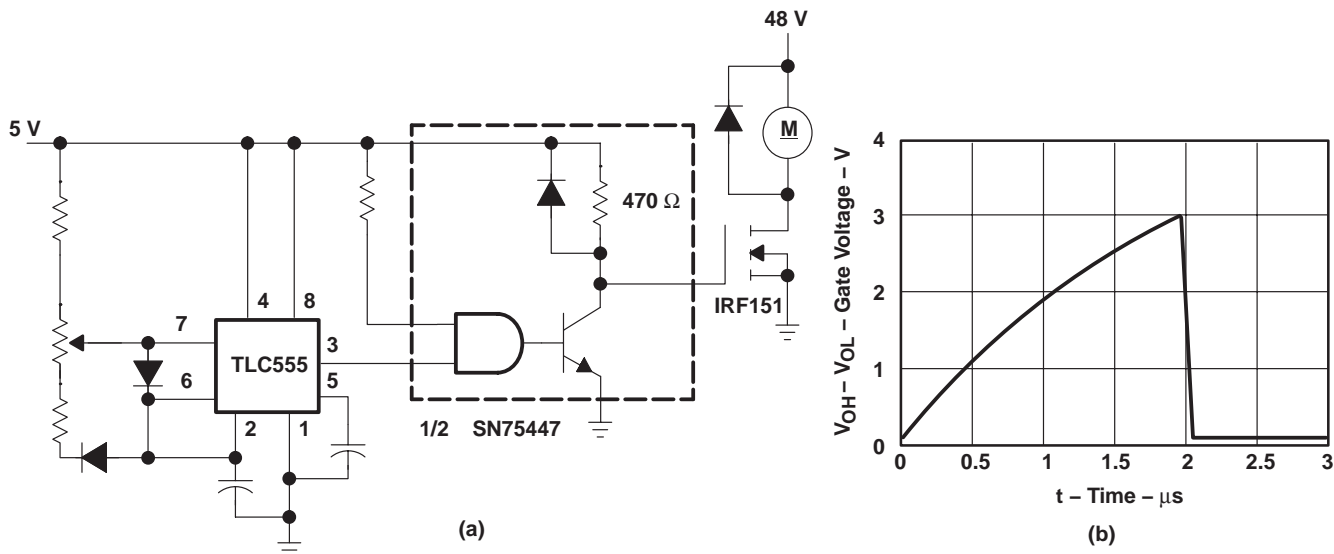

Figure 14. Power MOSFET Drive Using SN75447

A faster, more efficient drive circuit uses an active pullup, as well as an active pulldown output configuration, referred to as a totem-pole output. The SN75374 driver provides the high-speed totem-pole drive desired in an application of this type (see Figure 15a). The resulting faster switching speeds are shown in Figure 15b.

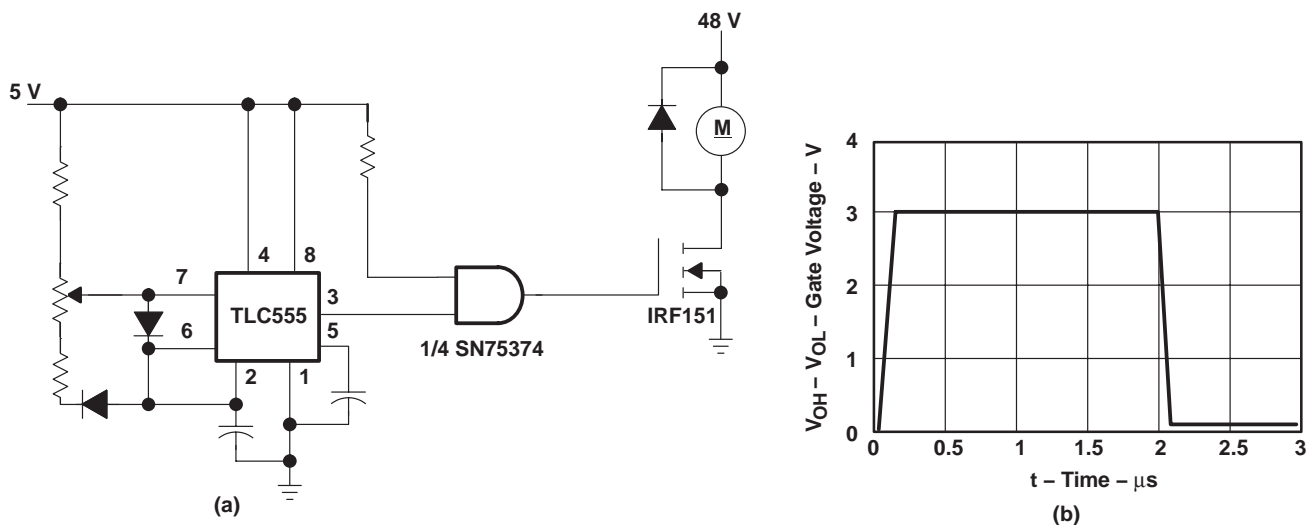

Figure 15. Power MOSFET Drive Using SN75374

APPLICATION INFORMATION

driving power MOSFETs (continued)

Power MOSFET drivers must be capable of supplying high peak currents to achieve fast switching speeds as shown by the equation:

$$I_{PK} = \frac{VC}{t_r}$$

where C is the capacitive load and t_r is the desired rise time. V is the voltage that the capacitance is charged to. In the circuit shown in Figure 14a, V is found by the equation:

$$V = V_{OH} - V_{OL}$$

Peak current required to maintain a rise time of 100 ns in the circuit of Figure 14a is:

$$I_{PK} = \frac{(3 - 0)4(10^{-9})}{100(10^{-9})} = 120 \text{ mA}$$

Circuit capacitance can be ignored because it is very small compared to the input capacitance of the IRF151. With a V_{CC} of 5 V and assuming worst-case conditions, the gate drive voltage is 3 V.

For applications in which the full voltage of V_{CC2} must be supplied to the MOSFET gate, V_{CC3} should be at least 3 V higher than V_{CC2} .

PACKAGING INFORMATION

Orderable Device	Status (1)	Package Type	Package Drawing	Pins	Package Qty	Eco Plan (2)	Lead/Ball Finish (6)	MSL Peak Temp (3)	Op Temp (°C)	Device Marking (4/5)	Samples
SN75374D	ACTIVE	SOIC	D	16	40	Green (RoHS & no Sb/Br)	CU NIPDAU	Level-1-260C-UNLIM	0 to 70	SN75374	Samples
SN75374DE4	ACTIVE	SOIC	D	16	40	Green (RoHS & no Sb/Br)	CU NIPDAU	Level-1-260C-UNLIM	0 to 70	SN75374	Samples
SN75374DG4	ACTIVE	SOIC	D	16	40	Green (RoHS & no Sb/Br)	CU NIPDAU	Level-1-260C-UNLIM	0 to 70	SN75374	Samples
SN75374DR	ACTIVE	SOIC	D	16	2500	Green (RoHS & no Sb/Br)	CU NIPDAU	Level-1-260C-UNLIM	0 to 70	SN75374	Samples
SN75374DRE4	ACTIVE	SOIC	D	16	2500	Green (RoHS & no Sb/Br)	CU NIPDAU	Level-1-260C-UNLIM	0 to 70	SN75374	Samples
SN75374DRG4	ACTIVE	SOIC	D	16	2500	Green (RoHS & no Sb/Br)	CU NIPDAU	Level-1-260C-UNLIM	0 to 70	SN75374	Samples
SN75374N	ACTIVE	PDIP	N	16	25	Pb-Free (RoHS)	CU NIPDAU	N / A for Pkg Type	0 to 70	SN75374N	Samples

(1) The marketing status values are defined as follows:

ACTIVE: Product device recommended for new designs.

LIFEBUY: TI has announced that the device will be discontinued, and a lifetime-buy period is in effect.

NRND: Not recommended for new designs. Device is in production to support existing customers, but TI does not recommend using this part in a new design.

PREVIEW: Device has been announced but is not in production. Samples may or may not be available.

OBSOLETE: TI has discontinued the production of the device.

(2) Eco Plan - The planned eco-friendly classification: Pb-Free (RoHS), Pb-Free (RoHS Exempt), or Green (RoHS & no Sb/Br) - please check <http://www.ti.com/productcontent> for the latest availability information and additional product content details.

TBD: The Pb-Free/Green conversion plan has not been defined.

Pb-Free (RoHS): TI's terms "Lead-Free" or "Pb-Free" mean semiconductor products that are compatible with the current RoHS requirements for all 6 substances, including the requirement that lead not exceed 0.1% by weight in homogeneous materials. Where designed to be soldered at high temperatures, TI Pb-Free products are suitable for use in specified lead-free processes.

Pb-Free (RoHS Exempt): This component has a RoHS exemption for either 1) lead-based flip-chip solder bumps used between the die and package, or 2) lead-based die adhesive used between the die and leadframe. The component is otherwise considered Pb-Free (RoHS compatible) as defined above.

Green (RoHS & no Sb/Br): TI defines "Green" to mean Pb-Free (RoHS compatible), and free of Bromine (Br) and Antimony (Sb) based flame retardants (Br or Sb do not exceed 0.1% by weight in homogeneous material)

(3) MSL, Peak Temp. - The Moisture Sensitivity Level rating according to the JEDEC industry standard classifications, and peak solder temperature.

(4) There may be additional marking, which relates to the logo, the lot trace code information, or the environmental category on the device.

⁽⁵⁾ Multiple Device Markings will be inside parentheses. Only one Device Marking contained in parentheses and separated by a "-" will appear on a device. If a line is indented then it is a continuation of the previous line and the two combined represent the entire Device Marking for that device.

⁽⁶⁾ Lead/Ball Finish - Orderable Devices may have multiple material finish options. Finish options are separated by a vertical ruled line. Lead/Ball Finish values may wrap to two lines if the finish value exceeds the maximum column width.

Important Information and Disclaimer:The information provided on this page represents TI's knowledge and belief as of the date that it is provided. TI bases its knowledge and belief on information provided by third parties, and makes no representation or warranty as to the accuracy of such information. Efforts are underway to better integrate information from third parties. TI has taken and continues to take reasonable steps to provide representative and accurate information but may not have conducted destructive testing or chemical analysis on incoming materials and chemicals. TI and TI suppliers consider certain information to be proprietary, and thus CAS numbers and other limited information may not be available for release.

In no event shall TI's liability arising out of such information exceed the total purchase price of the TI part(s) at issue in this document sold by TI to Customer on an annual basis.

TAPE AND REEL INFORMATION



QUADRANT ASSIGNMENTS FOR PIN 1 ORIENTATION IN TAPE



*All dimensions are nominal

Device	Package Type	Package Drawing	Pins	SPQ	Reel Diameter (mm)	Reel Width W1 (mm)	A0 (mm)	B0 (mm)	K0 (mm)	P1 (mm)	W (mm)	Pin1 Quadrant
SN75374DR	SOIC	D	16	2500	330.0	16.4	6.5	10.3	2.1	8.0	16.0	Q1

TAPE AND REEL BOX DIMENSIONS



*All dimensions are nominal

Device	Package Type	Package Drawing	Pins	SPQ	Length (mm)	Width (mm)	Height (mm)
SN75374DR	SOIC	D	16	2500	333.2	345.9	28.6

N (R-PDIP-T**)

PLASTIC DUAL-IN-LINE PACKAGE

16 PINS SHOWN



- NOTES:
- A. All linear dimensions are in inches (millimeters).
 - B. This drawing is subject to change without notice.
 - Falls within JEDEC MS-001, except 18 and 20 pin minimum body length (Dim A).
 - The 20 pin end lead shoulder width is a vendor option, either half or full width.

D (R-PDSO-G16)

PLASTIC SMALL OUTLINE



- NOTES:
- A. All linear dimensions are in inches (millimeters).
 - B. This drawing is subject to change without notice.
 - C. Body length does not include mold flash, protrusions, or gate burrs. Mold flash, protrusions, or gate burrs shall not exceed 0.006 (0,15) each side.
 - D. Body width does not include interlead flash. Interlead flash shall not exceed 0.017 (0,43) each side.
 - E. Reference JEDEC MS-012 variation AC.

D (R-PDSO-G16)

PLASTIC SMALL OUTLINE



- NOTES:
- A. All linear dimensions are in millimeters.
 - B. This drawing is subject to change without notice.
 - C. Publication IPC-7351 is recommended for alternate designs.
 - D. Laser cutting apertures with trapezoidal walls and also rounding corners will offer better paste release. Customers should contact their board assembly site for stencil design recommendations. Refer to IPC-7525 for other stencil recommendations.
 - E. Customers should contact their board fabrication site for solder mask tolerances between and around signal pads.

IMPORTANT NOTICE

Texas Instruments Incorporated and its subsidiaries (TI) reserve the right to make corrections, enhancements, improvements and other changes to its semiconductor products and services per JESD46, latest issue, and to discontinue any product or service per JESD48, latest issue. Buyers should obtain the latest relevant information before placing orders and should verify that such information is current and complete. All semiconductor products (also referred to herein as "components") are sold subject to TI's terms and conditions of sale supplied at the time of order acknowledgment.

TI warrants performance of its components to the specifications applicable at the time of sale, in accordance with the warranty in TI's terms and conditions of sale of semiconductor products. Testing and other quality control techniques are used to the extent TI deems necessary to support this warranty. Except where mandated by applicable law, testing of all parameters of each component is not necessarily performed.

TI assumes no liability for applications assistance or the design of Buyers' products. Buyers are responsible for their products and applications using TI components. To minimize the risks associated with Buyers' products and applications, Buyers should provide adequate design and operating safeguards.

TI does not warrant or represent that any license, either express or implied, is granted under any patent right, copyright, mask work right, or other intellectual property right relating to any combination, machine, or process in which TI components or services are used. Information published by TI regarding third-party products or services does not constitute a license to use such products or services or a warranty or endorsement thereof. Use of such information may require a license from a third party under the patents or other intellectual property of the third party, or a license from TI under the patents or other intellectual property of TI.

Reproduction of significant portions of TI information in TI data books or data sheets is permissible only if reproduction is without alteration and is accompanied by all associated warranties, conditions, limitations, and notices. TI is not responsible or liable for such altered documentation. Information of third parties may be subject to additional restrictions.

Resale of TI components or services with statements different from or beyond the parameters stated by TI for that component or service voids all express and any implied warranties for the associated TI component or service and is an unfair and deceptive business practice. TI is not responsible or liable for any such statements.

Buyer acknowledges and agrees that it is solely responsible for compliance with all legal, regulatory and safety-related requirements concerning its products, and any use of TI components in its applications, notwithstanding any applications-related information or support that may be provided by TI. Buyer represents and agrees that it has all the necessary expertise to create and implement safeguards which anticipate dangerous consequences of failures, monitor failures and their consequences, lessen the likelihood of failures that might cause harm and take appropriate remedial actions. Buyer will fully indemnify TI and its representatives against any damages arising out of the use of any TI components in safety-critical applications.

In some cases, TI components may be promoted specifically to facilitate safety-related applications. With such components, TI's goal is to help enable customers to design and create their own end-product solutions that meet applicable functional safety standards and requirements. Nonetheless, such components are subject to these terms.

No TI components are authorized for use in FDA Class III (or similar life-critical medical equipment) unless authorized officers of the parties have executed a special agreement specifically governing such use.

Only those TI components which TI has specifically designated as military grade or "enhanced plastic" are designed and intended for use in military/aerospace applications or environments. Buyer acknowledges and agrees that any military or aerospace use of TI components which have *not* been so designated is solely at the Buyer's risk, and that Buyer is solely responsible for compliance with all legal and regulatory requirements in connection with such use.

TI has specifically designated certain components as meeting ISO/TS16949 requirements, mainly for automotive use. In any case of use of non-designated products, TI will not be responsible for any failure to meet ISO/TS16949.

Products

Audio	www.ti.com/audio
Amplifiers	amplifier.ti.com
Data Converters	dataconverter.ti.com
DLP® Products	www.dlp.com
DSP	dsp.ti.com
Clocks and Timers	www.ti.com/clocks
Interface	interface.ti.com
Logic	logic.ti.com
Power Mgmt	power.ti.com
Microcontrollers	microcontroller.ti.com
RFID	www.ti-rfid.com
OMAP Applications Processors	www.ti.com/omap
Wireless Connectivity	www.ti.com/wirelessconnectivity

Applications

Automotive and Transportation	www.ti.com/automotive
Communications and Telecom	www.ti.com/communications
Computers and Peripherals	www.ti.com/computers
Consumer Electronics	www.ti.com/consumer-apps
Energy and Lighting	www.ti.com/energy
Industrial	www.ti.com/industrial
Medical	www.ti.com/medical
Security	www.ti.com/security
Space, Avionics and Defense	www.ti.com/space-avionics-defense
Video and Imaging	www.ti.com/video

TI E2E Community

e2e.ti.com