

SKKT 460, SKKH 460



SEMIPACK[®] 5

Thyristor / Diode Modules

SKKT 460

SKKH 460

Features

- Heat transfer through aluminium nitride ceramic insulated metal baseplate
- Precious metal pressure contacts for high reliability
- UL recognized, file no. E63532

Typical Applications*

- AC motor softstarters
- Input converters for AC inverter drives
- DC motor control (e.g. for machine tools)
- Temperature control (e.g. for ovens, chemical processes)
- Professionals light dimming (studios, theaters)

1) see assembly instructions

| V_{RSM} V | V_{RRM}, V_{DRM} V | $I_{TRMS} = 800$ A (maximum value for continuous operation) $I_{TAV} = 460$ A (sin. 180; $T_c = 85$ °C) | |
|----------------|-------------------------|--|-----------------|
| 1700 | 1600 | SKKT 460/16E | SKKH 460/16E |
| 2300 | 2200 | SKKT 460/22E H4 | SKKH 460/22E H4 |

| Symbol | Conditions | Values | Units |
|------------------|--|-----------------------|--------------------------------------|
| I_{TAV} | sin. 180; $T_c = 85$ (100) °C; | 460 (335) | A |
| I_{TSM} | $T_{vj} = 25$ °C; 10 ms $T_{vj} = 130$ °C; 10 ms | 18000 15500 | A A |
| i^2t | $T_{vj} = 25$ °C; 8,3 .. 10 ms $T_{vj} = 130$ °C; 8,3 ... 10 ms | 1620000 1200000 | A ² s A ² s |
| V_T | $T_{vj} = 25$ °C; $I_T = 1400$ A | max. 1,6 | V |
| $V_{T(TO)}$ | $T_{vj} = 130$ °C | max. 0,88 | V |
| r_T | $T_{vj} = 130$ °C | max. 0,45 | mΩ |
| $I_{DD}; I_{RD}$ | $T_{vj} = 130$ °C; $V_{RD} = V_{RRM}; V_{DD} = V_{DRM}$ | max. 240 | mA |
| t_{gd} | $T_{vj} = 25$ °C; $I_G = 1$ A; $di_G/dt = 1$ A/μs | 1 | μs |
| t_{gr} | $V_D = 0,67 * V_{DRM}$ | 2 | μs |
| $(di/dt)_{cr}$ | $T_{vj} = 130$ °C | max. 250 | A/μs |
| $(dv/dt)_{cr}$ | $T_{vj} = 130$ °C | max. 1000 | V/μs |
| t_q | $T_{vj} = 130$ °C | 100 .. 200 | μs |
| I_H | $T_{vj} = 25$ °C; typ. / max. | 150 / 500 | mA |
| I_L | $T_{vj} = 25$ °C; $R_G = 33$ Ω; typ. / max. | 300 / 2000 | mA |
| V_{GT} | $T_{vj} = 25$ °C; d.c. | min. 3 | V |
| I_{GT} | $T_{vj} = 25$ °C; d.c. | min. 200 | mA |
| V_{GD} | $T_{vj} = 130$ °C; d.c. | max. 0,25 | V |
| I_{GD} | $T_{vj} = 130$ °C; d.c. | max. 10 | mA |
| $R_{th(j-c)}$ | cont.; per thyristor / per module | 0,072 / 0,035 | K/W |
| $R_{th(j-c)}$ | sin. 180°; per thyristor / per module | 0,074 / 0,037 | K/W |
| $R_{th(j-c)}$ | rec. 120°; per thyristor / per module | 0,078 / 0,039 | K/W |
| $R_{th(c-s)}$ | per thyristor / per module | 0,02 / 0,01 | K/W |
| T_{vj} | | - 40 ... + 130 | °C |
| T_{stg} | | - 40 ... + 125 | °C |
| V_{isol} | a.c. 50 Hz; r.m.s.; 1 s / 1 min. | 3600 / 3000 | V~ |
| V_{isol} | a.c. 50 Hz; r.m.s.; 1 s / 1 min. for SKK...H4 | 4800 / 4000 | V~ |
| M_s | to heatsink | 5 ± 15% ¹⁾ | Nm |
| M_t | to terminals | 12 ± 15% | Nm |
| a | | 5 * 9,81 | m/s ² |
| m | approx. | 1400 | g |
| Case | SKKT SKKH | A 60b A 66b | |

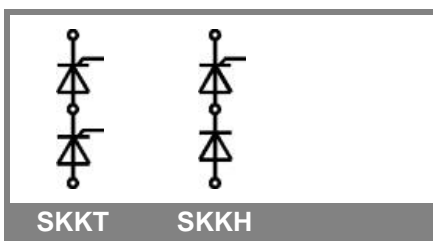

SKKT

SKKH

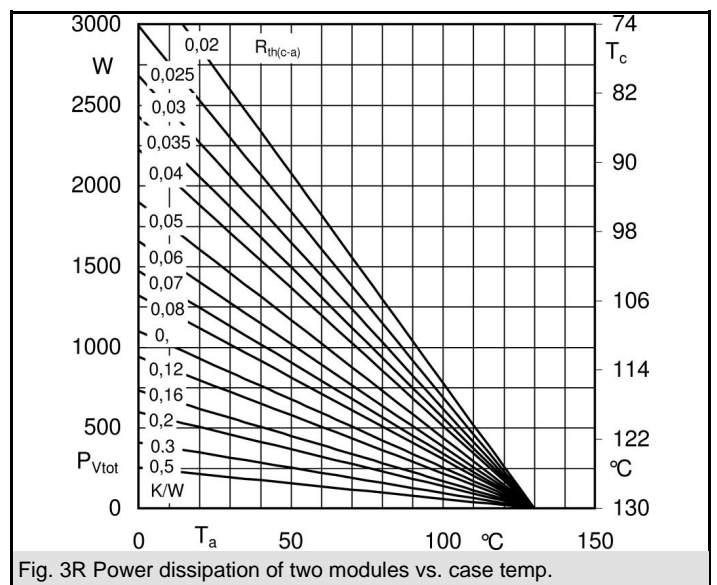
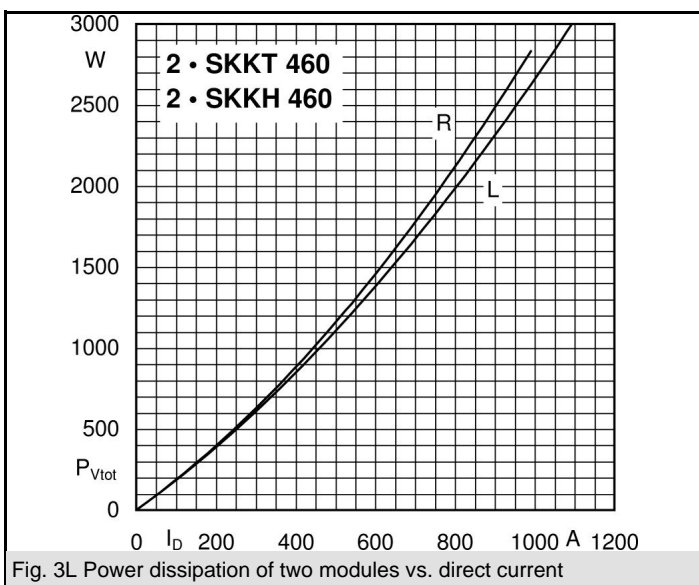
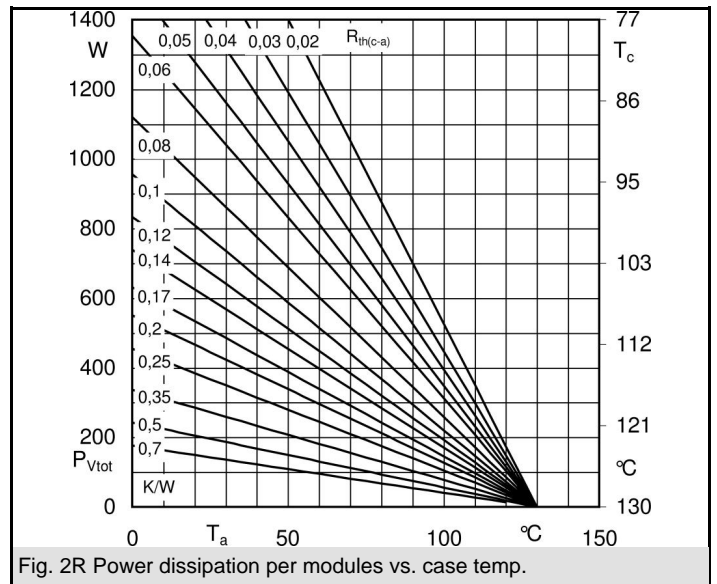
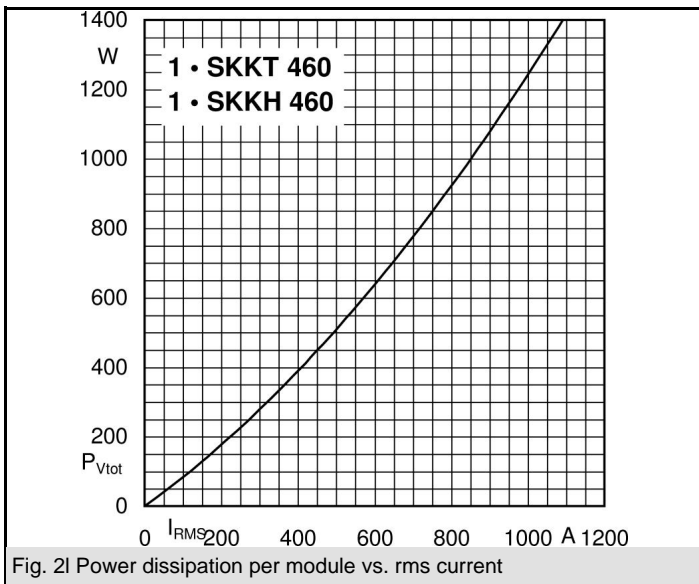
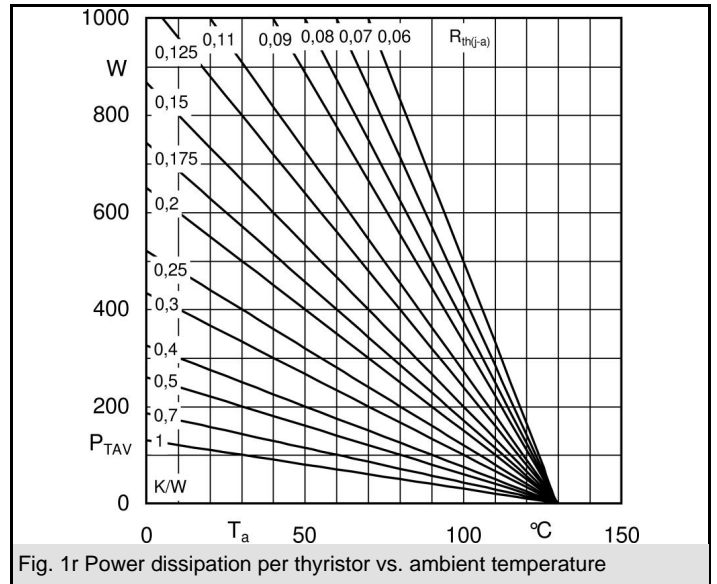
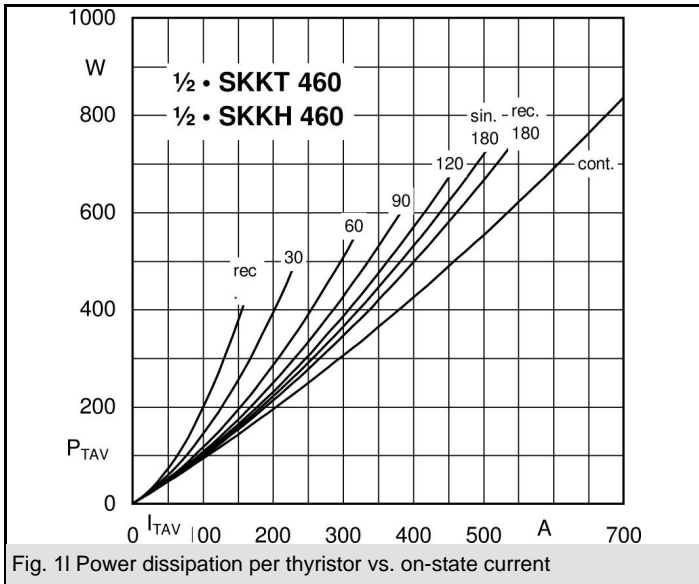

SKKT 460, SKKH 460

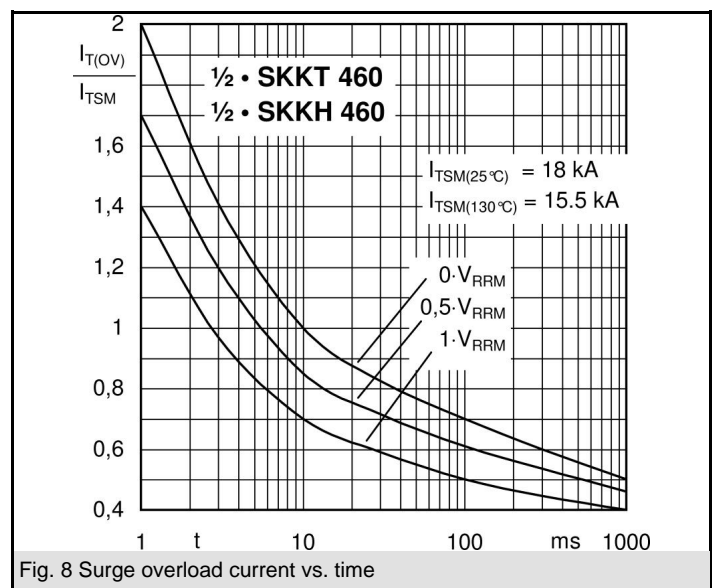
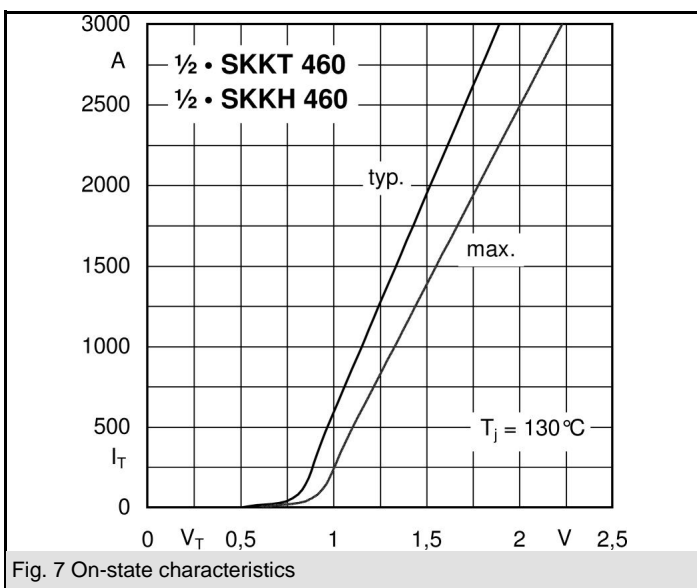
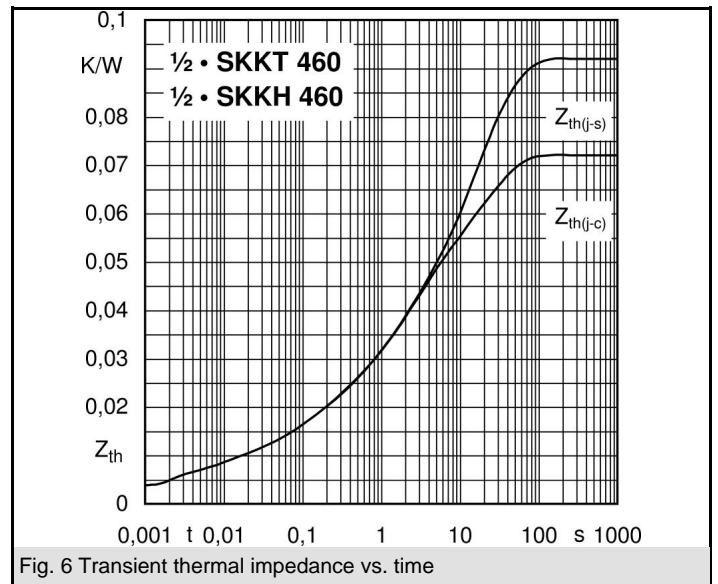
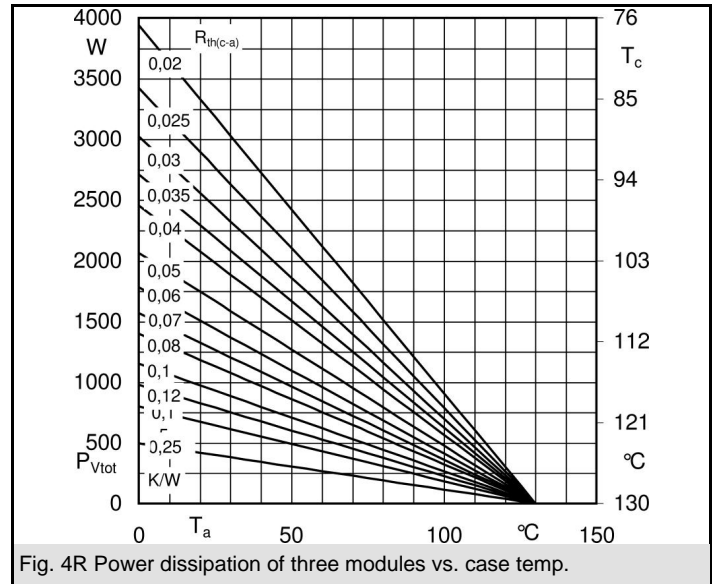
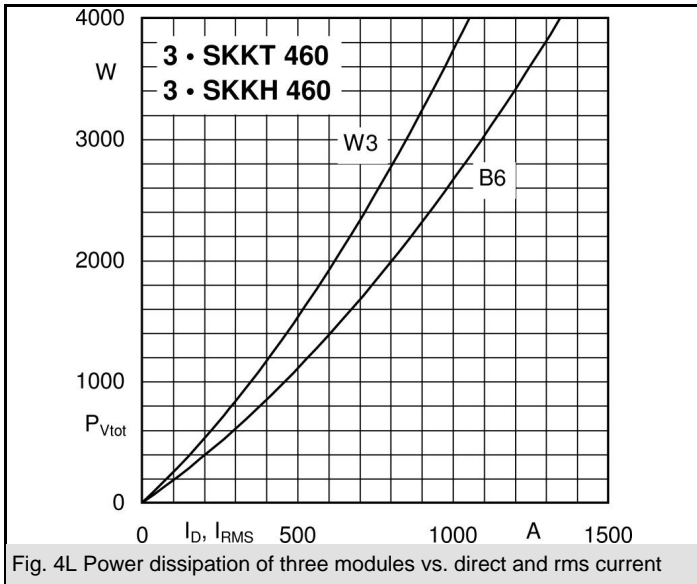

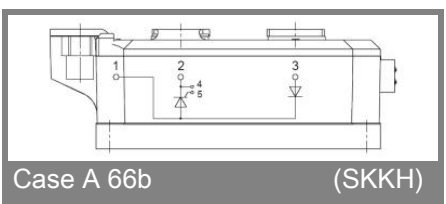
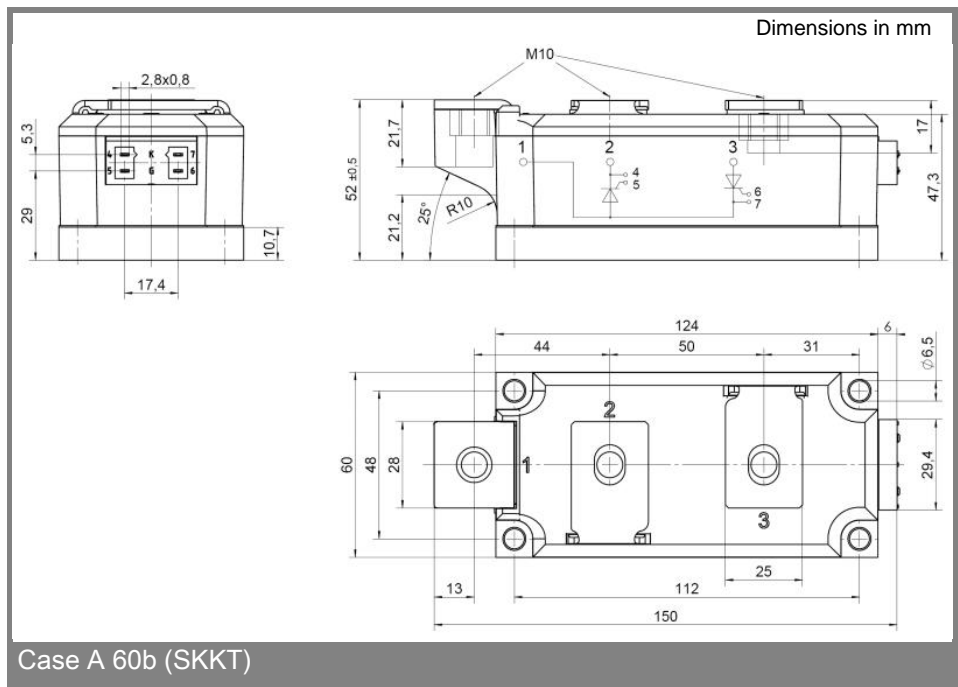
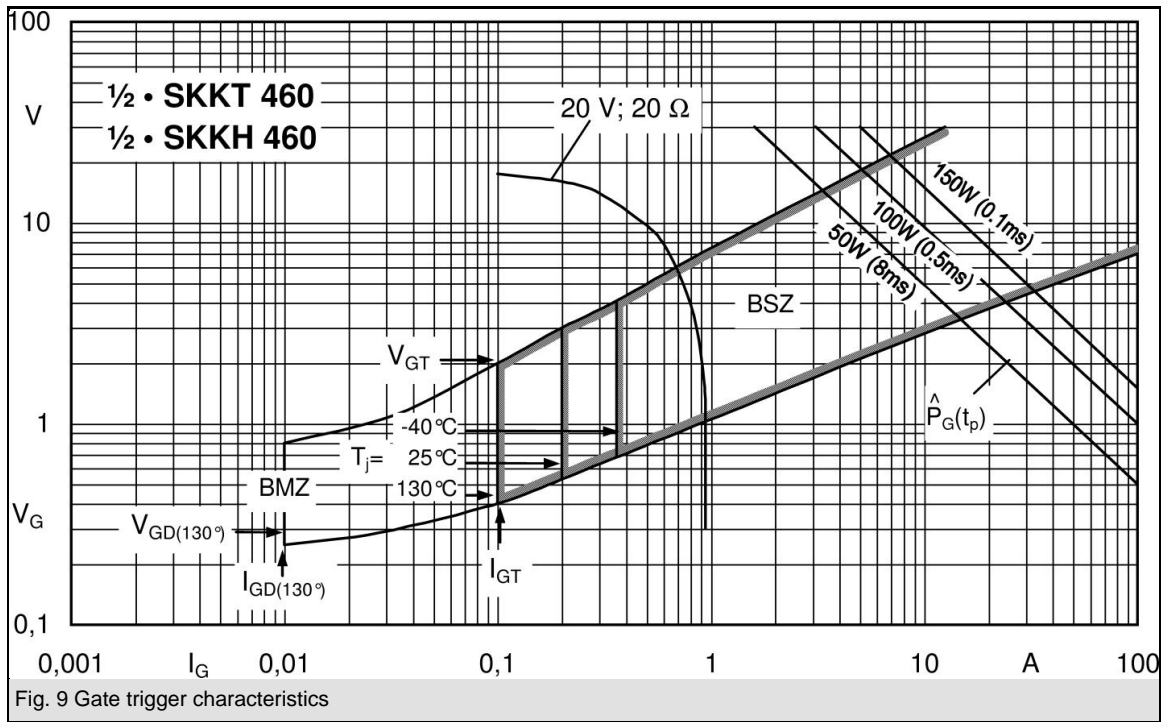

* The specifications of our components may not be considered as an assurance of component characteristics. Components have to be tested for the respective application. Adjustments may be necessary. The use of SEMIKRON products in life support appliances and systems is subject to prior specification and written approval by SEMIKRON. We therefore strongly recommend prior consultation of our staff.