

SKKD 105F, SKMD 105F, SKND 105F

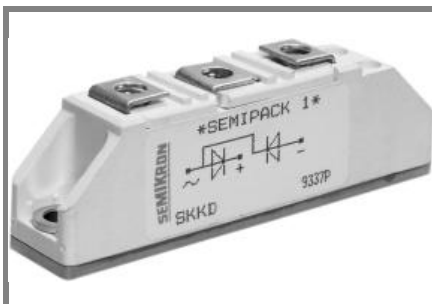

SEMIPACK® 1

Fast Diode Modules

SKKD 105F

SKMD 105F

SKND 105F

Features

- Heat transfer through ceramic isolated metal baseplate
- Hard soldered joints for high reliability
- SKKD half bridge connection; centre tap connections: SKMD common cathode, SKND common anode
- UL recognized, file no. E 63 532

Typical Applications*

- Self-commutated inverters
- DC choppers
- AC motor speed control
- Inductive heating
- Uninterruptible power supplies
- Electronic welders
- General power switching applications

V_{RSM} V	V_{RRM} V	$I_{FRMS} = 200$ A (maximum value for continuous operation)		
		$I_{FAV} = 105$ A (sin. 180; $T_c = 83$ °C)		
800	800	SKKD 105F08	SKMD 105F08	SKND 105F08
1000	1000	SKKD 105F10	SKMD 105F10	SKND 105F10
1200	1200	SKKD 105F12	SKMD 105F12	SKND 105F12
1600	1600	SKKD 105F16		

Symbol	Conditions	Values	Units
I_{FAV}	sin. 180; $T_c = 85$ (100) °C	102 (65)	A
I_{FSM}	$T_{vj} = 25$ °C; 10 ms	2500	A
	$T_{vj} = 130$ °C; 10 ms	2100	A
i^2t	$T_{vj} = 25$ °C; 8,3 ... 10 ms	31250	A ² s
	$T_{vj} = 130$ °C; 8,3 ... 10 ms	22000	A ² s
V_F	$T_{vj} = 25$ °C; $I_F = 300$ A	max. 2,05	V
$V_{(TO)}$	$T_{vj} = 130$ °C	max. 1,2	V
r_T	$T_{vj} = 130$ °C	max. 2,5	mΩ
I_{RD}	$T_{vj} = 25$ °C; $V_{RD} = V_{RRM}$	max. 1	mA
I_{RD}	$T_{vj} = 130$ °C; $V_{RD} = V_{RRM}$	max. 30	mA
Q_{rr}	$T_{vj} = 130$ °C; $I_F = 100$ A,	50	μC
I_{RM}	$-di/dt = 50$ A/μs, $V_R = 30$ V	53	A
t_{rr}		1890	ns
E_{rr}		0,8	mJ
$R_{th(j-c)}$	per diode / per module	0,24 / 0,12	K/W
$R_{th(c-s)}$	per diode / per module	0,2 / 0,1	K/W
T_{vj}		- 40 ... + 130	°C
T_{stg}		- 40 ... + 125	°C
V_{isol}	a. c. 50 Hz; r.m.s; 1 s / 1 min.	3600 / 3000	V~
M_s	to heatsink	5 ± 15 %	Nm
M_t	to terminals	3 ± 15 %	Nm
a		5 * 9,81	m/s ²
m	approx.	120	g
Case	SKKD	A 10	
	SKMD	A 33	
	SKND	A 37	

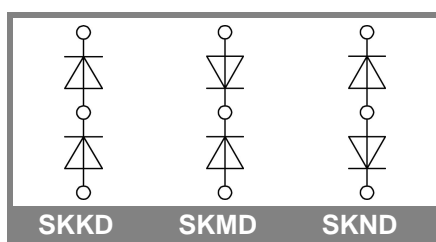

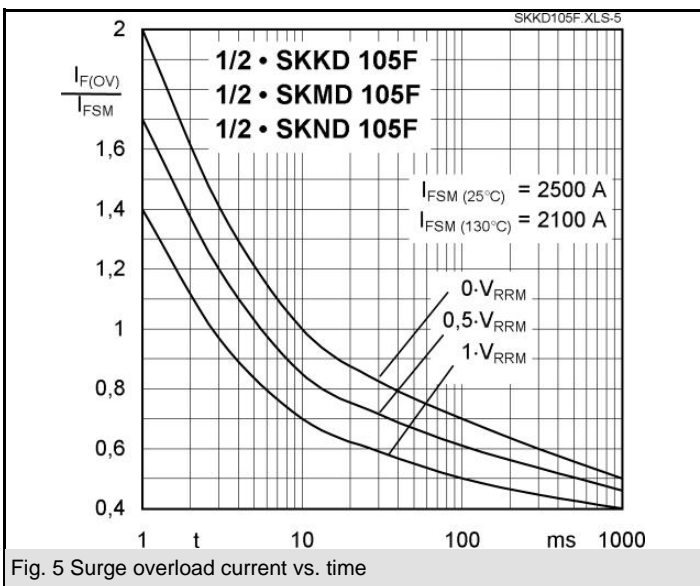
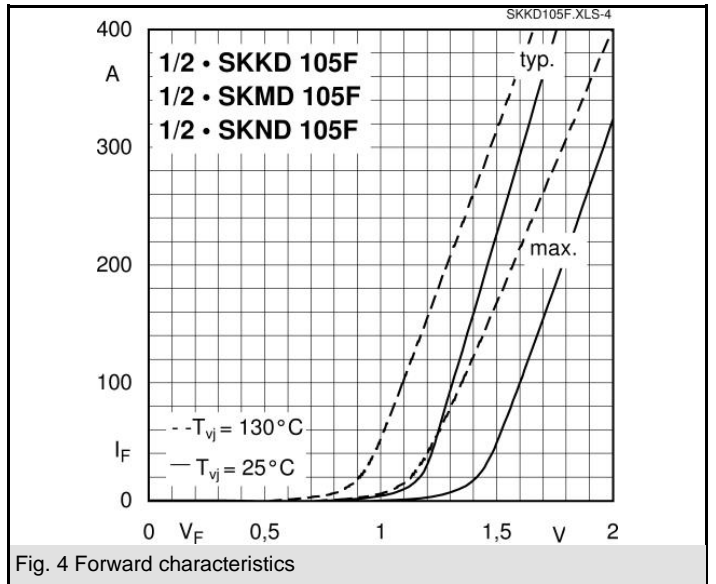
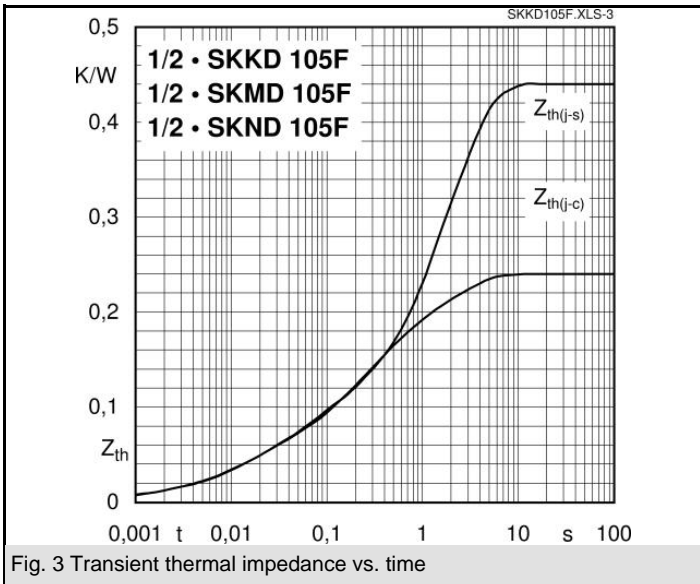
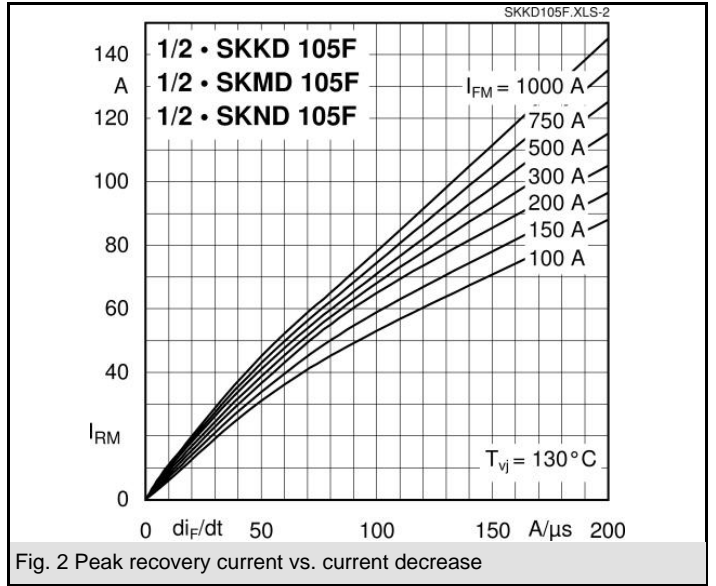
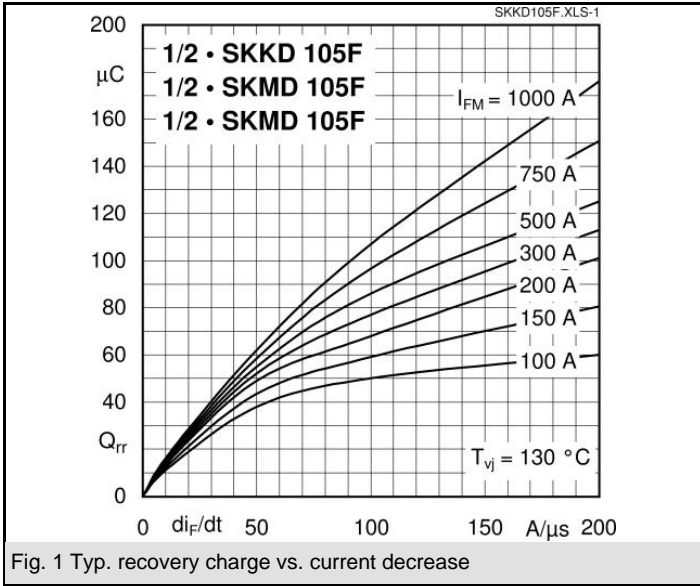

SKKD 105F, SKMD 105F, SKND 105F

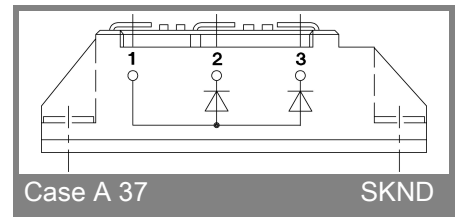
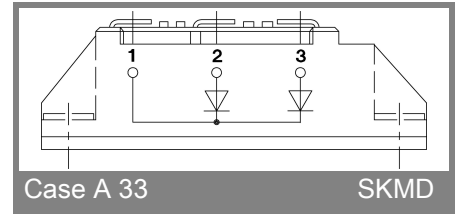
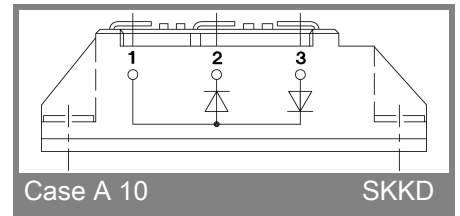
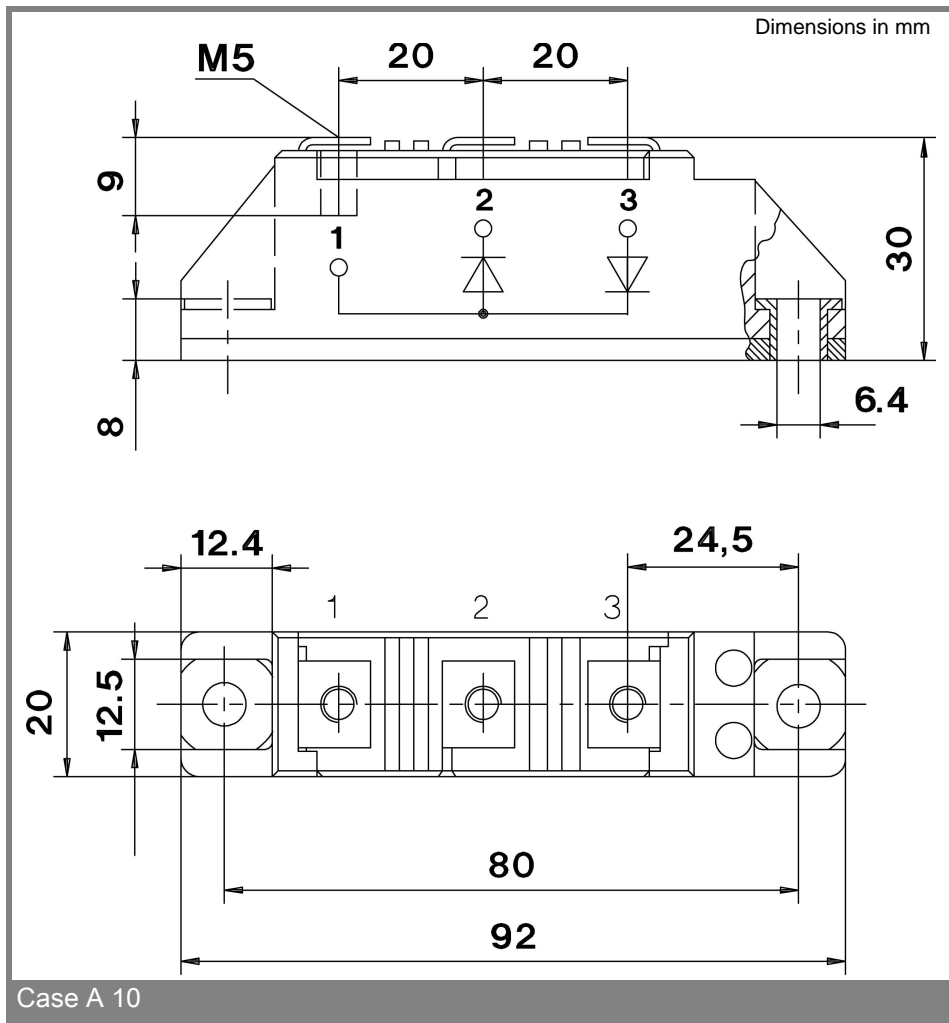

* The specifications of our components may not be considered as an assurance of component characteristics. Components have to be tested for the respective application. Adjustments may be necessary. The use of SEMIKRON products in life support appliances and systems is subject to prior specification and written approval by SEMIKRON. We therefore strongly recommend prior consultation of our personal.