

RE.F5

Mould-on polyurethan wheels

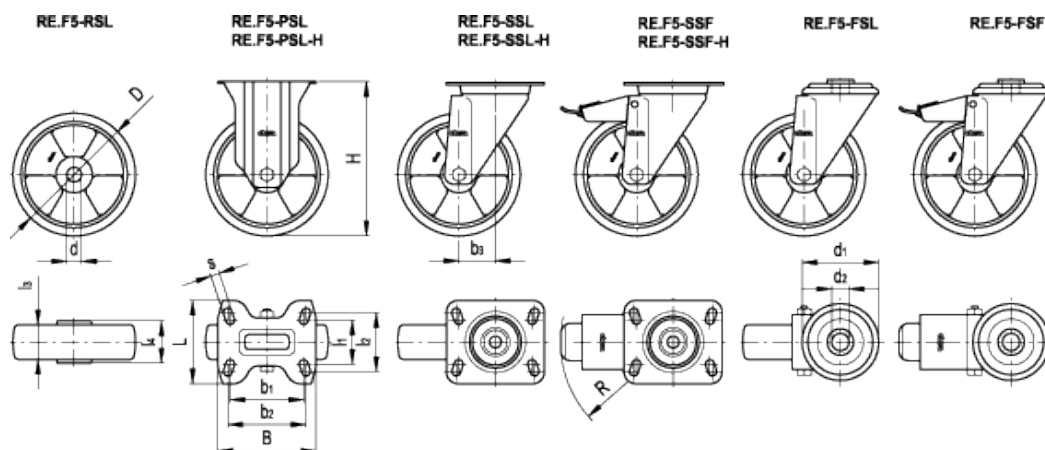

technical informations

Covering

Mould-on polyurethane, hardness 95 Shore A.

Centre

Die-cast aluminium.

Bore and axle

The axle is mounted using a calibrated tube processed to obtain an even surface where roller bearings and spacers are inserted. Screw and nut are tightened to lock the spacer and the roller bearings. Ideal solution for large loads and continuous moving.

Standard executions

- RSL: wheel only.
- PSL: brakeless wheel with zinc-plated steel fixed bracket.
- SSL: brakeless wheel with zinc-plated steel turning plate and bracket.
- SSF: wheel with brake and zinc-plated steel turning plate and bracket.
- FSL: brakeless wheel with zinc-plated steel turning plate with bracket and assembly pass through hole.

- FSF: wheel with brake and zinc-plated steel turning plate and bracket, assembly pass through hole.
- PSL-H: brakeless wheel with zinc-plated steel fixed bracket for heavy loads.
- SSL-H: brakeless wheel with zinc-plated steel turning plate and bracket for heavy loads.
- SSF-H: wheel with brake and zinc-plated steel turning plate and bracket for heavy loads.

Fixed plate bracket

- Standard bracket: zinc-plated steel plate, the bracket is designed to withstand loads up to 4000N. The bracket load capacity is greater than the dynamic carrying capacity of the wheel assembly plus the bracket (see table), this is a further safety feature.
- Bracket type H: tropical galvanisation steel plate (test in saline fog chamber above 72h). The bracket is designed to withstand loads up to 7500N. The bracket load capacity is greater than the dynamic carrying capacity of the wheel assembly plus the bracket (see table), this is a further safety feature. Ensures capacities that make it suitable for heavy industrial applications.

Turning plate bracket

- Standard bracket: zinc-plated steel plate, the bracket is designed to withstand loads up to 4000N. The bracket load capacity is greater than the dynamic carrying capacity of the wheel assembly plus the bracket (see table), this is a further safety feature.
- The presence of two ball turns and the direct contact between the plate and the ball race ring with built-in pin ensure excellent manoeuvrability and very limited clearance (see fig. 1). Does not require maintenance.

It consists of:

- 1) Bracket: electrolytically zinc-plated steel plate.
- 2) Fork: electrolytically zinc-plated steel plate.
- 3) Ball race ring: electrolytically zinc-plated steel plate.
- 4) Central pin: incorporated in the plate, cold reflanged.
- 5) Fitting plate: dual grease-lubricated ring of ball.
- 6) Dust seal: RAL 7015 dark grey technopolymer.

- Bracket type H: the bracket is designed to withstand loads up to 7500N. The bracket load capacity is greater than the dynamic carrying capacity of the wheel assembly plus the bracket (see table), this is a further safety feature. Ensures capacities that make it suitable for heavy industrial applications (see fig. 2).

It consists of:

- 1) Plate: tropical zinc-plated steel plate.
- 2) Fork: tropical zinc-plated steel plate.
- 3) Ball race ring: tropical zinc-plated steel plate.
- 4) Central pin: class 8.8 steel screw and steel nut.
- 5) Fitting plate: dual grease-lubricated ring of ball.
- 6) Dust seal: RAL 7015 dark grey technopolymer

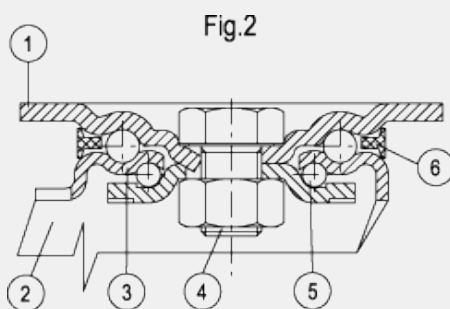
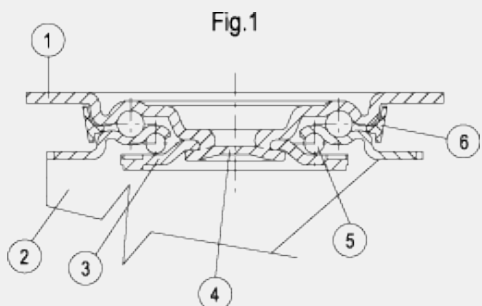

Brake

- Standard bracket: total brake that locks the wheel and bracket rotation. The optimised dimensions and the retractible pedal ensure minimal space occupied and maximum actuation ease. In order to optimise the wheel lock in both directions of rotation, the spring is fitted with a dual braking tooth. Hardened carbon steel spring.
- Type H. bracket, dual-effect brake with simultaneous locking of wheel and bracket. Pushing the trolley, the rear brake is not within the operator's reach as it stays under the trolley. The trolley must be turned to use the device. The brake is simple and effective to use: it is actuated and released by a simple action from the top downward at the tip of two separate pedals, thus ensuring the utmost manoeuvring comfort. The braking efficacy may be adjusted with a socket head screw M8.

Applications

Excellent smoothness and elasticity features, high wear and tearing resistance.

Environmental conditions

The wheel RE.F5 is suitable for use in environments with the presence of atmospheric agents, alcohols and glycols; use in environments with the presence of organic and mineral acids, basic solutions and saturated vapour is not recommended.

Rolling resistance - force / load applied

The diagram shows the force to be applied to a wheel to keep it moving at the constant speed of 4 km/h, according to the applied load.

The intersection point with a 50N value is the maximum transportable load with a manually actuated 4-wheel trolley; in fact, 200N = 50N x 4 wheels is the maximum force that may be supported by the operator according to the regulations in force regarding work safety.

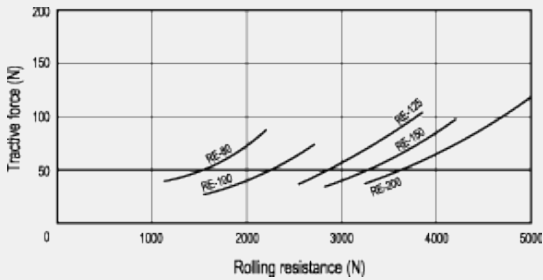



















Mechanical moving with towing devices

For mechanical towing, please see the technical specifications to determine the capacity variation.

Temperature

If operating temperatures in an application differ from the standard range of values, please see the technical specifications to determine the capacity variation.

Selection parameters		Value range	
Load capacity		Light load, up to 250 kg	●
		Medium load, up to 750 kg	●
		Heavy load, more than 750 kg	●
Rolling resistance		< 125 kg	●
		> 125 kg	●
Flooring		Tiles	●
		Asphalt	●
		Cement - resin	●
		Not paved	▲
		Expanded metal	□
		With chips, obstacles, etc.	□
Environmental chemical conditions		No aggressive chemicals	●
		With aggressive chemicals	□
Temperature		-40° / -20°	▲
		-20° / +80°	●
		+80° / +120°	□
		> 120°	▲
Means of traction		Manual	●
		Mechanical	●

- Recommended
- Tolerated
- ▲ Not recommended



Standard Elements		Main dimensions														Static load *	Rolling resistance	Dynamic carrying capacity	Weight		
Code	Description	D	d	l ₃	l ₄	H	B	L	s	b ₁	l ₁	b ₂	l ₂	b ₃	R	d ₁	d ₂	[N]	[N]	[N]	g
451501	RE.F5-080-RSL	80	12	25	30	-	-	-	-	-	-	-	-	-	-	-	-	2800	1500	2200	200
451506	RE.F5-100-RSL	100	12	30	40	-	-	-	-	-	-	-	-	-	-	-	-	3500	2250	2500	340
451511	RE.F5-125-RSL	125	12	35	40	-	-	-	-	-	-	-	-	-	-	-	-	5000	2800	4000	500
451516	RE.F5-150-RSL	150	20	40	50	-	-	-	-	-	-	-	-	-	-	-	-	8500	3300	6000	910
451521	RE.F5-200-RSL	200	25	50	55	-	-	-	-	-	-	-	-	-	-	-	-	10000	3600	8500	1450
451651	RE.F5-080-PSL	80	12	25	-	107	100	85	9	75	45	80	60	-	-	-	-	-	1500	2000	520
451656	RE.F5-100-PSL	100	12	30	-	128	100	85	9	75	45	80	60	-	-	-	-	-	2250	2000	690
451661	RE.F5-125-PSL	125	12	35	-	156	100	85	9	75	45	80	60	-	-	-	-	-	2800	2200	890
451551	RE.F5-080-SSL	80	12	25	-	107	100	85	9	75	45	80	60	39	-	-	-	-	1500	2000	720
451556	RE.F5-100-SSL	100	12	30	-	128	100	85	9	75	45	80	60	35	-	-	-	-	2250	2000	940
451561	RE.F5-125-SSL	125	12	35	-	156	100	85	9	75	45	80	60	37	-	-	-	-	2800	2200	1140
451601	RE.F5-080-SSF	80	12	25	-	107	100	85	9	75	45	80	60	39	120	-	-	-	1500	2000	910
451606	RE.F5-100-SSF	100	12	30	-	125	100	85	9	75	45	80	60	35	120	-	-	-	2250	2000	1080
451611	RE.F5-125-SSF	125	12	35	-	156	100	85	9	75	45	80	60	37	120	-	-	-	2800	2200	1280
451851	RE.F5-080-FSL	80	12	25	-	107	-	-	-	-	-	-	-	-	39	-	73	12	1500	2000	650
451856	RE.F5-100-FSL	100	12	30	-	128	-	-	-	-	-	-	-	-	35	-	73	12	2250	2000	880
451861	RE.F5-125-FSL	125	12	35	-	156	-	-	-	-	-	-	-	-	37	-	73	12	2800	2200	1080
451901	RE.F5-080-FSF	80	12	25	-	107	-	-	-	-	-	-	-	-	39	120	73	12	1500	2000	780
451906	RE.F5-100-FSF	100	12	30	-	128	-	-	-	-	-	-	-	-	35	120	73	12	2250	2000	1020
451911	RE.F5-125-FSF	125	12	35	-	156	-	-	-	-	-	-	-	-	37	120	73	12	2800	2200	1230

* The static load value is characteristic of the wheel only without motion.

Standard Elements		Main dimensions													Rolling resistance	Dynamic carrying capacity	Weight
Code	Description	D	d	l ₃	H	B	L	s	b ₁	l ₁	b ₂	l ₂	b ₃	R	[N]	[N]	g
451801	RE.F5-125-PSL-H	125	12	35	161	100	85	9	75	45	80	60	-	-	2800	3500	970
451806	RE.F5-150-PSL-H	150	20	40	200	140	114	11	105	73	105	85	-	-	3300	6000	2190
451811	RE.F5-200-PSL-H	200	25	50	250	140	114	11	105	73	105	85	-	-	3600	7500	2480
451701	RE.F5-125-SSL-H	125	12	35	161	100	85	9	75	45	80	60	48	-	2800	3500	1390
451706	RE.F5-150-SSL-H	150	20	40	200	140	110	11	105	73	105	87	70	-	3300	6000	3180
451711	RE.F5-200-SSL-H	200	25	50	250	140	110	11	105	73	105	87	70	-	3600	7500	3940
451751	RE.F5-125-SSF-H	125	12	35	161	100	85	9	75	45	80	60	48	120	2800	3500	1540
451756	RE.F5-150-SSF-H	150	20	40	200	140	110	11	105	73	105	87	70	146	3300	6000	3750
451761	RE.F5-200-SSF-H	200	25	50	250	140	110	11	105	73	105	87	70	146	3600	7500	4510



ELESA and GANTER models all rights reserved in accordance with the law. Always mention the source when reproducing our drawings.

STANDARD MACHINE ELEMENTS WORLDWIDE