





R4N

miniature industrial relays



6 A / 250 V AC

NEW

- Relays of general application • For plug-in sockets: 35 mm rail mount acc. to PN-EN 60715; on panel mounting; PCB mounting • Miniature dimensions • Cadmium - free contacts • AC and DC coils
- WT (mechanical indicator + lockable front test button) - standard features of relays. Relays may be provided with the test buttons (no latching) and plugs - page 12
- Recognitions, certifications, directives: RoHS,    

Contact data

Number and type of contacts		4 CO
Contact material		AgNi , AgNi/Au 0,2 µm, AgNi/Au 5 µm
Rated / max. switching voltage	AC	250 V / 250 V
Min. switching voltage		10 V AgNi, 10 V AgNi/Au 0,2 µm, 5 V AgNi/Au 5 µm
Rated load (capacity)	AC1	6 A / 250 V AC
	AC15	1,5 A / 120 V 0,75 A / 240 V (C300)
	AC3	125 W (single-phase motor)
	DC1	6 A / 24 V DC (see Fig. 3)
	DC13	0,22 A / 120 V 0,1 A / 250 V (R300)
Min. switching current		5 mA
Max. inrush current		12 A
Rated current		6 A
Max. breaking capacity	AC1	1 500 VA
Min. breaking capacity		0,3 W AgNi, 0,3 W AgNi/Au 0,2 µm, 0,1 W AgNi/Au 5 µm
Contact resistance		≤ 100 mΩ
Max. operating frequency		
• at rated load	AC1	1 200 cycles/hour
• no load		18 000 cycles/hour
Coil data		
Rated voltage	50/60 Hz AC	6 ... 240 V
	DC	5 ... 220 V
Must release voltage		AC: ≥ 0,2 U _n DC: ≥ 0,1 U _n
Operating range of supply voltage		see Tables 1, 2
Rated power consumption	AC	1,6 VA
	DC	0,9 W
Insulation according to PN-EN 60664-1		
Insulation rated voltage		250 V AC
Rated surge voltage		2 500 V 1,2 / 50 µs
Overvoltage category		II
Insulation pollution degree		2
Dielectric strength		
• between coil and contacts		2 500 V AC type of insulation: basic
• contact clearance		1 500 V AC type of clearance: micro-disconnection
• pole - pole		2 000 V AC type of insulation: basic
Contact - coil distance		
• clearance		≥ 1,6 mm
• creepage		≥ 3,2 mm
General data		
Operating / release time (typical values)		AC: 10 ms / 8 ms DC: 13 ms / 3 ms
Electrical life		
• resistive AC1		> 10 ⁵ 6 A, 250 V AC
• cosφ		see Fig. 2
Mechanical life (cycles)		> 2 x 10 ⁷
Dimensions (L x W x H)		27,5 x 21,2 x 35,6 mm
Weight		35 g
Ambient temperature	• storage	-40...+85 °C
	• operating	AC: -40...+55 °C DC: -40...+70 °C
Cover protection category		IP 40 PN-EN 60529
Environmental protection		RTI PN-EN 116000-3
Shock resistance	(NO/NC)	10 g / 5 g
Vibration resistance		5 g 10...150 Hz

The data in bold type pertain to the standard versions of the relays.

11.09.2013

Coil data - DC voltage version

Table 1

Coil code	Rated voltage V DC	Coil resistance at 20 °C Ω	Acceptable resistance	Coil operating range V DC	
				min. (at 20 °C)	max. (at 55 °C)
1005	5	28	± 10%	4,0	5,5
1006	6	40	± 10%	4,8	6,6
1012	12	160	± 10%	9,6	13,2
1024	24	640	± 10%	19,2	26,4
1048	48	2 600	± 10%	38,4	52,8
1060	60	4 000	± 10%	48,0	66,0
1080	80	7 100	± 10%	64,0	88,0
1110	110	13 600	± 10%	88,0	121,0
1125	125	16 000	± 10%	100,0	137,5
1220	220	54 000	± 10%	176,0	242,0

The data in bold type pertain to the standard versions of the relays.

Coil data - AC 50/60 Hz voltage version

Table 2

Coil code	Rated voltage V AC	Coil resistance at 20 °C Ω	Acceptable resistance	Coil operating range V AC	
				min. (at 20 °C)	max. (at 55 °C)
5006	6	9,8	± 10%	4,8	6,6
5012	12	39,5	± 10%	9,6	13,2
5024	24	158	± 10%	19,2	26,4
5042	42	470	± 10%	33,6	46,2
5048	48	640	± 10%	38,4	52,8
5060	60	930	± 10%	48,0	66,0
5080	80	1 720	± 10%	64,0	88,0
5110	110	3 450	± 10%	88,0	121,0
5115	115	3 610	± 10%	92,0	127,0
5120	120	3 770	± 10%	96,0	132,0
5127	127	4 000	± 10%	101,6	139,0
5220	220	15 400	± 10%	176,0	242,0
5230	230	16 100	± 10%	184,0	253,0
5240	240	16 800	± 10%	192,0	264,0

The data in bold type pertain to the standard versions of the relays.

NEW TECHNOLOGY

The new R2N, R3N, R4N relays are modernized versions of the R2, R3, R4 relays. The modernization covered the design of the relays and the manufacturing process.



R4N

miniature industrial relays

Dimensions - plug-in version (WT), with lockable front test button type T

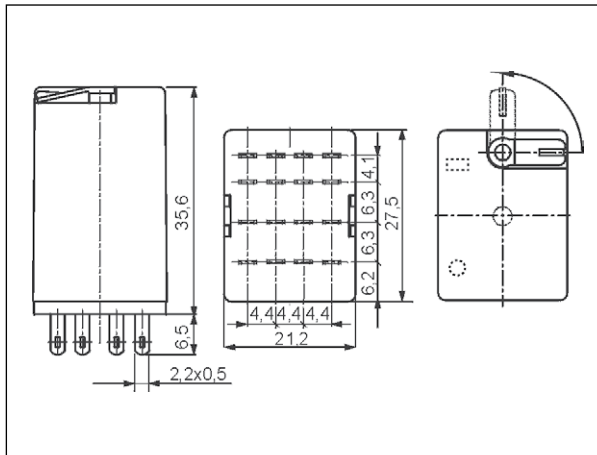

Dimensions - plug-in version, with test button (no latching) or with plug (no manual operation)

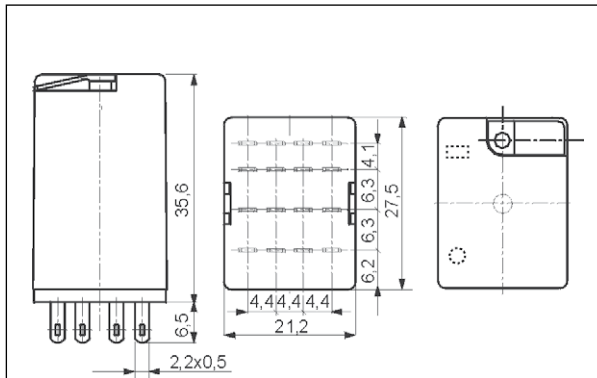

Test buttons R4P-0001 and plugs R4W-0003 need to be ordered separately. They substitute buttons type T. To exchange by Customer themselves. Information on test buttons (no latching) and plugs - page 12.

Connection diagram (pin side view)

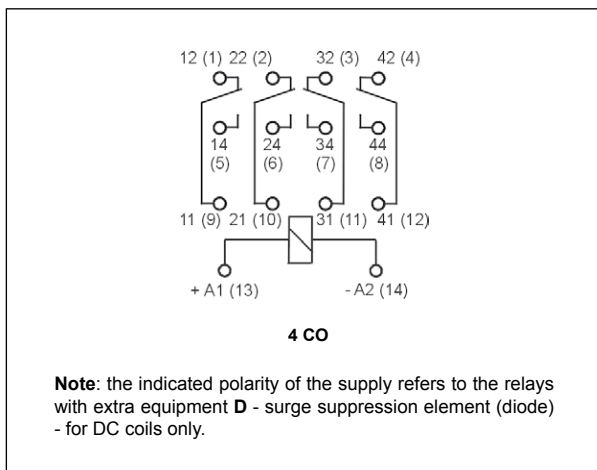

Design



Improvement of the functionality of the mechanical indicator (W): it is mounted on an insulation base of the unit of the movable contacts; the changes provide the appropriate position in the window in the upper side of the housing irrespectively of the number of operations performed by the relay.

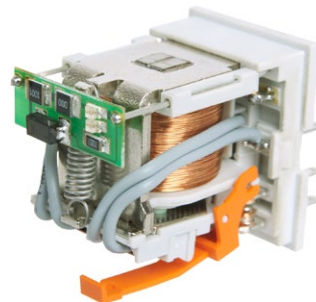

Application of electronics made in the SMD technology: additional features L (LED diode) and D (diode) are located on the printed circuit board; the change of the position of the LED diode and optimization of the quality and intensity of its light provide certainty that the relay is in operation status when the LED is on.



Improvement of the efficiency of the electromagnet: an innovational technology of connecting elements has been introduced, which guarantees more reliable operation of the relay.

Strengthening of the insulation in the area of the contact plate: polyamide PA66 has been applied; it has very good mechanical and electrical parameters and best thermal properties.

Electrical life at AC resistive load.
Switching frequency: 1 200 cycles/hour

Fig. 1

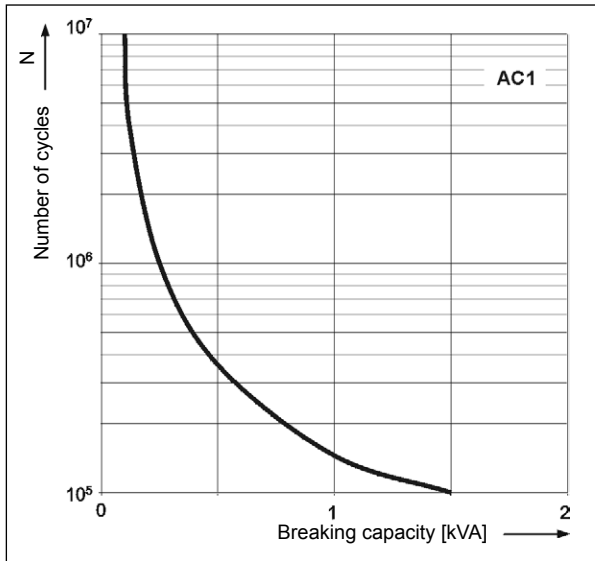

Electrical life reduction factor at AC inductive load

Fig. 2

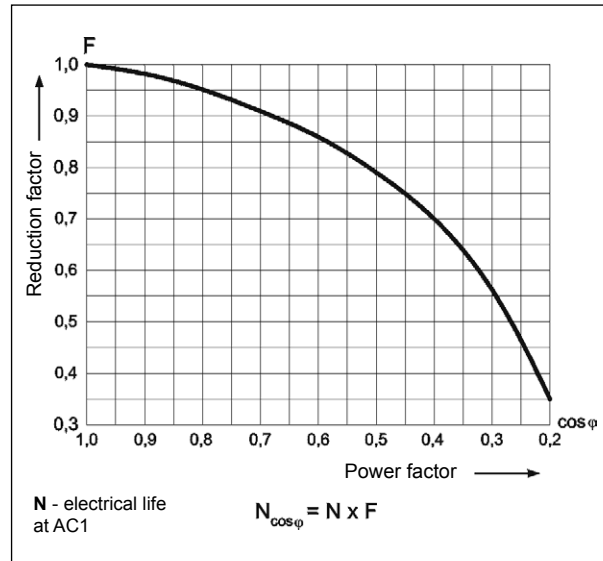

Max. DC breaking capacity
A - resistive load DC1
B - inductive load L/R = 40 ms

Fig. 3

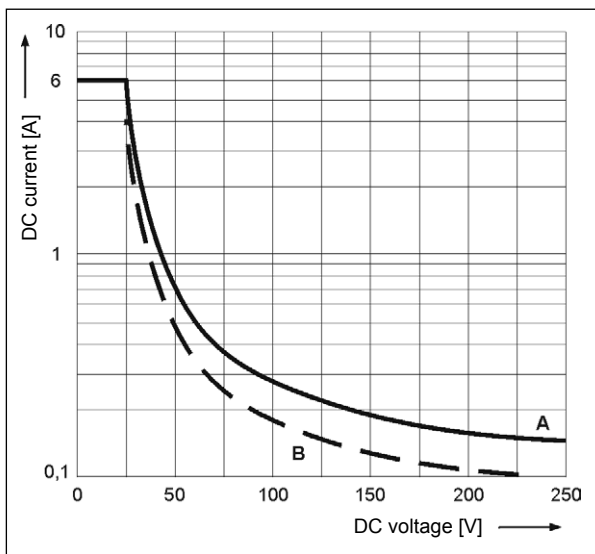

Contact material selection for different load types

- **AgNi** - for resistive or inductive loads,
- **AgNi/Au 0,2 μm** - Au protects the contact surface during storage,
- **AgNi/Au 5 μm** - for small resistive loads in control circuits.

Mounting

Relays **R4N** are designed for mounting in plug-in sockets, **with WT features as standard** (**W** - mechanical indicator + **T** - lockable front test button). In these relays is **possibility self-exchange of button type T for test button R4P-0001** (no latching) **or on plug R4W-0003** (no manual operation). The buttons **R4P-0001** and the plugs **R4W-0003** **need to ordered separately**.

Relays **R4N** are designed for:

- screw terminals plug-in sockets **GZT4** and **GZM4** with clip **GZT4-0040** or **G4 1052**, 35 mm rail mount acc. to PN-EN 60715 or on panel mounting with two M3 screws
- spring terminals plug-in sockets **GZMB4** with clip **GZMB4-0040** or **G4 1052**, 35 mm rail mount acc. to PN-EN 60715. Signalling / protecting modules **type M...** are available with sockets (see page 9)
- screw terminals plug-in sockets **GZ4** with clip **G4 1052** or plug-in sockets **GS4** with clip **GS4-0036**, 35 mm rail mount acc. to PN-EN 60715 or on panel mounting with two M3 screws
- plug-in sockets for PCB mounting **SU4D** with clip **G4 1053**
- solder terminals sockets **SU4L** with clip **G4 1053** and spring clamp **G4 1040**
- solder terminals sockets **G4** with clip **G4 1053**.

① Plug-in sockets **GZT4**, **GZM4** may be linked with interconnection strip type **ZGGZ4** (see page 10).

② For sockets **GZMB4** - see page 7 (wire connection).

Ordering codes

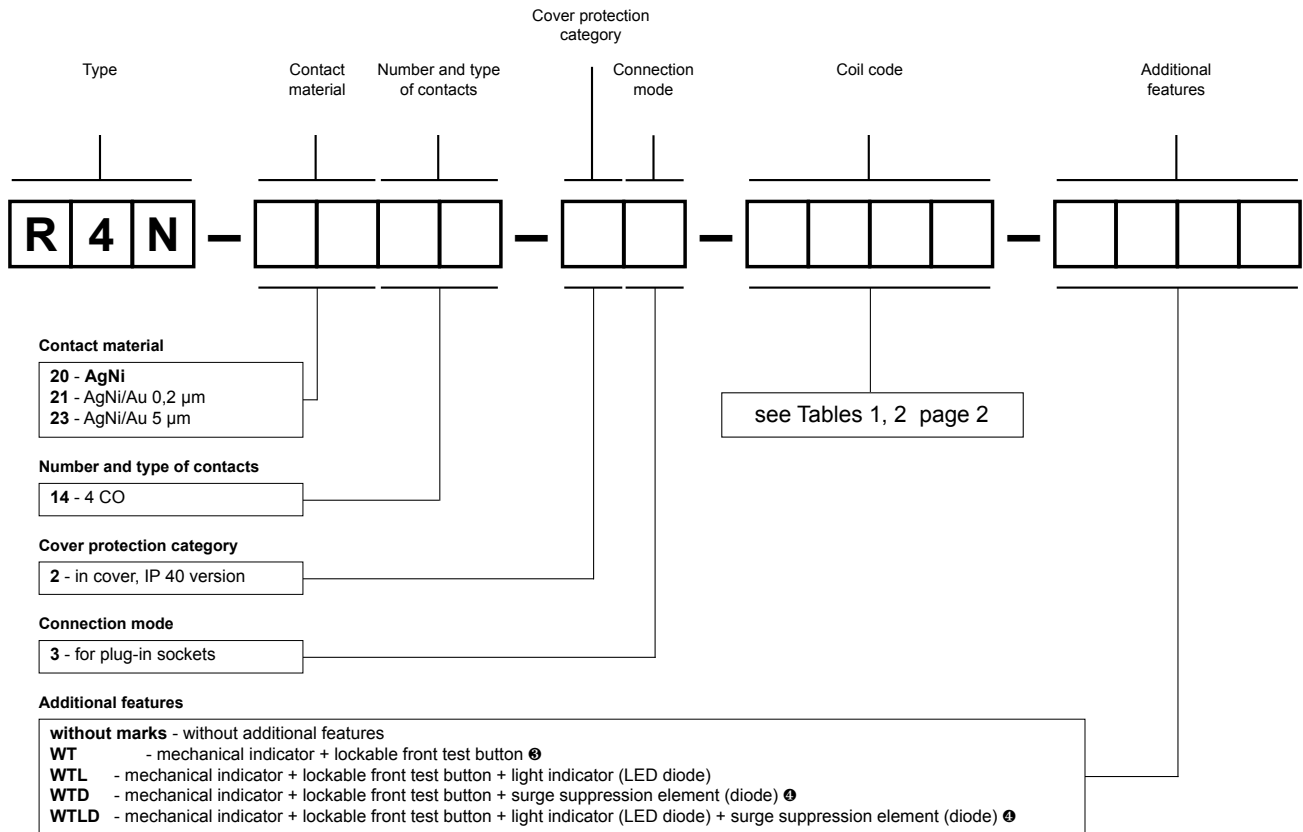

③ WT - standard features of relays

④ WTD, WTLD - available only in relays with DC coils

Test buttons (no latching) and plugs need to ordered separately. They substitute buttons type T. To exchange by Customer themselves. Information on test buttons (no latching) and plugs - page 12.

- Button R4P-0001-A - orange colour (AC coils)
- Button R4P-0001-D - green colour (DC coils)
- Plug R4W-0003-A - orange colour (AC coils)
- Plug R4W-0003-D - green colour (DC coils)

Note:

For relays with additional features **D** - surge suppression element (diode) (versions WTD and WTLD) - fixed supply polarity compulsory for the DC load of coils: +A1(13) / -A2(14). The polarity is indicated on the relay cover. For other versions of the relays with DC coils any polarity is possible.

Example of ordering code:

R4N-2014-23-5230-WTL relay **R4N**, for plug-in sockets, four changeover contacts, contact material AgNi, coil voltage 230 V AC 50/60 Hz, with mechanical indicator and lockable front test button and light indicator (LED diode), in cover IP 40

Plug-in sockets and accessories

GZT4 ③

For R4, R4N, T-R4

Screw terminals
Max. tightening moment for the terminal: 0,7 Nm
35 mm rail mount
acc. to PN-EN 60715
or on panel mounting
76,3 x 27 x 42,5(80) mm ②
Four poles
6 A, 300 V AC



Connection diagram

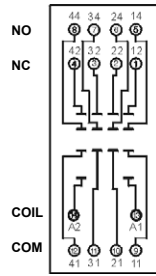

Dimensions

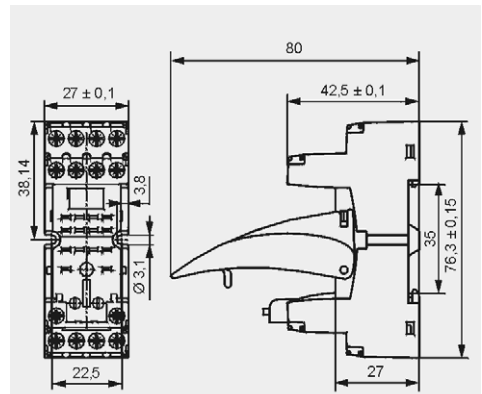

Accessories ① ④

GZT4-0035 Module type M...

GZM4

For R4, R4N, T-R4

Screw terminals
Max. tightening moment for the terminal: 0,7 Nm
35 mm rail mount
acc. to PN-EN 60715
or on panel mounting
75 x 27 x 61(82) mm ②
Four poles
6 A, 300 V AC



Connection diagram

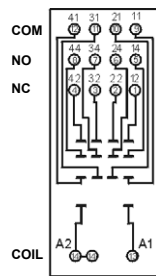

Dimensions

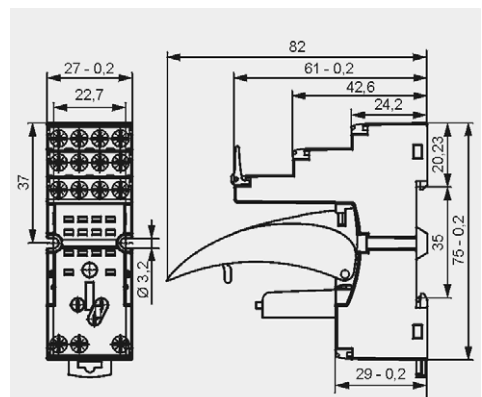

Accessories ① ④

GZT4-0035 Module type M...

GZ4

For R4, R4N

Screw terminals
Max. tightening moment for the terminal: 0,7 Nm
35 mm rail mount
acc. to PN-EN 60715
or on panel mounting
66,4 x 29,5 x 29 mm
Four poles
10 A, 300 V AC



Connection diagram

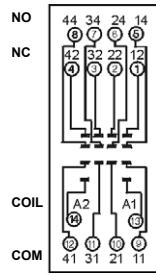

Dimensions

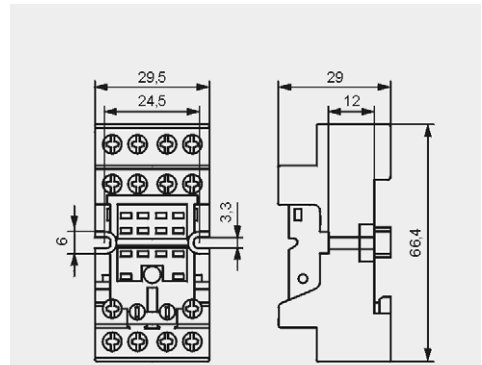

Accessories

G4 1052

GS4

For R4, R4N

Screw terminals
Max. tightening moment for the terminal: 0,7 Nm
35 mm rail mount
acc. to PN-EN 60715
or on panel mounting
67 x 30,8 x 30(~63,7) mm ⑤
Four poles
6 A, 300 V AC



Connection diagram

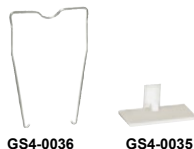
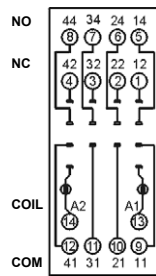

Dimensions

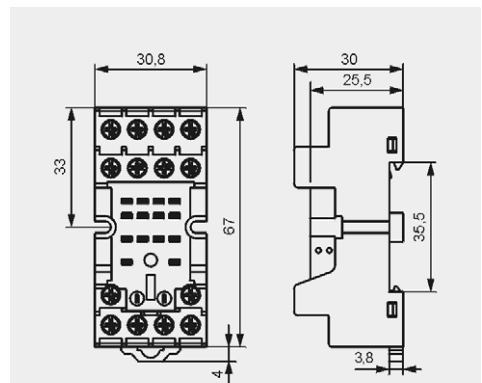

Accessories

GS4-0036 GS4-0035

① Mounting and sub-assemblies of accessories in the socket - see page 7. Signalling / protecting modules type M... - see page 9. ② In the bracket the height of socket with retainer / retractor clip is shown. ③ Have obtained LR Type Approval Certificate (Lloyd's Register). ④ For R4, R4N relays: G4 1052, GZT4-0040, GZMB-0040, GZT4-0035, TR, module type M...; for T-R4 relays: TR4-2000, GZT4-0035, TR ⑤ In the bracket the height of socket with spring wire clip is shown.

Plug-in sockets and accessories

GZMB4

For R4, R4N, T-R4

Spring terminals

Max. cross section of the cables:
1 x 0,2...1,5 mm²
(1 x 24...16 AWG)

Length of the cable deinsulation:
9...11 mm

35 mm rail mount

acc. to PN-EN 60715

95 x 31 x 42,5(80) mm

Four poles

10 A, 300 V AC

Connection diagram

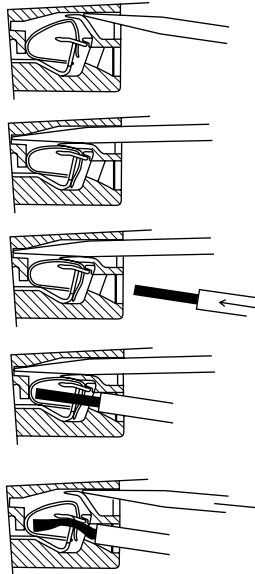
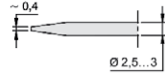
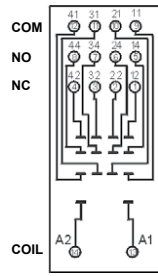

Dimensions

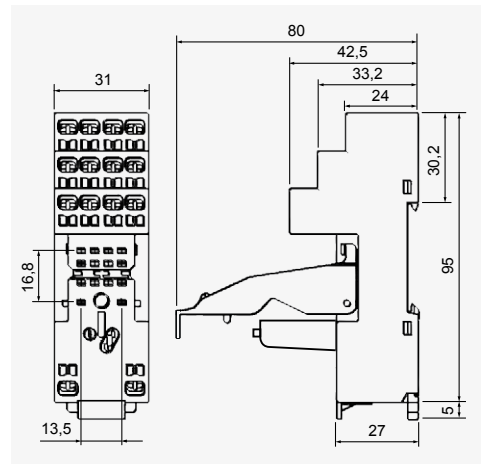

The drawings present the sequence of operations in course of inserting wires to the spring terminal, and the recommended screwdriver to be used for opening of case springs, comply with the DIN 5264 FORM „A”.



GZMB4-0040



TR



Module type M...



G4 1052



TR4-2000

Accessories 1 4

Wire connection

1 Mounting and sub-assemblies of accessories in the socket - see page 7. Signalling / protecting modules type M... - see page 9. 2 In the bracket the height of socket with retainer / retractor clip is shown. 3 For R4, R4N relays: G4 1052, GZT4-0040, GZMB-0040, GZT4-0035, TR, module type M...; for T-R4 relays: TR4-2000, GZT4-0035, TR

Mounting and sub-assemblies of the relay and accessories in the socket

Signalling / protecting module type M...

Electromagnetic relay

Retainer / retractor clip

Removing the relay from the socket with a retainer / retractor clip

Screw terminals plug-in socket

Description plate

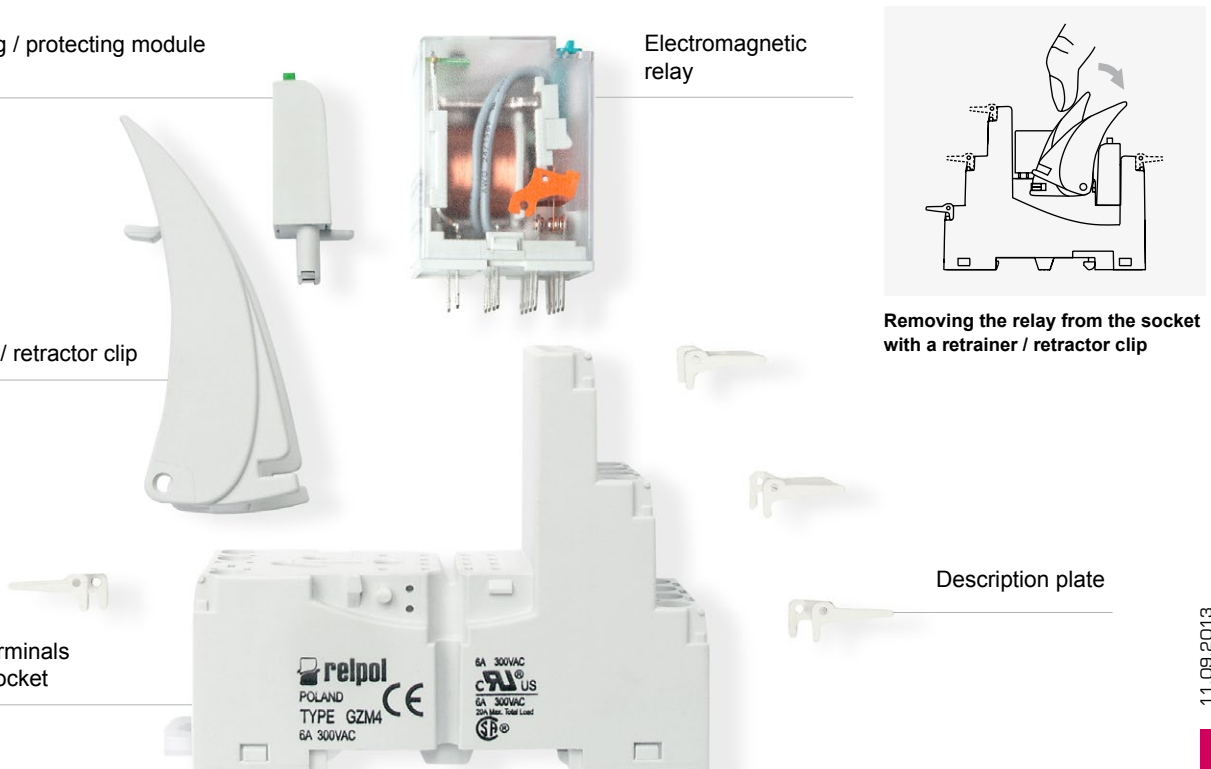

11.09.2013

Plug-in sockets and accessories

SU4D

For R4, R4N

For PCB
29,6 x 21,5 x 11 mm
Four poles
6 A, 250 V AC

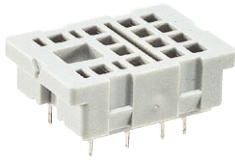

Pinout

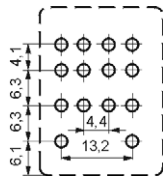

G4 1053

Dimensions

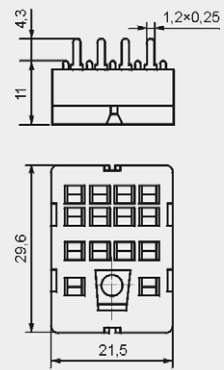

Accessories

SU4L

For R4, R4N

Solder terminals
29,6 x 21,5 x 18,1 mm
Four poles
6 A, 250 V AC



Dimensions of opening on panel mounting

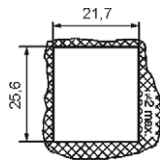

G4 1053



G4 1040

Dimensions

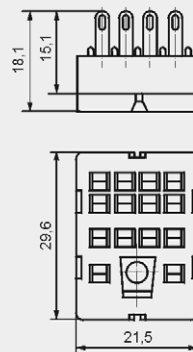

Accessories

G4

For R4, R4N

Solder terminals
40,5 x 21,5 x 18,1 mm
Four poles
6 A, 250 V AC

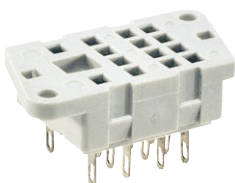

Pinout of openings on panel mounting

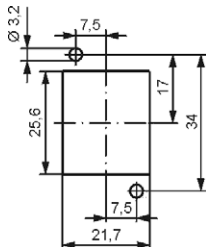

G4 1053

Dimensions

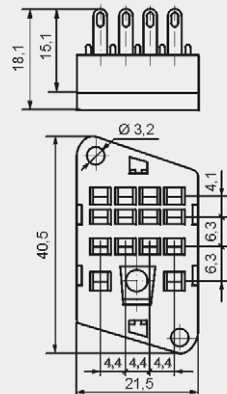

Accessories

PRECAUTIONS:

1. Ensure that the parameters of the product described in its specification provide a safety margin for the appropriate operation of the device or system and never use the product in circumstances which exceed the parameters of the product. 2. Never touch any live parts of the device. 3. Ensure that the product has been connected correctly. An incorrect connection may cause malfunction, excessive heating or risk of fire. 4. In case of any risk of any serious material loss or death or injuries of humans or animals, the devices or systems shall be designed so to equip them with double safety system to guarantee their reliable operation.

Signalling / protecting modules type M...

For sockets type:

GZT80, GZM80, GZS80, GZMB80, GZT92, GZM92, GZS92, ES 32, GZT2, GZM2, GZMB2, GZT3, GZM3, GZT4, GZM4, GZMB4

Modules type M... are parallelly connected with relay coil.

Polarity P: -A1/+A2. Polarity N: +A1/-A2.

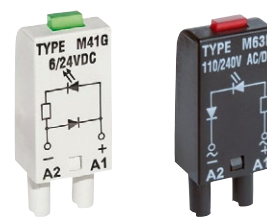

Modules type M...	Layout	Voltage	Type of module ① ②
Module D (polarization P) It limits overvoltage on DC coils.		6/230 V DC	M21P
Module D (polarization N) It limits overvoltage on DC coils.		6/230 V DC	M21N
Module LD (polarization P) It limits overvoltage on DC coils. Coil energizing indication.		6/24 V DC 24/60 V DC 110/230 V DC	M31R, M31G M32R, M32G M33R, M33G
Module LD (polarization N) It limits overvoltage on DC coils. Coil energizing indication.		6/24 V DC 24/60 V DC 110/230 V DC	M41R, M41G M42R, M42G M43R, M43G
Module RC It protects against EMC disturbance. It limits overvoltage.		6/24 V AC 24/60 V AC 110/240 V AC	M51 M52 M53
Module L Coil energizing indication.		6/24 V AC/DC 24/60 V AC/DC 110/230 V AC/DC	M61R, M61G M62R, M62G M63R, M63G
Module LV It limits overvoltage on AC and DC coils. Coil energizing indication.		6/24 V AC/DC 24/60 V AC/DC 110/230 V AC/DC	M91R, M91G M92R, M92G M93R, M93G
Module V It limits overvoltage on AC and DC coils. No indication.		24 V AC 130 V AC 230 V AC	M71 M72 M73
Module R It limits overvoltage on AC coils.		110/230 V AC	M103

① M...R - LED red, M...G - LED green

② When ordering modules indicate their color: gray or black.

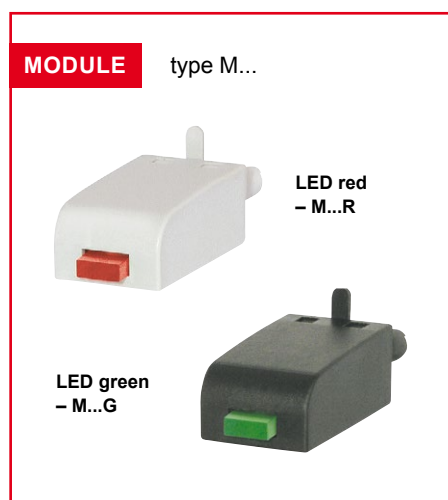

Interconnection strips ZGGZ4



GZM2 + R2N...WT

ZGGZ4

ZGGZ4 for:

Plug-in sockets	Relays for plug-in sockets	Interface relays [⊕]
GZT2	R2...WT, R2N...WT	PIR2-...-00L. (GZM2 + R2...WT)
GZM2		PIR3-...-00L. (GZM3 + R3...WT)
GZT3	R3...WT, R3N...WT	PIR4-...-00L. (GZM4 + R4...WT)
GZM3		
GZT4	R4...WT, R4N...WT	
GZM4		

[⊕] Interface relay **PIR2** (**PIR3**, **PIR4**) is offered as a **set**: plug-in socket **GZM2** (**GZM3**, **GZM4**) + miniature industrial relay **R2** (**R3**, **R4**) + signalling / protecting module **type M...** + retainer / retractor clip **GZT4-0040** + description plate **GZT4-0035**.



Interconnection strip ZGGZ4

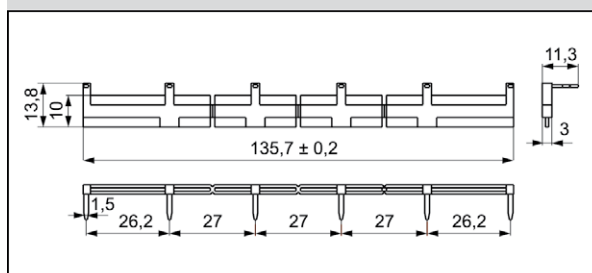
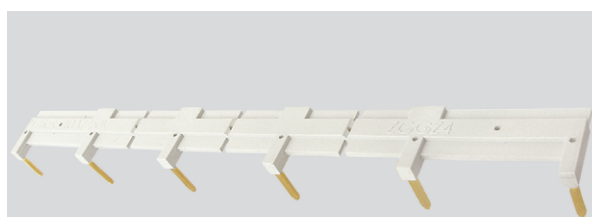





- designed for the co-operation with plug-in sockets of miniature industrial relays and with interface relays PIR2, PIR3 and PIR4, which are equipped with screw terminals; sockets and relays are mounted on 35 mm rail mount acc. to PN-EN 60715,
- bridges common input signals (coil terminals A1 or A2) or output signals - see photo at the top,
- maximum permissible current is 10 A / 250 V AC,
- possibility of connection of 6 sockets or relays,
- colours of strips: **ZGGZ4-1** grey, **ZGGZ4-2** black.



11.09.2013

Additional features for industrial relays

Industrial relays for plug-in sockets: R2, R2N, R3, R3N, R4, R4N, R15 - 2 CO , R15 - 3 CO  with **WT features as standard** (**W** - mechanical indicator + **T** - lockable front test button). **Detailed information** on additional features of individual relays can be found in the data sheets on the side of "Ordering codes".

Type 	Description	For industrial relays
W	mechanical indicator	R2, R2N, R3, R3N, R4, R4N, (R15 - 2 CO, 3 CO )
T	lockable front test button, orange colour - AC coils, green colour - DC coils	R2, R2N, R3, R3N, R4, R4N, (R15 - 2 CO, 3 CO )
L	light indicator (LED diode), located inside the relay	R2, R2N, R3, R3N, R4, R4N, RY2, (R15 - 2 CO, 3 CO, 4 CO ) RUC, RUC-M
D	surge suppression element (diode) - only for DC coils	R2, R2N, R3, R3N, R4, R4N, RY2, (R15 - 2 CO, 3 CO, 4 CO )
V	surge suppression element (varistor) - only for AC coils	(R15 - 2 CO, 3 CO )
K	test button without block function	(R15 - 4 CO ), RUC

 Available combinations:

WT, WTL, WTD, WTL D - in relays R2, R2N, R3, R3N, R4, R4N for plug-in sockets

L, D, LD - in relays RY2 for plug-in sockets

WT, WTL, WTD, WTL D, WTV, WTL V - in relays R15 - 2 CO, 3 CO for plug-in sockets

K, L, D, KL, KD, LD, KLD - in relays R15 - 4 CO for plug-in sockets

K, L, KL - in relays RUC

L - in relays RUC-M

 Voltage versions, in cover

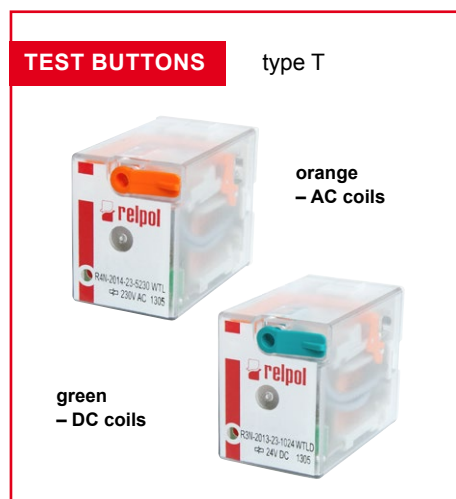

Test buttons (no latching) and plugs

Test buttons (no latching) are recommended for R2...WT, R2N...WT, R3...WT, R3N...WT, R4...WT, R4N...WT, R15...WT 2 CO, R15...WT 3 CO relays - **for applications that do not allow permanent contact latching**. By manual operation (pressing the button) relay contacts can get switched for as long time as long the button is pressed. Contacts return to initial position as soon as pressure is released from the button. Those operations can be done while the coil is deenergized.

Button **R4P-0001** or **R15-M404** can be easily inserted by the Customer after removal of button type **T** (see Fig. 2). Button type **T** can be removed with screwdriver as shown on Fig. 1.

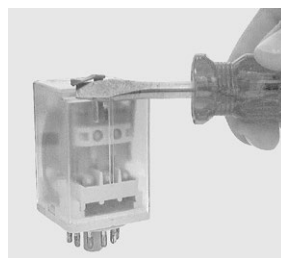

Fig. 1

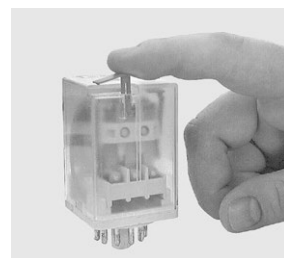
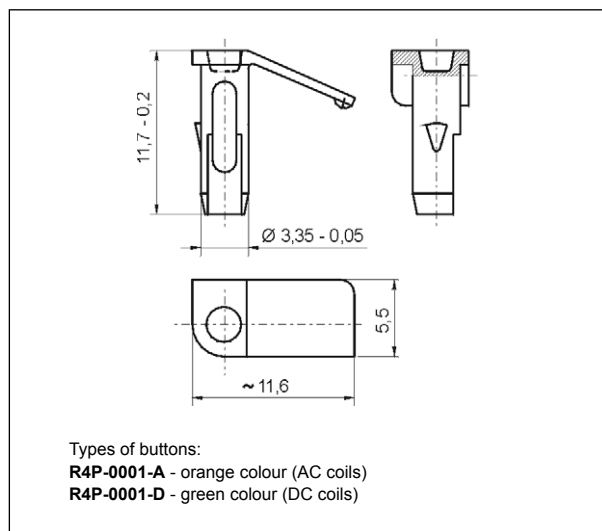
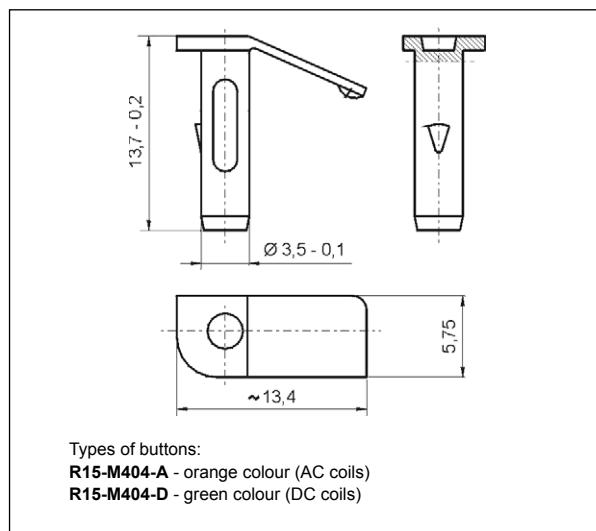

Fig. 2

Dimensions - test button R4P-0001 for R2...WT, R2N...WT, R3...WT, R3N...WT, R4...WT, R4N...WT



Dimensions - test button R15-M404 for R15...WT 2 CO, R15...WT 3 CO



Plugs R4W-0003 or **R15-M203** can substitute button type **T** if **manual operation (latching and testing) is not allowed**. Changing button type **T** for plug can be done by Customer themselves in the same way as changing button type **T** for button (no latching).

Dimensions - plug R4W-0003 for R2...WT, R2N...WT, R3...WT, R3N...WT, R4...WT, R4N...WT

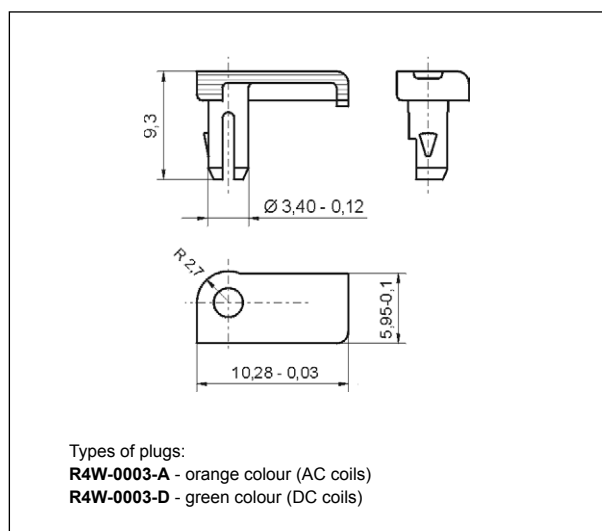

Dimensions - plug R15-M203 for R15...WT 2 CO, R15...WT 3 CO

