



Features:

- No UV or IR light radiation.
- Provide 120° beam angles.
- Easy Installation:
- Very Low Power Consumption:
Less than 6 Watts/m
- Long lifetime: 25000 hours (L₇₀).
- High CRI: 70-85
- Correlated Color Temperature: 2700-12000K
- Operating temperature: -20°C ~ +60°C
- 12V DC input.
- 60 leds per meter, 5 meter per roll, each 3 leds as one series, each series can be cutted.
- LED type: 3014 LED
- Waterproof grade :IP65

Benefits:

- Energy Cost Savings:
Over 60% Compared to Incandescent.
- Solid-State:
High-Shock & High-Vibration Resistant,
Both Electrical and Mechanical
- Eco-Friendly:
No Mercury, No Lead Content
- No Hazardous Emissions:
No UV or IR Radiation
- Constant Light Output:
Even Lighting, Non-Halation

Application:

- Advertisement signboard lighting
- Exhibition stand lighting
- Showcase lighting
- Jewelry lighting
- Club lighting
- Bar lighting

Product Specifications:

Input Voltage	12V DC
Wattage	6W/m
Operating Frequency	50-60Hz
Operating Temperature	-20°C ∞ +60°C
Storage Temperature	-30°C ∞ +70°C
Net Weight per piece (Kg)	---
Certification	RoHS Compliant

Product Selection Guide:

Product	Beam Angle	Total Lumens	CCT	Color	CRI
LS-3014WW60RN2	120°	550±5%	2700-3200K	Warm White	≥ 70
LS-3014W60RN2	120°	600±5%	6000-6500K	White	≥ 70

LS-/3014/XX/60/RN/2

① ② ③ ④ ⑤ ⑥

- ① LS: Light Strip light
- ② 3014: 3014 LED type
- ③ XX: WW(Warm White) W(White)
- ④ 60: 60 pcs of LED
- ⑤ RN: DC 12V input
- ⑥ 2: Waterproof grade :IP65

Product Dimensions:

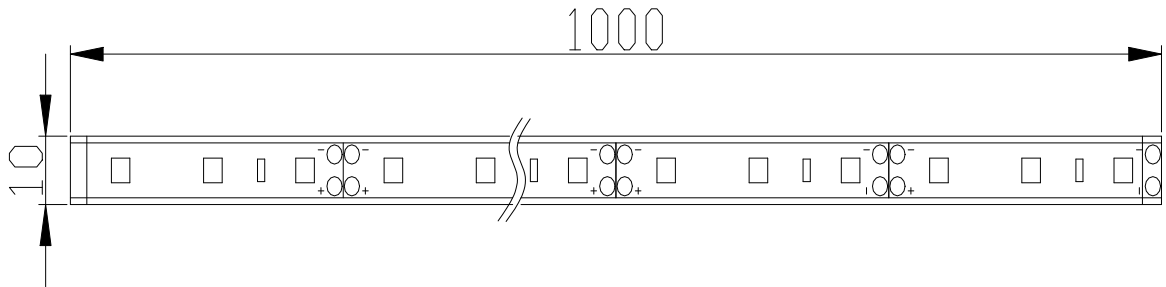

Notes:

1. All dimensions unit in mm
2. Tolerances is ± 1 mm unless otherwise noted.

Package Dimension

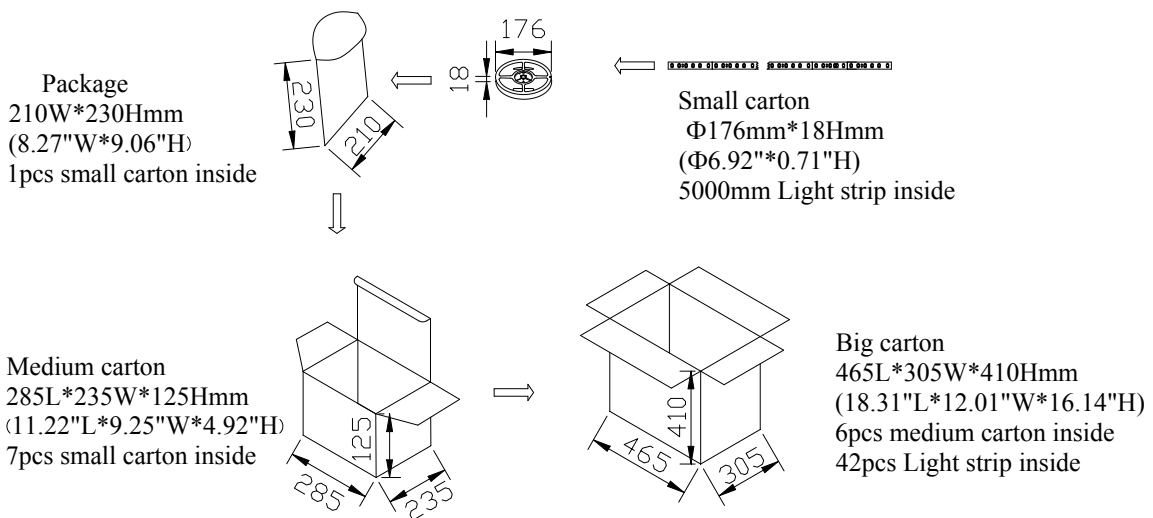

Installation Instructions and Warnings:

- Turn off power before inspection, installation, or removal.
- Not for use where exposed to the weather
- Do not use in totally enclosed fixtures.
- Not for use with dimmers.
- Please make sure to use a suitable adapter. Please mind the minimum load of your adapter.
- 5A adapter (May actuate 10 meter lamp strip):

Adapter Input Voltage: AC100-240V

Adapter Output Voltage: DC12V

Operation Range: 90 – 264VAC

The maximum input current is measured at maximum load: 0.5A@ 100~240VAC