

# LP2985-N Micropower 150-mA Low-Noise Ultra-Low-Dropout Regulator in SOT-23 and DSBGA Packages Designed for Use with Very Low ESR Output Capacitors

## 1 Features

- Input Voltage Range: 2.5 V to 16 V
- Ultra Low-Dropout Voltage
- Ensured 150 mA Output Current
- Smallest Possible Size (SOT-23 and DSBGA 0.5-mm Pitch Packages)
- Requires Minimum External Components
- Stable With Low-ESR Output Capacitor
- < 1  $\mu$ A Quiescent Current When Shut Down
- Low Ground Pin Current at All Loads
- Output Voltage Accuracy 1% (A Grade)
- High Peak Current Capability
- Low  $Z_{OUT}$ : 0.3  $\Omega$  Typical (10 Hz to 1 MHz)
- Overtemperature and Overcurrent Protection
- $-40^{\circ}\text{C}$  to  $125^{\circ}\text{C}$  Junction Temperature Range
- Custom Voltages Available

## 2 Applications

- Cellular Phone
- Palmtop and Laptop Computer
- Personal Digital Assistant (PDA)
- Camcorder, Personal Stereo, Camera

## 3 Description

The LP2985-N low noise linear regulator delivers up to 150-mA output current and only requires 300-mV dropout voltage of input to output. Using an optimized VIP (Vertically Integrated PNP) process, the LP2985-N delivers unequaled performance for all battery-powered designs. The LP2985-N device provides 1% tolerance precision output voltage with only 75  $\mu$ A quiescent current at 1 mA load and 850  $\mu$ A at 150 mA load. By adding a 10-nF bypass capacitor, the output noise can be reduced to 30  $\mu\text{V}_{\text{RMS}}$  in a 30-kHz bandwidth.

The LP2985-N is designed to work with a ceramic output capacitor with equivalent series resistance (ESR) as low as 5 m $\Omega$ . The devices are available with fixed output voltage from 2.5 V to 6.1 V. Contact Texas Instrument Sales for specific voltage option needs.

The smallest SOT-23 and DSBGA packages are available for absolute minimum board space.

### Device Information<sup>(1)</sup>

| PART NUMBER | PACKAGE    | BODY SIZE                 |
|-------------|------------|---------------------------|
| LP2985-N    | SOT-23 (5) | 2.90 mm x 1.60 mm (NOM)   |
|             | DSBGA (5)  | 1.159 mm x 0.981 mm (MAX) |
|             |            | 1.464 mm x 1.095 mm (MAX) |

(1) For all available packages, see the orderable addendum at the end of the datasheet.

### Simplified Schematic

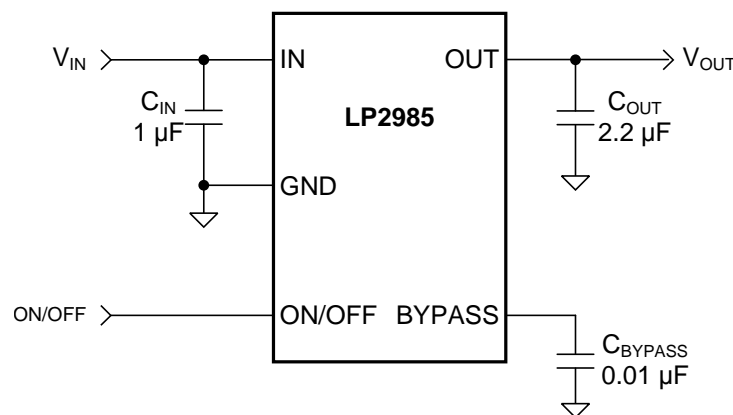

## Table of Contents

|  |           |  |           |
|--|-----------|--|-----------|
| <b>1 Features</b> .....                        | <b>1</b>  | 8.4 Device Functional Modes.....                                 | <b>13</b> |
| <b>2 Applications</b> .....                    | <b>1</b>  | <b>9 Application and Implementation</b> .....                    | <b>15</b> |
| <b>3 Description</b> .....                     | <b>1</b>  | 9.1 Application Information.....                                 | <b>15</b> |
| <b>4 Revision History</b> .....                | <b>2</b>  | 9.2 Typical Application .....                                    | <b>15</b> |
| <b>5 Device Comparison Table</b> .....         | <b>3</b>  | <b>10 Power Supply Recommendations</b> .....                     | <b>22</b> |
| <b>6 Pin Configuration and Functions</b> ..... | <b>4</b>  | <b>11 Layout</b> .....   | <b>22</b> |
| <b>7 Specifications</b> .....                  | <b>5</b>  | 11.1 Layout Guidelines .....                                     | <b>22</b> |
| 7.1 Absolute Maximum Ratings .....             | <b>5</b>  | 11.2 Layout Example .....  | <b>22</b> |
| 7.2 ESD Ratings.....                           | <b>5</b>  | 11.3 DSBGA Mounting.....   | <b>22</b> |
| 7.3 Recommended Operating Conditions.....      | <b>5</b>  | 11.4 DSBGA Light Sensitivity .....                               | <b>23</b> |
| 7.4 Thermal Information .....                  | <b>6</b>  | <b>12 Device and Documentation Support</b> .....                 | <b>24</b> |
| 7.5 Electrical Characteristics.....            | <b>6</b>  | 12.1 Documentation Support .....                                 | <b>24</b> |
| 7.6 Typical Characteristics .....              | <b>8</b>  | 12.2 Community Resources.....                                    | <b>24</b> |
| <b>8 Detailed Description</b> .....            | <b>12</b> | 12.3 Trademarks .....  | <b>24</b> |
| 8.1 Overview .....                             | <b>12</b> | 12.4 Electrostatic Discharge Caution.....                        | <b>24</b> |
| 8.2 Functional Block Diagram .....             | <b>12</b> | 12.5 Glossary .....  | <b>24</b> |
| 8.3 Feature Description.....                   | <b>12</b> | <b>13 Mechanical, Packaging, and Orderable Information</b> ..... | <b>24</b> |

## 4 Revision History

NOTE: Page numbers for previous revisions may differ from page numbers in the current version.

| <b>Changes from Revision W (September 2014) to Revision X</b>  | <b>Page</b> |
|--|-------------|
| • Changed pin names in text and app circuit drawing "VOUT" and "VIN" to "OUT" and "IN"; replace <i>Handling Ratings</i> with <i>ESD Ratings</i> ; update <i>Thermal Values</i> ..... | <b>1</b>    |
| • Changed footnote 1 to <i>Ab Max</i> table per new format .....   | <b>5</b>    |
| • Changed location of storage temperature range from <i>Handling Ratings</i> to <i>Ab Max</i> table.....   | <b>5</b>    |
| • Added required <i>Application Information</i> section .....  | <b>15</b>   |

| <b>Changes from Revision V (April 2013) to Revision W</b>  | <b>Page</b> |
|--|-------------|
| • Added <i>Pin Configuration and Functions</i> section, <i>Handling Rating</i> table, <i>Feature Description</i> section, <i>Device Functional Modes</i> , <i>Application and Implementation</i> section, <i>Power Supply Recommendations</i> section, <i>Layout</i> section, <i>Device and Documentation Support</i> section, and <i>Mechanical, Packaging, and Orderable Information</i> section ..... | <b>1</b>    |

| <b>Changes from Revision U (April 2013) to Revision V</b>  | <b>Page</b> |
|--|-------------|
| • Changed layout of National Data Sheet to TI format ..... | <b>23</b>   |

## 5 Device Comparison Table

| DEVICE NUMBER | PACKAGE     | VOLTAGE OPTION (V) |
|---------------|-------------|--------------------|
| LP2985-N      | SOT-23      | 2.5                |
|               |             | 2.6                |
|               |             | 2.7                |
|               |             | 2.8                |
|               |             | 2.9                |
|               |             | 3.0                |
|               |             | 3.1                |
|               |             | 3.2                |
|               |             | 3.3                |
|               |             | 3.6                |
|               |             | 3.8                |
|               |             | 4.0                |
|               |             | 4.5                |
|               |             | 5.0                |
|               | 5.7         |                    |
|               | 6.1         |                    |
|               | DSBGA (YPB) | 2.5                |
|               |             | 2.6                |
|               |             | 2.7                |
|               |             | 2.8                |
|               |             | 2.9                |
| DSBGA (YZR)   | 3.0         |                    |
|               | 3.3         |                    |
|               | 5.0         |                    |
|               | DSBGA (YZR) | 3.3                |

## 6 Pin Configuration and Functions

**DBV Package  
5 Pin SOT-23  
Top View**

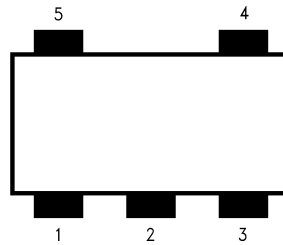

**YPB and YZR Packages  
5-Pin DSBGA  
Top View**

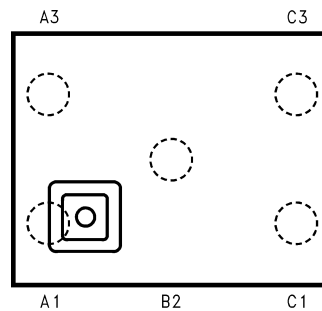

**Pin Functions**

| NAME   | PIN    |       | TYPE | DESCRIPTION                              |
|--------|--------|-------|------|--|
|        | SOT-23 | DSBGA |      |  |
| IN     | 1      | C3    | I    | Input voltage                            |
| GND    | 2      | A1    | —    | Common ground (device substrate)         |
| ON/OFF | 3      | A3    | I    | Logic high enable input                  |
| BYPASS | 4      | B2    | I/O  | Bypass capacitor for low noise operation |
| OUT    | 5      | C1    | O    | Regulated output voltage                 |

## 7 Specifications

### 7.1 Absolute Maximum Ratings

over operating free-air temperature range (unless otherwise noted)<sup>(1)(2)</sup>

|  | MIN                     | MAX | UNIT |
|--|-------------------------|-----|------|
| Operating junction temperature                       | –40                     | 125 | °C   |
| Lead Temp. (Soldering, 5 sec.)                       |                         | 260 | °C   |
| Power dissipation <sup>(3)</sup>                     | Internally Limited      |     |      |
| Input supply voltage (survival)                      | –0.3                    | 16  | V    |
| Input supply voltage (operating)                     | 2.5                     | 16  | V    |
| Shutdown input voltage (survival)                    | –0.3                    | 16  | V    |
| Output voltage (survival, See <sup>(4)</sup> )       | –0.3                    | 9   | V    |
| I <sub>OUT</sub> (survival)                          | Short Circuit Protected |     |      |
| Input-output voltage (survival, see <sup>(5)</sup> ) | –0.3                    | 16  | V    |
| Storage temperature, T <sub>stg</sub>                | –65                     | 150 | °C   |

- (1) Stresses beyond those listed under *Absolute Maximum Ratings* may cause permanent damage to the device. These are stress ratings only, which do not imply functional operation of the device at these or any other conditions beyond those indicated under *Recommended Operating Conditions*. Exposure to absolute-maximum-rated conditions for extended periods may affect device reliability.
- (2) If Military/Aerospace specified devices are required, please contact the Texas Instruments Sales Office/ Distributors for availability and specifications.
- (3) The maximum allowable power dissipation is a function of the maximum junction temperature, T<sub>J,MAX</sub>, the junction-to-ambient thermal resistance, R<sub>θJA</sub>, and the ambient temperature, T<sub>A</sub>. The maximum allowable power dissipation at any ambient temperature is calculated using:

$$P_{MAX} = \frac{T_{J\_MAX} - T_A}{R_{\theta JA}}$$

Where the value of R<sub>θJA</sub> for the SOT-23 package is 175.7°C/W in a typical PC board mounting and 180°C/W for YZR type DSBGA package or 178.8°C/W for YPB type DSBGA package.

Exceeding the maximum allowable dissipation will cause excessive die temperature, and the regulator will go into thermal shutdown.

- (4) For 12V option, output voltage survival: –0.3 to +16 V. If used in a dual-supply system where the regulator load is returned to a negative supply, the LP2985-N output must be diode-clamped to ground.
- (5) The output PNP structure contains a diode between the IN to OUT pins that is normally reverse-biased. Reversing the polarity from IN to OUT will turn on this diode.

### 7.2 ESD Ratings

|                    |                         |   | VALUE | UNIT |
|--------------------|-------------------------|---|-------|------|
| V <sub>(ESD)</sub> | Electrostatic discharge | Human-body model (HBM), per ANSI/ESDA/JEDEC JS-001 <sup>(1)</sup>   | ±1000 | V    |
|                    |                         | All pins except 3 and 4 (SOT-23)<br>All pins except A3 and B2 (DSBGA)<br>Pins 1, 2, and 5 (SOT-23)<br>Pins A1, C1, and C3 (DSBGA) | ±2000 |      |

- (1) JEDEC document JEP155 states that 500-V HBM allows safe manufacturing with a standard ESD control process.

### 7.3 Recommended Operating Conditions

over operating free-air temperature range (unless otherwise noted)

|                     |                                | MIN                | MAX             | UNIT |
|---------------------|--------------------------------|--------------------|-----------------|------|
| V <sub>IN</sub>     | Supply input voltage           | 3.1 <sup>(1)</sup> | 16              | V    |
| V <sub>ON/OFF</sub> | ON/OFF input voltage           | 0                  | V <sub>IN</sub> | V    |
| I <sub>OUT</sub>    | Output current                 |                    | 150             | mA   |
| T <sub>J</sub>      | Operating junction temperature | –40                | 125             | °C   |

- (1) Recommended minimum V<sub>IN</sub> is the greater of 3.1 V or V<sub>OUT(max)</sub> + rated dropout voltage (max) for operating load current.

## 7.4 Thermal Information

| THERMAL METRIC <sup>(1)</sup> |  | LP2985-N |             |             | UNIT |
|-------------------------------|--|----------|-------------|-------------|------|
|                               |  | SOT-23   | DSBGA (YZR) | DSBGA (YPB) |      |
|                               |  | 5 PINS   |             |             |      |
| R <sub>θJA</sub>              | Junction-to-ambient thermal resistance       | 175.7    | 180         | 178.8       | °C/W |
| R <sub>θJC(top)</sub>         | Junction-to-case (top) thermal resistance    | 78       | 1           | 2.1         |      |
| R <sub>θJB</sub>              | Junction-to-board thermal resistance         | 30.8     | 109.3       | 146.3       |      |
| ψ <sub>JT</sub>               | Junction-to-top characterization parameter   | 2.8      | 7.1         | 1.9         |      |
| ψ <sub>JB</sub>               | Junction-to-board characterization parameter | 30.3     | 109.3       | 146.3       |      |

(1) For more information about traditional and new thermal metrics, see the *IC Package Thermal Metrics* application report, [SPRA953](#).

## 7.5 Electrical Characteristics

Unless otherwise specified: V<sub>IN</sub> = V<sub>O(NOM)</sub> + 1 V, I<sub>L</sub> = 1 mA, C<sub>IN</sub> = 1 μF, C<sub>OUT</sub> = 4.7 μF, V<sub>ON/OFF</sub> = 2 V, T<sub>J</sub> = 25°C.<sup>(1)</sup>

| PARAMETER                         |                                | TEST CONDITIONS   | TYP   | LP2985AI-X.X <sup>(2)</sup> |     | LP2985I-X.X <sup>(2)</sup> |     | UNIT              |
|-----------------------------------|--------------------------------|---|-------|-----------------------------|-----|----------------------------|-----|-------------------|
|                                   |                                |   |       | MIN                         | MAX | MIN                        | MAX |                   |
| ΔV <sub>O</sub>                   | Output voltage tolerance       | I <sub>L</sub> = 1 mA   |       | -1                          | 1   | -1.5                       | 1.5 | %V <sub>NOM</sub> |
|                                   |                                | 1 mA ≤ I <sub>L</sub> ≤ 50 mA   |       | -1.5                        | 1.5 | -2.5                       | 2.5 |                   |
|                                   |                                | 1 mA ≤ I <sub>L</sub> ≤ 50 mA, -40°C ≤ T <sub>J</sub> ≤ 125°C                     |       | -2.5                        | 2.5 | -3.5                       | 3.5 |                   |
|                                   |                                | 1 mA ≤ I <sub>L</sub> ≤ 150 mA  |       | -2.5                        | 2.5 | -3                         | 3   |                   |
|                                   |                                | 1 mA ≤ I <sub>L</sub> ≤ 150 mA, -40°C ≤ T <sub>J</sub> ≤ 125°C                    |       | -3.5                        | 3.5 | -4                         | 4   |                   |
| ΔV <sub>O</sub> /ΔV <sub>IN</sub> | Output voltage                 | V <sub>O(NOM)</sub> +1 V ≤ V <sub>IN</sub> ≤ 16 V                                 | 0.007 | 0.014                       |     | 0.014                      |     | %V                |
|                                   | Line regulation                | V <sub>O(NOM)</sub> +1 V ≤ V <sub>IN</sub> ≤ 16 V, -40°C ≤ T <sub>J</sub> ≤ 125°C |       | 0.032                       |     | 0.032                      |     |                   |
| V <sub>IN</sub> -V <sub>O</sub>   | Dropout voltage <sup>(3)</sup> | I <sub>L</sub> = 0  | 1     | 3                           |     | 3                          |     | mV                |
|                                   |                                | I <sub>L</sub> = 0, -40°C ≤ T <sub>J</sub> ≤ 125°C                                |       | 5                           |     | 5                          |     |                   |
|                                   |                                | I <sub>L</sub> = 1 mA   | 7     | 10                          |     | 10                         |     |                   |
|                                   |                                | I <sub>L</sub> = 1 mA, -40°C ≤ T <sub>J</sub> ≤ 125°C                             |       | 15                          |     | 15                         |     |                   |
|                                   |                                | I <sub>L</sub> = 10 mA  | 40    | 60                          |     | 60                         |     |                   |
|                                   |                                | I <sub>L</sub> = 10 mA, -40°C ≤ T <sub>J</sub> ≤ 125°C                            |       | 90                          |     | 90                         |     |                   |
|                                   |                                | I <sub>L</sub> = 50 mA  | 120   | 150                         |     | 150                        |     |                   |
|                                   |                                | I <sub>L</sub> = 50 mA, -40°C ≤ T <sub>J</sub> ≤ 125°C                            |       | 225                         |     | 225                        |     |                   |
|                                   |                                | I <sub>L</sub> = 150 mA   | 280   | 350                         |     | 350                        |     |                   |
|                                   |                                | I <sub>L</sub> = 150 mA, -40°C ≤ T <sub>J</sub> ≤ 125°C                           |       | 575                         |     | 575                        |     |                   |

(1) Exposing the DSBGA device to direct sunlight will cause misoperation. See [DSBGA Light Sensitivity](#) for additional information.

(2) Limits are 100% production tested at 25°C. Limits over the operating temperature range are ensured through correlation using Statistical Quality Control (SQC) methods. The limits are used to calculate TI's Average Outgoing Quality Level (AOQL).

(3) Dropout voltage is defined as the input to output differential at which the output voltage drops 100 mV below the value measured with a 1 V differential.

**Electrical Characteristics (continued)**

Unless otherwise specified:  $V_{IN} = V_O(NOM) + 1\text{ V}$ ,  $I_L = 1\text{ mA}$ ,  $C_{IN} = 1\text{ }\mu\text{F}$ ,  $C_{OUT} = 4.7\text{ }\mu\text{F}$ ,  $V_{ON/OFF} = 2\text{ V}$ ,  $T_J = 25^\circ\text{C}$ .<sup>(1)</sup>

| PARAMETER                  | TEST CONDITIONS                     | TYP   | LP2985AI-X.X <sup>(2)</sup> |      | LP2985I-X.X <sup>(2)</sup> |      | UNIT          |
|----------------------------|-------------------------------------|---|-----------------------------|------|----------------------------|------|---------------|
|                            |                                     |   | MIN                         | MAX  | MIN                        | MAX  |               |
| $I_{GND}$                  | Ground pin current                  | $I_L = 0$   |                             | 95   |                            | 95   | $\mu\text{A}$ |
|                            |                                     | $I_L = 0, -40^\circ\text{C} \leq T_J \leq 125^\circ\text{C}$                    |                             | 125  |                            | 125  |               |
|                            |                                     | $I_L = 1\text{ mA}$   | 75                          | 110  |                            | 110  |               |
|                            |                                     | $I_L = 1\text{ mA}, -40^\circ\text{C} \leq T_J \leq 125^\circ\text{C}$          |                             | 170  |                            | 170  |               |
|                            |                                     | $I_L = 10\text{ mA}$  | 120                         | 220  |                            | 220  |               |
|                            |                                     | $I_L = 10\text{ mA}, -40^\circ\text{C} \leq T_J \leq 125^\circ\text{C}$         |                             | 400  |                            | 400  |               |
|                            |                                     | $I_L = 50\text{ mA}$  | 350                         | 600  |                            | 600  |               |
|                            |                                     | $I_L = 50\text{ mA}, -40^\circ\text{C} \leq T_J \leq 125^\circ\text{C}$         |                             | 1000 |                            | 1000 |               |
|                            |                                     | $I_L = 150\text{ mA}$   | 850                         | 1500 |                            | 1500 |               |
|                            |                                     | $I_L = 150\text{ mA}, -40^\circ\text{C} \leq T_J \leq 125^\circ\text{C}$        |                             | 2500 |                            | 2500 |               |
|                            |                                     | $V_{ON/OFF} < 0.3\text{ V}$   | 0.01                        | 0.8  |                            | 0.8  |               |
|                            |                                     | $V_{ON/OFF} < 0.15\text{ V}, -40^\circ\text{C} \leq T_J \leq 125^\circ\text{C}$ | 0.05                        | 2    |                            | 2    |               |
| $V_{ON/OFF}$               | ON/OFF input voltage <sup>(4)</sup> | High = O/P ON   |                             |      |                            |      | V             |
|                            |                                     | High = O/P ON, $-40^\circ\text{C} \leq T_J \leq 125^\circ\text{C}$              |                             | 1.6  |                            | 1.6  |               |
|                            |                                     | Low = O/P OFF   | 0.55                        |      |                            |      |               |
|                            |                                     | Low = O/P OFF, $-40^\circ\text{C} \leq T_J \leq 125^\circ\text{C}$              |                             | 0.15 |                            | 0.15 |               |
| $I_{ON/OFF}$               | ON/OFF input current                | $V_{ON/OFF} = 0$  | 0.01                        |      |                            |      | $\mu\text{A}$ |
|                            |                                     | $V_{ON/OFF} = 0, -40^\circ\text{C} \leq T_J \leq 125^\circ\text{C}$             |                             | -2   |                            | -2   |               |
|                            |                                     | $V_{ON/OFF} = 5\text{ V}$   | 5                           |      |                            |      |               |
|                            |                                     | $V_{ON/OFF} = 5\text{ V}, -40^\circ\text{C} \leq T_J \leq 125^\circ\text{C}$    |                             | 15   |                            | 15   |               |
| $e_n$                      | Output noise voltage (RMS)          | BW = 300 Hz to 50 kHz,  |                             |      |                            |      | $\mu\text{V}$ |
|                            |                                     | $C_{OUT} = 10\text{ }\mu\text{F}$   | 30                          |      |                            |      |               |
|                            |                                     | $C_{BYPASS} = 10\text{ nF}$   |                             |      |                            |      |               |
| $\Delta V_O/\Delta V_{IN}$ | Ripple rejection                    | $f = 1\text{ kHz}, C_{BYPASS} = 10\text{ nF}$                                   | 45                          |      |                            |      | dB            |
|                            |                                     | $C_{OUT} = 10\text{ }\mu\text{F}$   |                             |      |                            |      |               |
| $I_O(SC)$                  | Short circuit current               | $R_L = 0$ (Steady State) <sup>(5)</sup>   | 400                         |      |                            |      | mA            |
| $I_O(PK)$                  | Peak output current                 | $V_{OUT} \geq V_O(NOM) - 5\%$   | 350                         |      |                            |      | mA            |

(4) The ON/OFF input must be properly driven to prevent possible misoperation. For details, refer to [ON/OFF Input Operation](#).

(5) The LP2985-N has foldback current limiting which allows a high peak current when  $V_{OUT} > 0.5\text{ V}$ , and then reduces the maximum output current as  $V_{OUT}$  is forced to ground (see [Typical Characteristics](#) curves).

## 7.6 Typical Characteristics

Unless otherwise specified:  $C_{IN} = 1 \mu\text{F}$ ,  $C_{OUT} = 4.7 \mu\text{F}$ ,  $V_{IN} = V_{OUT(NOM)} + 1$ ,  $T_A = 25^\circ\text{C}$ , ON/OFF pin is tied to  $V_{IN}$ .

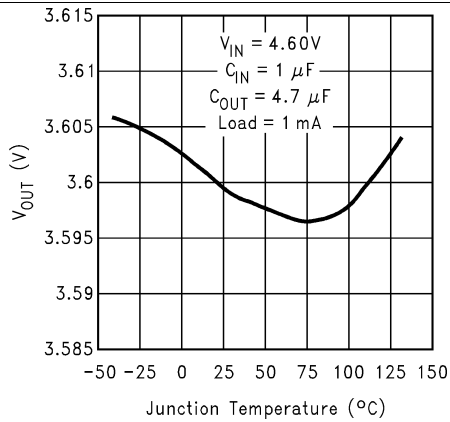

Figure 1.  $V_{OUT}$  vs Temperature

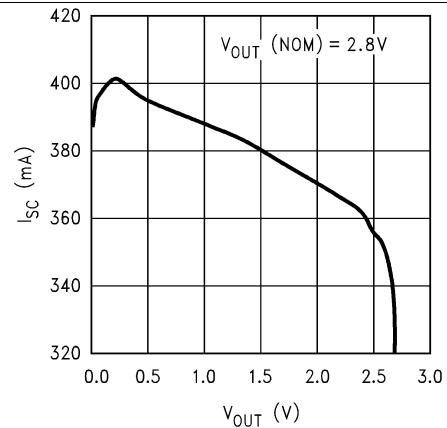

Figure 2. Short Circuit Current vs Output Voltage

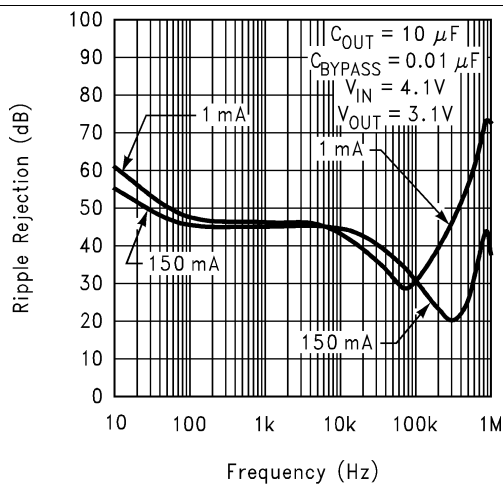

Figure 3. Ripple Rejection

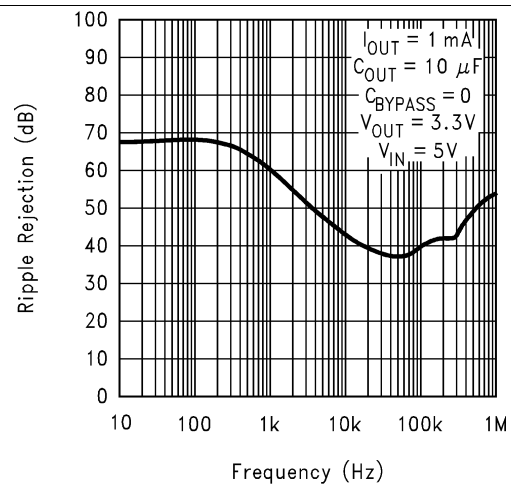

Figure 4. Ripple Rejection

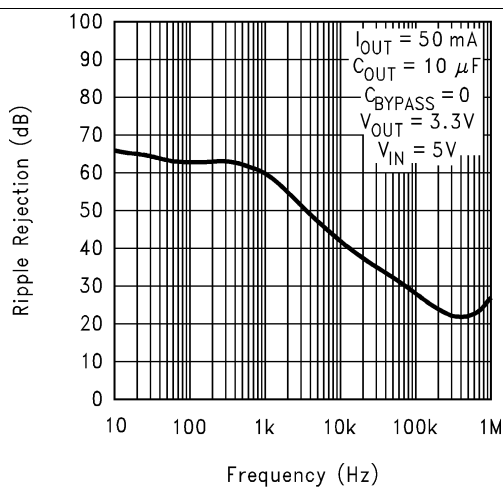

Figure 5. Ripple Rejection

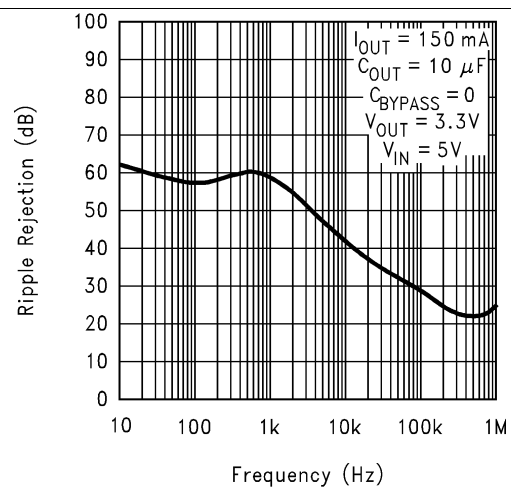

Figure 6. Ripple Rejection



Typical Characteristics (continued)

Unless otherwise specified:  $C_{IN} = 1 \mu F$ ,  $C_{OUT} = 4.7 \mu F$ ,  $V_{IN} = V_{OUT(NOM)} + 1$ ,  $T_A = 25^\circ C$ , ON/OFF pin is tied to  $V_{IN}$ .

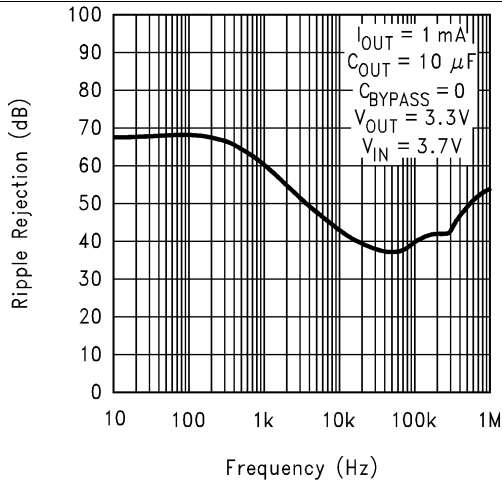

Figure 7. Ripple Rejection

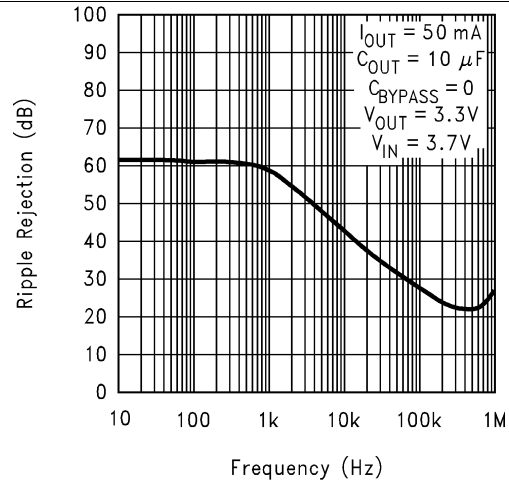

Figure 8. Ripple Rejection

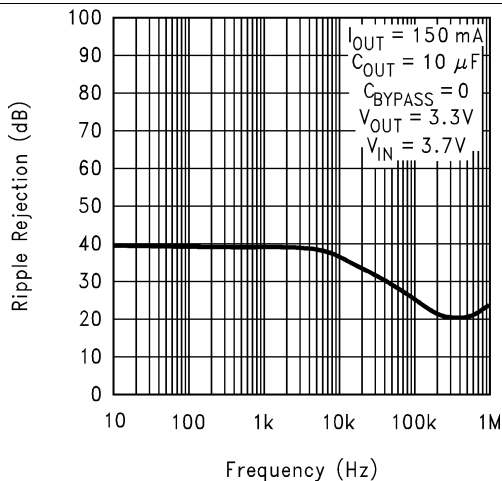

Figure 9. Ripple Rejection

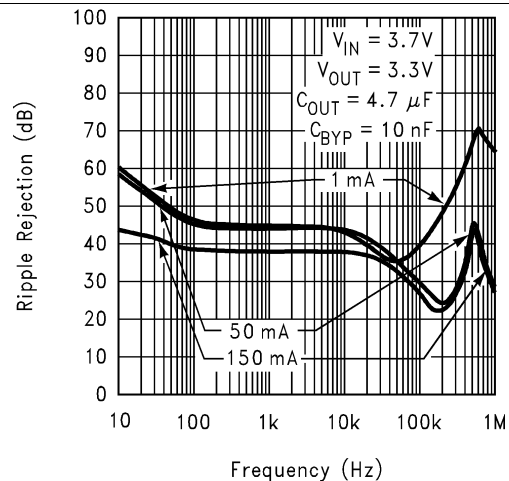

Figure 10. Ripple Rejection

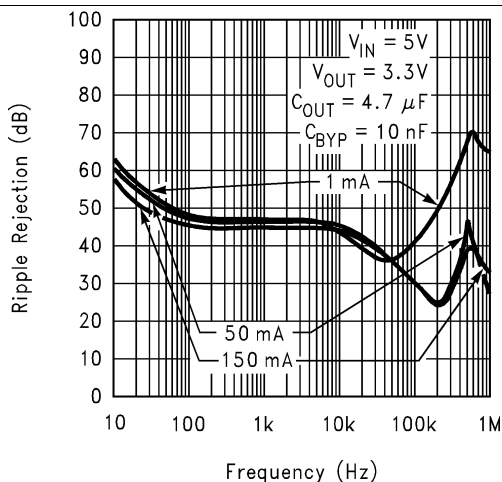

Figure 11. Ripple Rejection

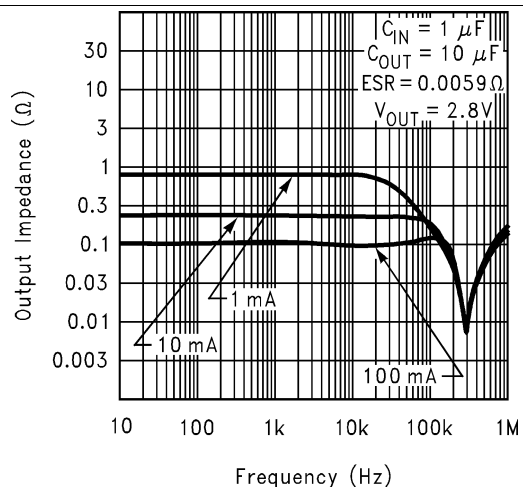

Figure 12. Output Impedance vs Frequency

Typical Characteristics (continued)

Unless otherwise specified:  $C_{IN} = 1 \mu F$ ,  $C_{OUT} = 4.7 \mu F$ ,  $V_{IN} = V_{OUT(NOM)} + 1$ ,  $T_A = 25^\circ C$ , ON/OFF pin is tied to  $V_{IN}$ .

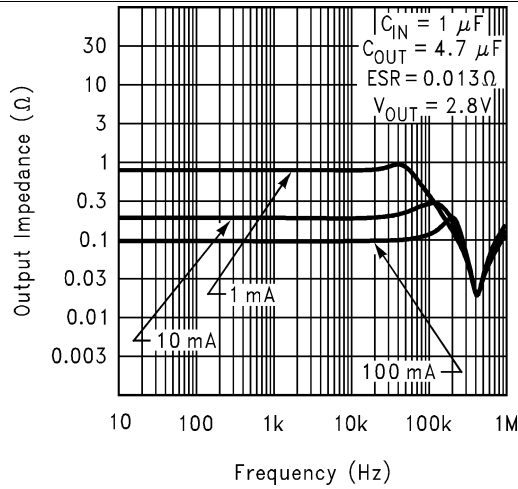

Figure 13. Output Impedance vs Frequency

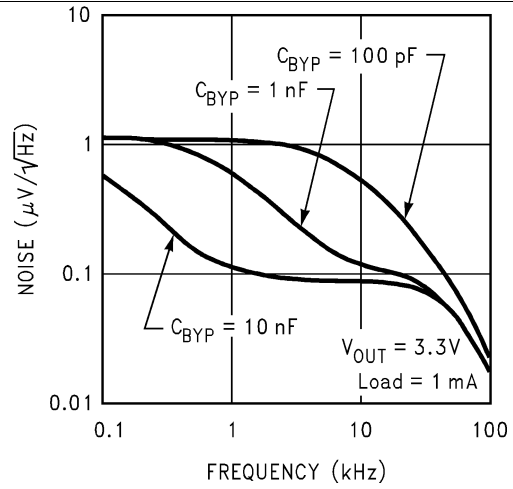

Figure 14. Output Noise Density

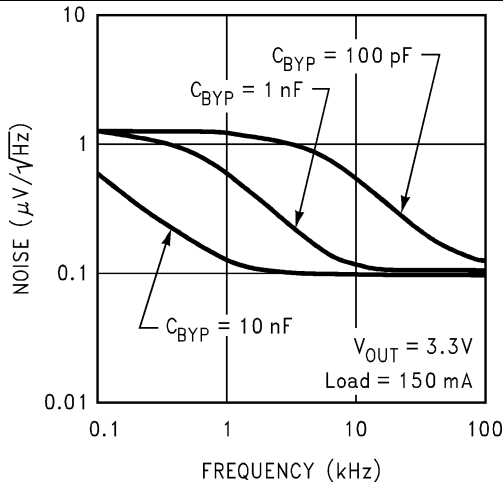

Figure 15. Output Noise Density

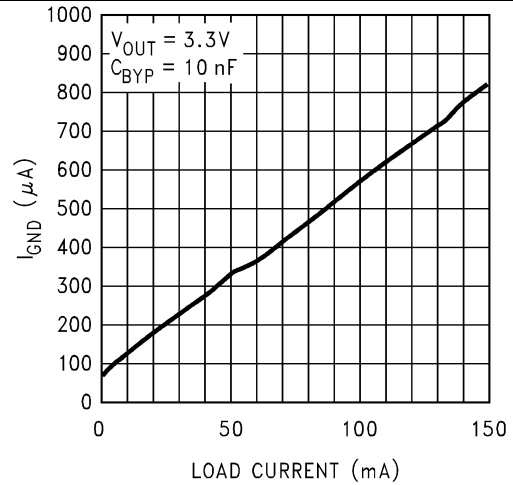

Figure 16. Ground Pin vs Load Current

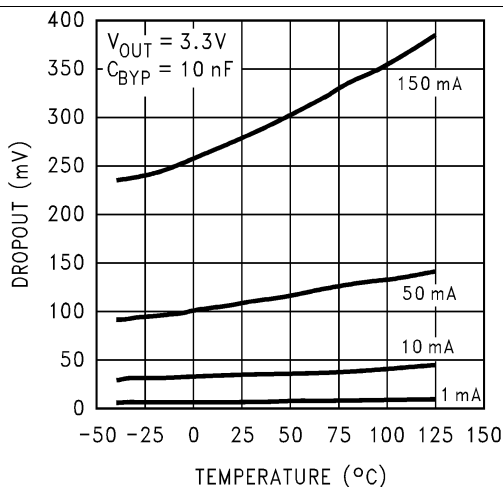

Figure 17. Dropout Voltage vs Temperature

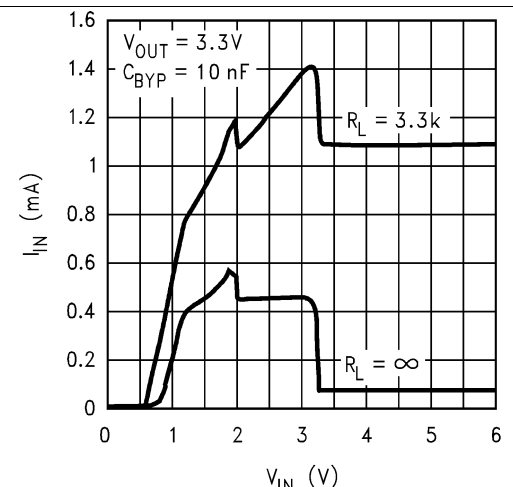
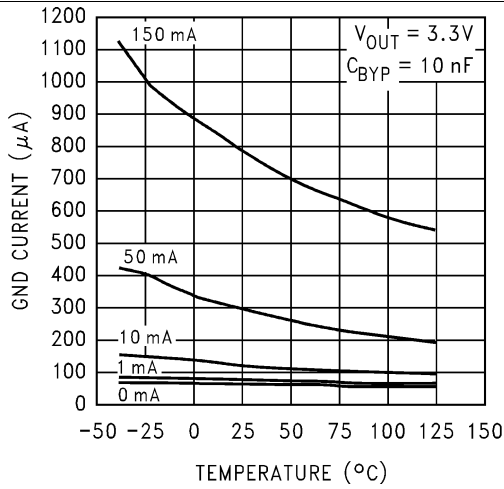

Figure 18. Input Current vs Pin

**Typical Characteristics (continued)**

Unless otherwise specified:  $C_{IN} = 1 \mu F$ ,  $C_{OUT} = 4.7 \mu F$ ,  $V_{IN} = V_{OUT(NOM)} + 1$ ,  $T_A = 25^\circ C$ ,  $ON/\overline{OFF}$  pin is tied to  $V_{IN}$ .



**Figure 19. GND Pin Current vs Temperature**

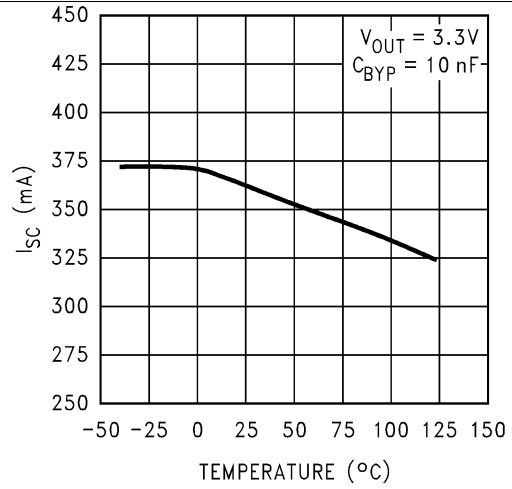

**Figure 20. Instantaneous Short Circuit Current**

## 8 Detailed Description

### 8.1 Overview

The LP2985-N family of fixed-output, ultra-low-dropout and low-noise regulators offers exceptional, cost-effective performance for battery-powered applications. Available in output voltages from 2.5 V to 5 V, the family has an output tolerance of 1% for the A version (1.5% for the non-A version) and is capable of delivering 150-mA continuous load current. Standard regulator features, such as overcurrent and overtemperature protection, are also included.

Using an optimized Vertically Integrated PNP (VIP) process, the LP2985-N contains several features to facilitate battery powered designs:

- Multiple voltage options
- Low dropout voltage, typical dropout of 300 mV at 150 mA load current and 7 mV at 1 mA load.
- Low quiescent current and low ground current, typically 850- $\mu$ A at 150 mA load, and 75- $\mu$ A at 1-mA load.
- A shutdown feature is available, allowing the regulator to consume only 0.01- $\mu$ A typically when the ON/ $\overline{\text{OFF}}$  pin is pulled low.
- Over Temperature Protection and Over Current Protection circuitry is designed to safeguard the device during unexpected conditions
- Enhanced Stability: The LP2985-N is stable with output capacitor ESR as low as 5-m $\Omega$ , which allows the use of ceramic capacitors on the output.
- Low noise: A BYPASS pin allows for low-noise operation, with a typical output noise of 30  $\mu$ V<sub>RMS</sub>, with the use of a 10-nF bypass capacitor.

### 8.2 Functional Block Diagram

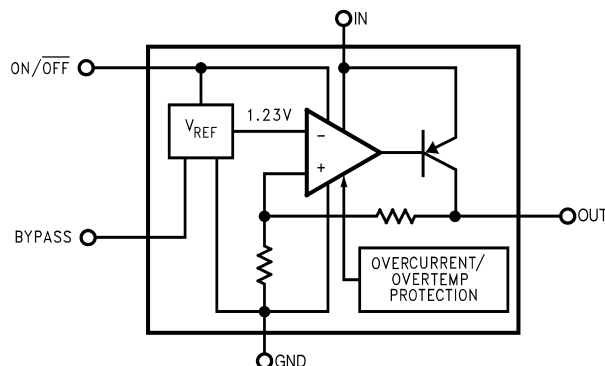

### 8.3 Feature Description

#### 8.3.1 Multiple Voltage Options

In order to meet different application's requirement, the LP2985-N family provide multiple fixed output options from 2.5 V to 6.1 V. Please consult factory for custom voltages.

#### 8.3.2 Output Voltage Accuracy

Output voltage accuracy specifies minimum and maximum output voltage error, relative to the expected nominal output voltage stated as a percent. This accuracy error includes the errors introduced by the internal reference and the load and line regulation across the full range of rated load and line operating conditions over temperature, unless otherwise specified by the [Electrical Characteristics](#). Output voltage accuracy also accounts for all variations between manufacturing lots.

## Feature Description (continued)

### 8.3.3 Ultra-Low Dropout Voltage

Generally speaking, the dropout voltage often refers to the voltage difference between the input and output voltage ( $V_{DO} = V_{IN} - V_{OUT}$ ), where the main current pass-FET is fully on in the ohmic region of operation and is characterized by the classic  $R_{DS(ON)}$  of the FET.  $V_{DO}$  indirectly specifies a minimum input voltage above the nominal programmed output voltage at which the output voltage is expected to remain within its accuracy boundary. If the input falls below this  $V_{DO}$  limit ( $V_{IN} < V_{OUT} + V_{DO}$ ), then the output voltage decreases in order to follow the input voltage.

### 8.3.4 Low Ground Current

LP2985-N uses a vertical PNP process which allows for quiescent currents that are considerably lower than those associated with traditional lateral PNP regulators, typically 850  $\mu$ A at 150 mA load, and 75  $\mu$ A at 1-mA load.

### 8.3.5 Sleep Mode

When pull ON/OFF pin to low level, LP2985-N will enter sleep mode, and less than 2- $\mu$ A quiescent current is consumed. This function is designed for the application which needs a sleep mode to effectively enhance battery life cycle.

### 8.3.6 Internal Protection Circuitry

#### 8.3.6.1 Short Circuit Protection (Current Limit)

The internal current limit circuit is used to protect the LDO against high-load current faults or shorting events. The LDO is not designed to operate in a steady-state current limit. During a current-limit event, the LDO sources constant current. Therefore, the output voltage falls when load impedance decreases. Note also that if a current limit occurs and the resulting output voltage is low, excessive power may be dissipated across the LDO, resulting in a thermal shutdown of the output.

A fold back feature limits the short-circuit current to protect the regulator from damage under all load conditions. If  $V_{OUT}$  is forced below 0 V before EN goes high and the load current required exceeds the fold back current limit, the device may not start up correctly.

#### 8.3.6.2 Thermal Protection

The LP2985-N contains a thermal shutdown protection circuit to turn off the output current when excessive heat is dissipated in the LDO. The thermal time-constant of the semiconductor die is fairly short, and thus the output cycles on and off at a high rate when thermal shutdown is reached until the power dissipation is reduced.

The internal protection circuitry of the LP2985-N is designed to protect against thermal overload conditions. The circuitry is not intended to replace proper heat sinking. Continuously running the device into thermal shutdown degrades its reliability.

### 8.3.7 Enhanced Stability

The LP2985-N is designed specifically to work with ceramic output capacitors, utilizing circuitry which allows the regulator to be stable across the entire range of output current with an output capacitor whose ESR is as low as 5 m $\Omega$ . For output capacitor requirement, please refer to [Output Capacitor](#).

### 8.3.8 Low Noise

The LP2985-N includes a low-noise reference ensuring minimal noise during operation because the internal reference is normally the dominant term in noise analysis. Further noise reduction can be achieved by adding an external bypass capacitor between the BYPASS pin and the GND pin.

## 8.4 Device Functional Modes

### 8.4.1 Operation with $V_{OUT(TARGET)} + 0.6 V \geq V_{IN} > 16 V$

The device operate if the input voltage is equal to, or exceeds  $V_{OUT(TARGET)} + 0.6 V$ . At input voltages below the minimum  $V_{IN}$  requirement, the devices do not operate correctly and output voltage may not reach target value.

## Device Functional Modes (continued)

### 8.4.2 Operation With ON/ $\overline{\text{OFF}}$ Control

If the voltage on the ON/ $\overline{\text{OFF}}$  pin is less than 0.15 V, the device is disabled, and in this state shutdown current does not exceed 2  $\mu\text{A}$ . Raising ON/ $\overline{\text{OFF}}$  above 1.6 V initiates the start-up sequence of the device.

## 9 Application and Implementation

### NOTE

Information in the following applications sections is not part of the TI component specification, and TI does not warrant its accuracy or completeness. TI's customers are responsible for determining suitability of components for their purposes. Customers should validate and test their design implementation to confirm system functionality.

### 9.1 Application Information

The LP2985-N is a linear voltage regulator operating from 2.5 V to 16 V on the input and regulates voltages between 2.5 V to 6.1 V with 1% accuracy and 150-mA maximum output current. Efficiency is defined by the ratio of output voltage to input voltage because the LP2985-N is a linear voltage regulator. To achieve high efficiency, the dropout voltage ( $V_{IN} - V_{OUT}$ ) must be as small as possible, thus requiring a very-low-dropout LDO. Successfully implementing an LDO in an application depends on the application requirements. If the requirements are simply input voltage and output voltage, compliance specifications (such as internal power dissipation or stability) must be verified to ensure a solid design. If timing, start-up, noise, power supply rejection ratio (PSRR), or any other transient specification is required, then the design becomes more challenging.

### 9.2 Typical Application

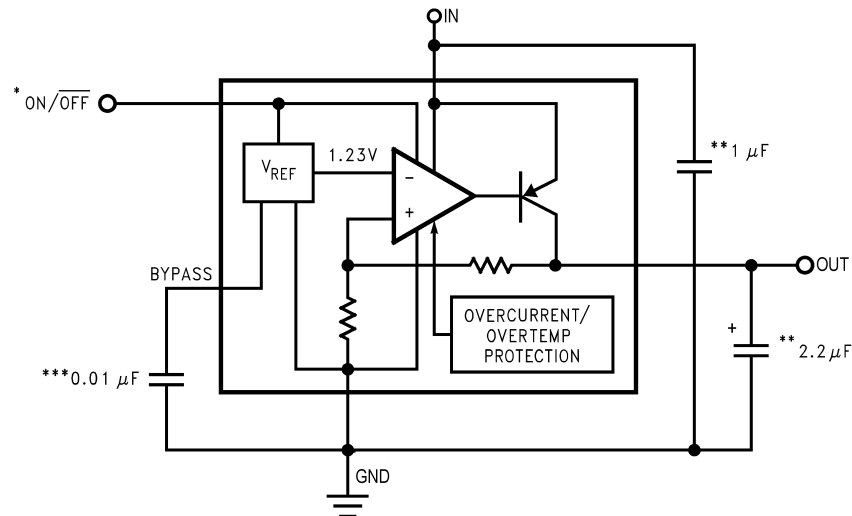

\*ON/ $\overline{\text{OFF}}$  input must be actively terminated. Tie to  $V_{IN}$  if this function is not to be used.

\*\*Minimum capacitance is shown to ensure stability (may be increased without limit). Ceramic capacitor required for output (see [Output Capacitor](#)).

\*\*\*Reduces output noise (may be omitted if application is not noise critical). Use ceramic or film type with very low leakage current (see [Noise Bypass Capacitor](#)).

Figure 21. Typical Application Schematic

#### 9.2.1 Design Requirements

| DESIGN PARAMETERS           | VALUE  |
|-----------------------------|--|
| Input voltage               | 4.3 V, $\pm 10\%$ provided by the DC-DC converter switching at 1 MHz |
| Output voltage              | 3.3 V, $\pm 5\%$   |
| Output current              | 150 mA (maximum), 1 mA (minimum)                                     |
| RMS noise, 300 Hz to 50 kHz | $< 50 \mu V_{RMS}$   |
| PSRR at 1 kHz               | $> 40$ dB  |

## 9.2.2 Detailed Design Procedure

At 150-mA loading, the dropout of the LP2985-N has 575-mV maximum dropout over temperature, thus an 1000-mV headroom is sufficient for operation over both input and output voltage accuracy. The efficiency of the LP2985-N in this configuration is  $V_{OUT} / V_{IN} = 76.7\%$ . To achieve the smallest form factor, the SOT-23 package is selected.

Input and output capacitors are selected in accordance with the [Capacitor Characteristics](#) section. Ceramic capacitances of 1  $\mu\text{F}$  for the input and one 2.2- $\mu\text{F}$  capacitor for the output are selected. With an efficiency of 76.7% and a 150 mA maximum load, the internal power dissipation is 150-mW, which corresponds to a 26°C junction temperature rise for the SOT-23 package. With an 85°C maximum ambient temperature, the junction temperature is at 111°C. To minimize noise, a bypass capacitance ( $C_{BYPASS}$ ) of 0.01  $\mu\text{F}$  is selected.

### 9.2.2.1 External Capacitors

Like any low-dropout regulator, the LP2985-N requires external capacitors for regulator stability. These capacitors must be correctly selected for good performance.

#### 9.2.2.1.1 Input Capacitor

An input capacitor whose capacitance is  $\geq 1 \mu\text{F}$  is required between the LP2985-N input and ground (the amount of capacitance may be increased without limit).

This capacitor must be located a distance of not more than 1 cm from the input pin and returned to a clean analog ground. Any good quality ceramic, tantalum, or film capacitor may be used at the input.

---

#### NOTE

Tantalum capacitors can suffer catastrophic failure due to surge current when connected to a low-impedance source of power (like a battery or very large capacitor). If a Tantalum capacitor is used at the input, it must be ensured by the manufacturer to have a surge current rating sufficient for the application.

---

There are no requirements for ESR on the input capacitor, but tolerance and temperature coefficient must be considered when selecting the capacitor to ensure the capacitance will be  $\geq 1 \mu\text{F}$  over the entire operating temperature range.

#### 9.2.2.1.2 Output Capacitor

The LP2985-N is designed specifically to work with ceramic output capacitors, utilizing circuitry which allows the regulator to be stable across the entire range of output current with an output capacitor whose ESR is as low as 5 m $\Omega$ . It may also be possible to use Tantalum or film capacitors at the output, but these are not as attractive for reasons of size and cost (see [Capacitor Characteristics](#)).

The output capacitor must meet the requirement for minimum amount of capacitance and also have an ESR value which is within the stable range. Curves are provided which show the stable ESR range as a function of load current (see [Figure 22](#)).



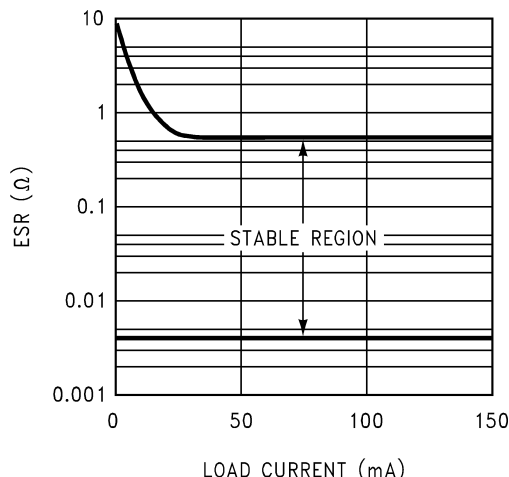

**Figure 22. ESR Graph**

**NOTE**

The output capacitor must maintain its ESR within the stable region over the full operating temperature range of the application to assure stability.

The LP2985-N requires a minimum of 2.2  $\mu\text{F}$  on the output (output capacitor size can be increased without limit).

It is important to remember that capacitor tolerance and variation with temperature must be taken into consideration when selecting an output capacitor so that the minimum required amount of output capacitance is provided over the full operating temperature range. It should be noted that ceramic capacitors can exhibit large changes in capacitance with temperature (see [Capacitor Characteristics](#)). The output capacitor must be located not more than 1 cm from the output pin and returned to a clean analog ground.

**9.2.2.1.3 Noise Bypass Capacitor**

Connecting a 10 nF capacitor to the BYPASS pin significantly reduces noise on the regulator output. It should be noted that the capacitor is connected directly to a high-impedance circuit in the bandgap reference.

Because this circuit has only a few microamperes flowing in it, any significant loading on this node will cause a change in the regulated output voltage. For this reason, DC leakage current through the noise bypass capacitor must never exceed 100 nA, and should be kept as low as possible for best output voltage accuracy.

The types of capacitors best suited for the noise bypass capacitor are ceramic and film. High-quality ceramic capacitors with either NPO or COG dielectric typically have very low leakage. 10 nF polypropylene and polycarbonate film capacitors are available in small surface-mount packages and typically have extremely low leakage current.

**9.2.2.2 Capacitor Characteristics**

The LP2985-N was designed to work with ceramic capacitors on the output to take advantage of the benefits they offer: for capacitance values in the 2.2  $\mu\text{F}$  to 4.7  $\mu\text{F}$  range, ceramics are the least expensive and also have the lowest ESR values (which makes them best for eliminating high-frequency noise). The ESR of a typical 2.2  $\mu\text{F}$  ceramic capacitor is in the range of 10 m $\Omega$  to 20 m $\Omega$ , which easily meets the ESR limits required for stability by the LP2985-N.

One disadvantage of ceramic capacitors is that their capacitance can vary with temperature. Most large value ceramic capacitors ( $\geq 2.2 \mu\text{F}$ ) are manufactured with the Z5U or Y5V temperature characteristic, which results in the capacitance dropping by more than 50% as the temperature goes from 25°C to 85°C.

This could cause problems if a 2.2  $\mu\text{F}$  capacitor were used on the output since it will drop down to approximately 1  $\mu\text{F}$  at high ambient temperatures (which could cause the LM2985 to oscillate). If Z5U or Y5V capacitors are used on the output, a minimum capacitance value of 4.7  $\mu\text{F}$  must be observed.

A better choice for temperature coefficient in ceramic capacitors is X7R, which holds the capacitance within  $\pm 15\%$ . Unfortunately, the larger values of capacitance are not offered by all manufacturers in the X7R dielectric.

Tantalum capacitors are less desirable than ceramics for use as output capacitors because they are more expensive when comparing equivalent capacitance and voltage ratings in the  $1\ \mu\text{F}$  to  $4.7\ \mu\text{F}$  range.

Another important consideration is that Tantalum capacitors have higher ESR values than equivalent size ceramics. This means that while it may be possible to find a Tantalum capacitor with an ESR value within the stable range, it would have to be larger in capacitance (which means bigger and more costly) than a ceramic capacitor with the same ESR value.

It should also be noted that the ESR of a typical Tantalum will increase about 2:1 as the temperature goes from  $25^\circ\text{C}$  down to  $-40^\circ\text{C}$ , so some guard band must be allowed.

### 9.2.2.3 ON/OFF Input Operation

The LP2985-N is shut off by driving the ON/OFF input low, and turned on by pulling it high. If this feature is not to be used, the ON/OFF input should be tied to  $V_{\text{IN}}$  to keep the regulator output on at all times.

To assure proper operation, the signal source used to drive the ON/OFF input must be able to swing above and below the specified turn-on/turn-off voltage thresholds listed in the [Electrical Characteristics](#) section under  $V_{\text{ON/OFF}}$ . To prevent mis-operation, the turn-on (and turn-off) voltage signals applied to the ON/OFF input must have a slew rate which is  $\geq 40\ \text{mV}/\mu\text{s}$ .

#### CAUTION

The regulator output voltage cannot be ensured if a slow-moving AC (or DC) signal is applied that is in the range between the specified turn-on and turn-off voltages listed under the electrical specification  $V_{\text{ON/OFF}}$  (see [Electrical Characteristics](#)).

### 9.2.2.4 Reverse Input-Output Voltage

The PNP power transistor used as the pass element in the LP2985-N has an inherent diode connected between the regulator output and input. During normal operation (where the input voltage is higher than the output) this diode is reverse-biased).

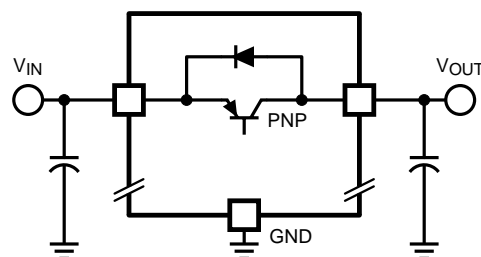

Figure 23. Reverse Current Path

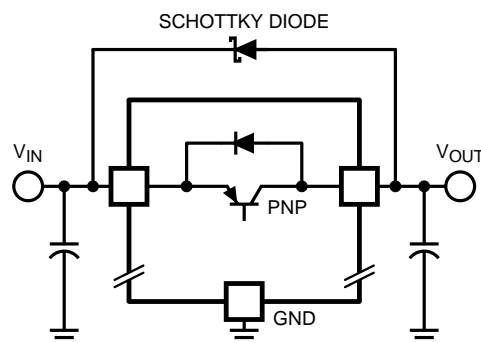
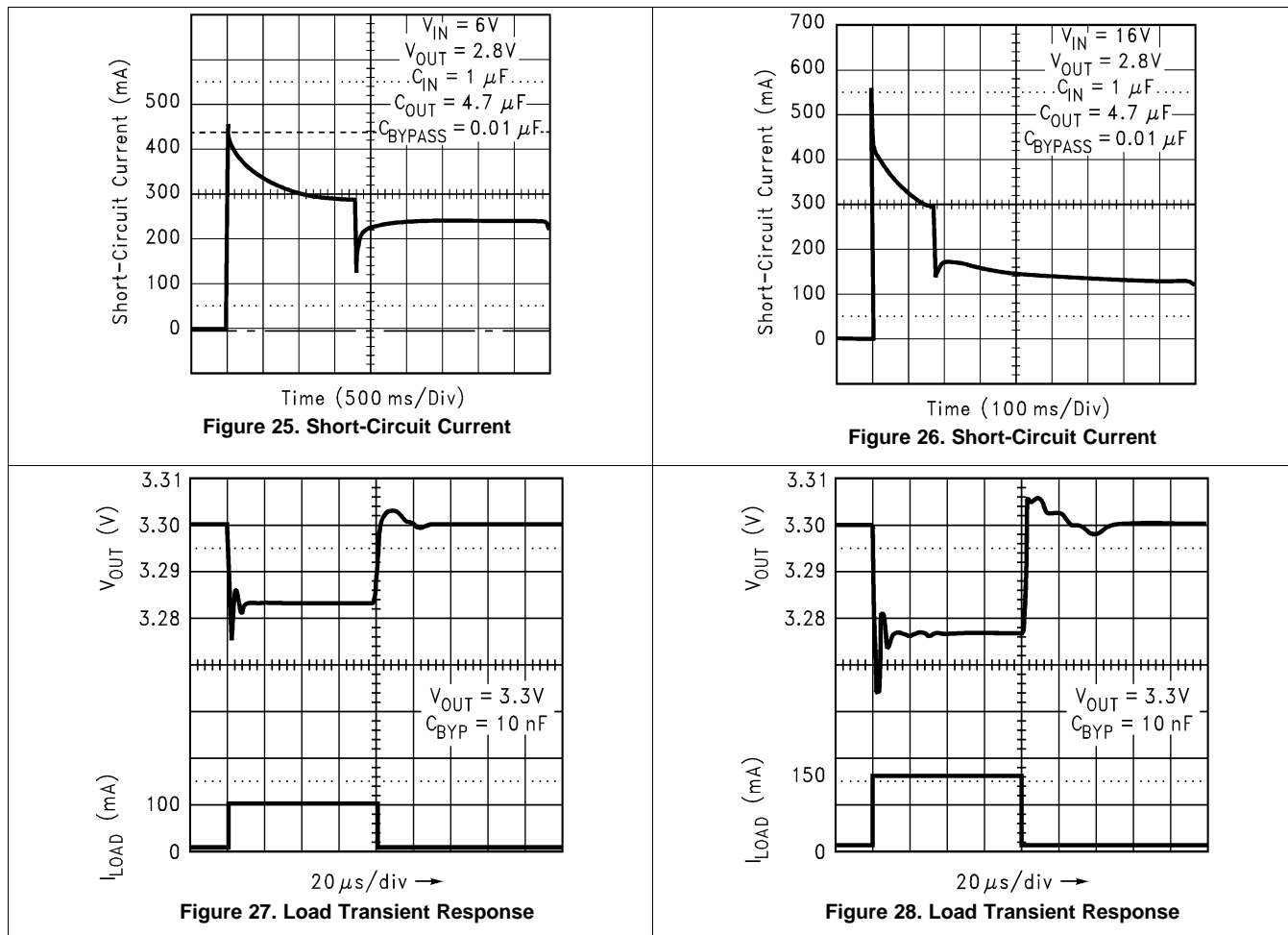

Figure 24. Reverse Current Protection

However, if the output is pulled above the input, this diode will turn ON and current will flow into the regulator output. In such cases, a parasitic SCR can latch which will allow a high current to flow into  $V_{IN}$  (and out the ground pin), which can damage the part.

In any application where the output may be pulled above the input, an external Schottky diode must be connected from  $V_{IN}$  to  $V_{OUT}$  (cathode on  $V_{IN}$ , anode on  $V_{OUT}$ ), to limit the reverse voltage across the LP2985-N to 0.3 V (see [Absolute Maximum Ratings](#)).

### 9.2.3 Application Curves



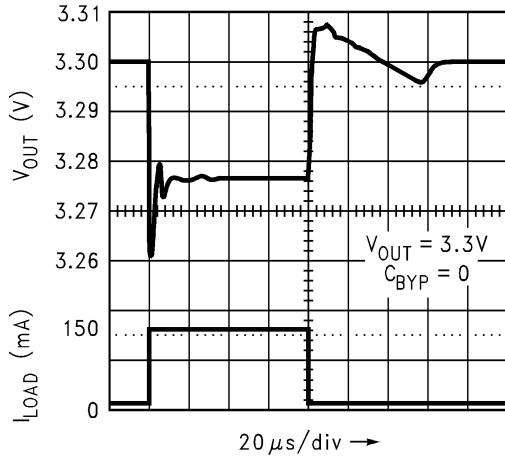

Figure 29. Load Transient Response

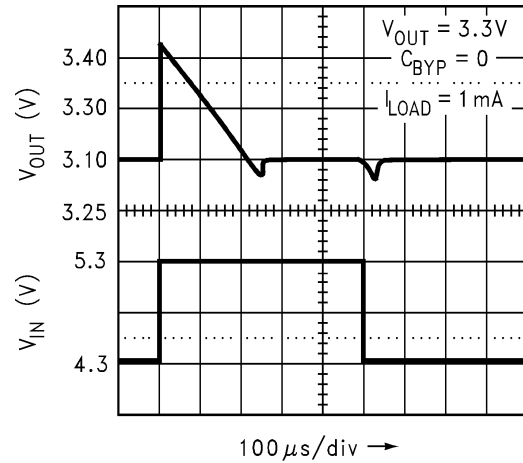

Figure 30. Line Transient Response

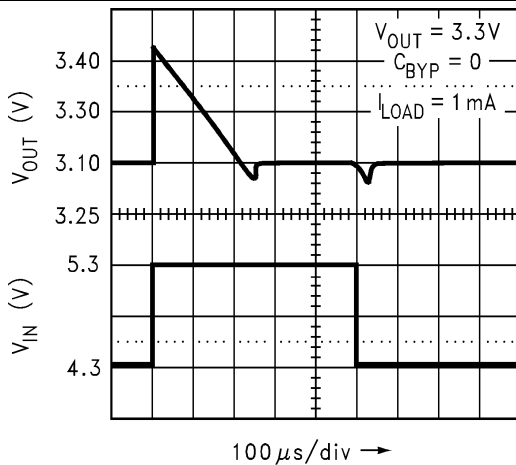

Figure 31. Line Transient Response

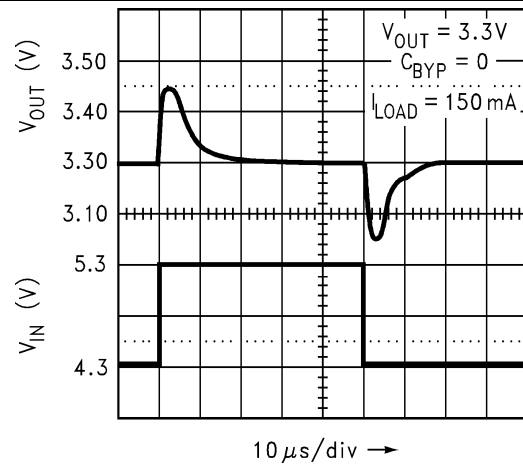

Figure 32. Line Transient Response

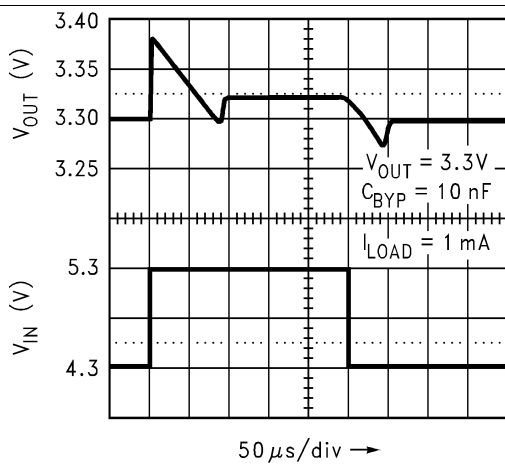

Figure 33. Line Transient Response

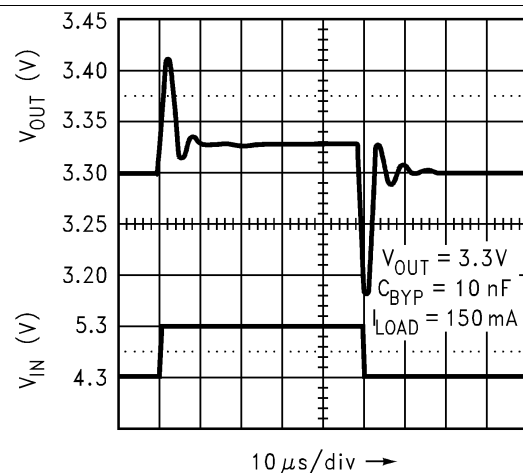

Figure 34. Line Transient Response

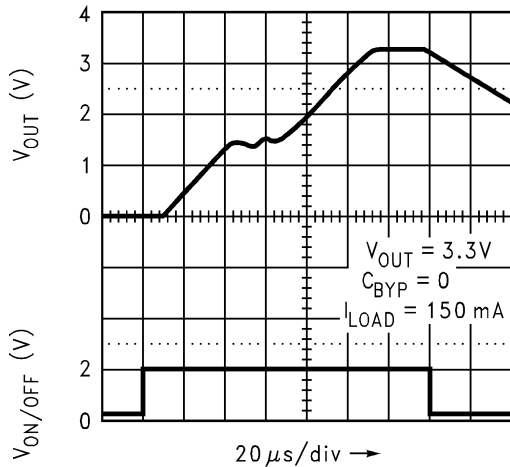

Figure 35. Turn-On Time

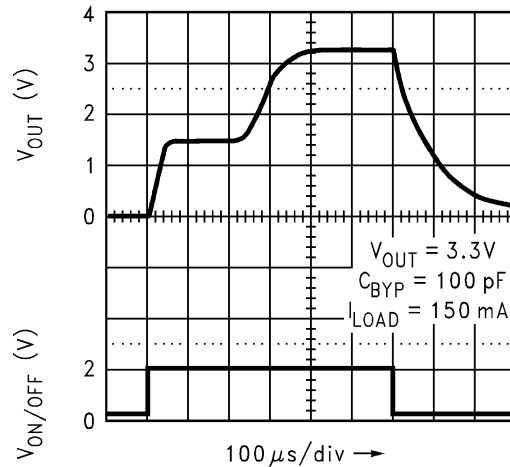

Figure 36. Turn-On Time

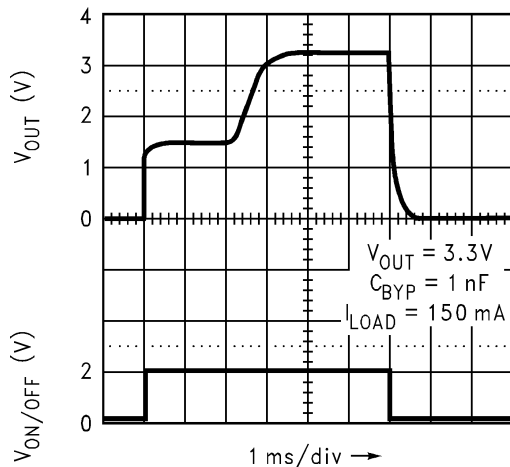

Figure 37. Turn-On Time

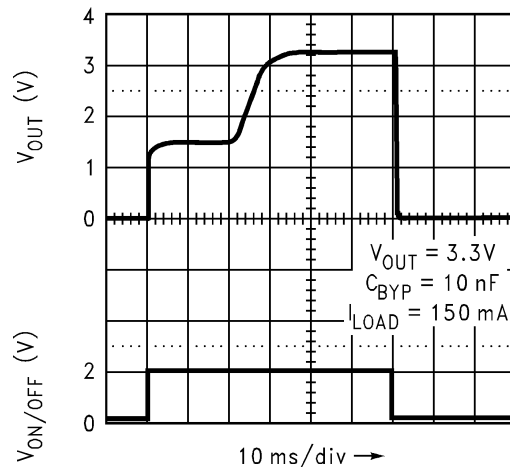

Figure 38. Turn-On Time

## 10 Power Supply Recommendations

The LP2985-N is designed to operate from an input voltage supply range between  $V_{IN}$  of 2.5 V and 16 V. (Recommended minimum  $V_{IN}$  is the greater of 3.1 V or  $V_{OUT(max)}$  + rated dropout voltage (max) for operating load current.) The input voltage range provides adequate headroom in order for the device to have a regulated output. This input supply must be well regulated. If the input supply is noisy, additional input capacitors with low ESR can help to improve the output noise performance.

## 11 Layout

### 11.1 Layout Guidelines

For best overall performance, place all circuit components on the same side of the circuit board and as near as practical to the respective LDO pin connections. Place ground return connections to the input and output capacitor, and to the LDO ground pin as close to each other as possible, connected by a wide, component-side, copper surface. The use of vias and long traces to create LDO circuit connections is strongly discouraged and negatively affects system performance. This grounding and layout scheme minimizes inductive parasitics, and thereby reduces load-current transients, minimizes noise, and increases circuit stability.

A ground reference plane is also recommended and is either embedded in the PCB itself or located on the bottom side of the PCB opposite the components. This reference plane serves to assure accuracy of the output voltage, shield noise, and behaves similar to a thermal plane to spread (or sink) heat from the LDO device. In most applications, this ground plane is necessary to meet thermal requirements.

### 11.2 Layout Example

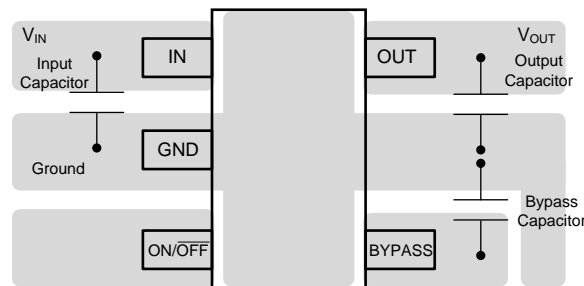

Figure 39. LP2985 SOT-23 Package Typical Layout

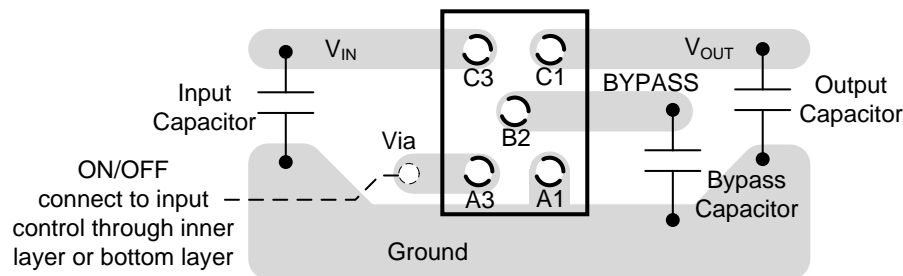

Figure 40. LP2985 DSBGA Package Typical Layout

### 11.3 DSBGA Mounting

The DSBGA package requires specific mounting techniques which are detailed in *AN-1112 DSBGA Wafer Level Chip Scale Package (SNVA009)*. Referring to the section *Surface Mount Technology (SMT) Assembly Considerations*, it should be noted that the pad style which must be used with the 5-pin package is the NSMD (non-solder mask defined) type.

For best results during assembly, alignment ordinals on the PC board may be used to facilitate placement of the DSBGA device.

## 11.4 DSBGA Light Sensitivity

Exposing the DSBGA device to direct sunlight will cause misoperation of the device. Light sources such as Halogen lamps can also affect electrical performance if brought near to the device.

The wavelengths which have the most detrimental effect are reds and infra-reds, which means that the fluorescent lighting used inside most buildings has very little effect on performance. A DSBGA test board was brought to within 1 cm of a fluorescent desk lamp and the effect on the regulated output voltage was negligible, showing a deviation of less than 0.1% from nominal.

## 12 Device and Documentation Support

### 12.1 Documentation Support

#### 12.1.1 Related Documentation

*AN-1112 DSBGA Wafer Level Chip Scale Package* ([SNVA009](#))

### 12.2 Community Resources

The following links connect to TI community resources. Linked contents are provided "AS IS" by the respective contributors. They do not constitute TI specifications and do not necessarily reflect TI's views; see TI's [Terms of Use](#).

**TI E2E™ Online Community** *TI's Engineer-to-Engineer (E2E) Community*. Created to foster collaboration among engineers. At [e2e.ti.com](#), you can ask questions, share knowledge, explore ideas and help solve problems with fellow engineers.

**Design Support** *TI's Design Support* Quickly find helpful E2E forums along with design support tools and contact information for technical support.

### 12.3 Trademarks

E2E is a trademark of Texas Instruments.  
All other trademarks are the property of their respective owners.

### 12.4 Electrostatic Discharge Caution



These devices have limited built-in ESD protection. The leads should be shorted together or the device placed in conductive foam during storage or handling to prevent electrostatic damage to the MOS gates.

### 12.5 Glossary

[SLYZ022](#) — *TI Glossary*.

This glossary lists and explains terms, acronyms, and definitions.

## 13 Mechanical, Packaging, and Orderable Information

The following pages include mechanical, packaging, and orderable information. This information is the most current data available for the designated devices. This data is subject to change without notice and revision of this document. For browser-based versions of this data sheet, refer to the left-hand navigation.



**PACKAGING INFORMATION**

| Orderable Device    | Status<br>(1) | Package Type | Package Drawing | Pins | Package Qty | Eco Plan<br>(2)         | Lead/Ball Finish<br>(6) | MSL Peak Temp<br>(3) | Op Temp (°C) | Device Marking<br>(4/5) | Samples                 |
|---------------------|---------------|--------------|-----------------|------|-------------|-------------------------|-------------------------|----------------------|--------------|-------------------------|-------------------------|
| LP2985AIM5-2.5/NOPB | ACTIVE        | SOT-23       | DBV             | 5    | 1000        | Green (RoHS & no Sb/Br) | CU SN                   | Level-1-260C-UNLIM   | -40 to 125   | LAUA                    | <a href="#">Samples</a> |
| LP2985AIM5-2.7/NOPB | ACTIVE        | SOT-23       | DBV             | 5    | 1000        | Green (RoHS & no Sb/Br) | CU SN                   | Level-1-260C-UNLIM   | -40 to 125   | LALA                    | <a href="#">Samples</a> |
| LP2985AIM5-2.8      | NRND          | SOT-23       | DBV             | 5    | 1000        | TBD                     | Call TI                 | Call TI              | -40 to 125   | L0KA                    |                         |
| LP2985AIM5-2.8/NOPB | ACTIVE        | SOT-23       | DBV             | 5    | 1000        | Green (RoHS & no Sb/Br) | CU SN                   | Level-1-260C-UNLIM   | -40 to 125   | L0KA                    | <a href="#">Samples</a> |
| LP2985AIM5-2.9/NOPB | ACTIVE        | SOT-23       | DBV             | 5    | 1000        | Green (RoHS & no Sb/Br) | CU SN                   | Level-1-260C-UNLIM   | -40 to 125   | LAXA                    | <a href="#">Samples</a> |
| LP2985AIM5-3.0      | NRND          | SOT-23       | DBV             | 5    | 1000        | TBD                     | Call TI                 | Call TI              | -40 to 125   | L0OA                    |                         |
| LP2985AIM5-3.0/NOPB | ACTIVE        | SOT-23       | DBV             | 5    | 1000        | Green (RoHS & no Sb/Br) | CU SN                   | Level-1-260C-UNLIM   | -40 to 125   | L0OA                    | <a href="#">Samples</a> |
| LP2985AIM5-3.1/NOPB | ACTIVE        | SOT-23       | DBV             | 5    | 1000        | Green (RoHS & no Sb/Br) | CU SN                   | Level-1-260C-UNLIM   | -40 to 125   | L0PA                    | <a href="#">Samples</a> |
| LP2985AIM5-3.3      | NRND          | SOT-23       | DBV             | 5    | 1000        | TBD                     | Call TI                 | Call TI              | -40 to 125   | L0RA                    |                         |
| LP2985AIM5-3.3/NOPB | ACTIVE        | SOT-23       | DBV             | 5    | 1000        | Green (RoHS & no Sb/Br) | CU SN                   | Level-1-260C-UNLIM   | -40 to 125   | L0RA                    | <a href="#">Samples</a> |
| LP2985AIM5-3.6      | NRND          | SOT-23       | DBV             | 5    | 1000        | TBD                     | Call TI                 | Call TI              | -40 to 125   | L0SA                    |                         |
| LP2985AIM5-3.6/NOPB | ACTIVE        | SOT-23       | DBV             | 5    | 1000        | Green (RoHS & no Sb/Br) | CU SN                   | Level-1-260C-UNLIM   | -40 to 125   | L0SA                    | <a href="#">Samples</a> |
| LP2985AIM5-3.8/NOPB | ACTIVE        | SOT-23       | DBV             | 5    | 1000        | Green (RoHS & no Sb/Br) | CU SN                   | Level-1-260C-UNLIM   | -40 to 125   | L0YA                    | <a href="#">Samples</a> |
| LP2985AIM5-4.0/NOPB | ACTIVE        | SOT-23       | DBV             | 5    | 1000        | Green (RoHS & no Sb/Br) | CU SN                   | Level-1-260C-UNLIM   | -40 to 125   | L0TA                    | <a href="#">Samples</a> |
| LP2985AIM5-4.5/NOPB | ACTIVE        | SOT-23       | DBV             | 5    | 1000        | Green (RoHS & no Sb/Br) | CU SN                   | Level-1-260C-UNLIM   | -40 to 125   | LA7A                    | <a href="#">Samples</a> |
| LP2985AIM5-5.0      | NRND          | SOT-23       | DBV             | 5    | 1000        | TBD                     | Call TI                 | Call TI              | -40 to 125   | L0UA                    |                         |
| LP2985AIM5-5.0/NOPB | ACTIVE        | SOT-23       | DBV             | 5    | 1000        | Green (RoHS & no Sb/Br) | CU SN                   | Level-1-260C-UNLIM   | -40 to 125   | L0UA                    | <a href="#">Samples</a> |
| LP2985AIM5-5.7/NOPB | ACTIVE        | SOT-23       | DBV             | 5    | 1000        | Green (RoHS & no Sb/Br) | CU SN                   | Level-1-260C-UNLIM   | -40 to 125   | LKTA                    | <a href="#">Samples</a> |
| LP2985AIM5-6.1/NOPB | ACTIVE        | SOT-23       | DBV             | 5    | 1000        | Green (RoHS & no Sb/Br) | CU SN                   | Level-1-260C-UNLIM   | -40 to 125   | LF6A                    | <a href="#">Samples</a> |

| Orderable Device     | Status<br>(1) | Package Type | Package Drawing | Pins | Package Qty | Eco Plan<br>(2)         | Lead/Ball Finish<br>(6) | MSL Peak Temp<br>(3) | Op Temp (°C) | Device Marking<br>(4/5) | Samples                 |
|----------------------|---------------|--------------|-----------------|------|-------------|-------------------------|-------------------------|----------------------|--------------|-------------------------|-------------------------|
| LP2985AIM5X-2.5      | NRND          | SOT-23       | DBV             | 5    | 3000        | TBD                     | Call TI                 | Call TI              | -40 to 125   | LAUA                    |                         |
| LP2985AIM5X-2.5/NOPB | ACTIVE        | SOT-23       | DBV             | 5    | 3000        | Green (RoHS & no Sb/Br) | CU SN                   | Level-1-260C-UNLIM   | -40 to 125   | LAUA                    | <a href="#">Samples</a> |
| LP2985AIM5X-2.6/NOPB | ACTIVE        | SOT-23       | DBV             | 5    | 3000        | Green (RoHS & no Sb/Br) | CU SN                   | Level-1-260C-UNLIM   | -40 to 125   | LCEA                    | <a href="#">Samples</a> |
| LP2985AIM5X-2.8/NOPB | ACTIVE        | SOT-23       | DBV             | 5    | 3000        | Green (RoHS & no Sb/Br) | CU SN                   | Level-1-260C-UNLIM   | -40 to 125   | L0KA                    | <a href="#">Samples</a> |
| LP2985AIM5X-2.9/NOPB | ACTIVE        | SOT-23       | DBV             | 5    | 3000        | Green (RoHS & no Sb/Br) | CU SN                   | Level-1-260C-UNLIM   | -40 to 125   | LAXA                    | <a href="#">Samples</a> |
| LP2985AIM5X-3.0/NOPB | ACTIVE        | SOT-23       | DBV             | 5    | 3000        | Green (RoHS & no Sb/Br) | CU SN                   | Level-1-260C-UNLIM   | -40 to 125   | L0OA                    | <a href="#">Samples</a> |
| LP2985AIM5X-3.1/NOPB | ACTIVE        | SOT-23       | DBV             | 5    | 3000        | Green (RoHS & no Sb/Br) | CU SN                   | Level-1-260C-UNLIM   | -40 to 125   | L0PA                    | <a href="#">Samples</a> |
| LP2985AIM5X-3.3      | NRND          | SOT-23       | DBV             | 5    |             | TBD                     | Call TI                 | Call TI              | -40 to 125   | L0RA                    |                         |
| LP2985AIM5X-3.3/NOPB | ACTIVE        | SOT-23       | DBV             | 5    | 3000        | Green (RoHS & no Sb/Br) | CU SN                   | Level-1-260C-UNLIM   | -40 to 125   | L0RA                    | <a href="#">Samples</a> |
| LP2985AIM5X-3.6/NOPB | ACTIVE        | SOT-23       | DBV             | 5    | 3000        | Green (RoHS & no Sb/Br) | CU SN                   | Level-1-260C-UNLIM   | -40 to 125   | L0SA                    | <a href="#">Samples</a> |
| LP2985AIM5X-3.8/NOPB | ACTIVE        | SOT-23       | DBV             | 5    | 3000        | Green (RoHS & no Sb/Br) | CU SN                   | Level-1-260C-UNLIM   | -40 to 125   | L0YA                    | <a href="#">Samples</a> |
| LP2985AIM5X-4.0/NOPB | ACTIVE        | SOT-23       | DBV             | 5    | 3000        | Green (RoHS & no Sb/Br) | CU SN                   | Level-1-260C-UNLIM   | -40 to 125   | L0TA                    | <a href="#">Samples</a> |
| LP2985AIM5X-4.5/NOPB | ACTIVE        | SOT-23       | DBV             | 5    | 3000        | Green (RoHS & no Sb/Br) | CU SN                   | Level-1-260C-UNLIM   | -40 to 125   | LA7A                    | <a href="#">Samples</a> |
| LP2985AIM5X-5.0      | NRND          | SOT-23       | DBV             | 5    | 3000        | TBD                     | Call TI                 | Call TI              | -40 to 125   | L0UA                    |                         |
| LP2985AIM5X-5.0/NOPB | ACTIVE        | SOT-23       | DBV             | 5    | 3000        | Green (RoHS & no Sb/Br) | CU SN                   | Level-1-260C-UNLIM   | -40 to 125   | L0UA                    | <a href="#">Samples</a> |
| LP2985AIM5X-6.1/NOPB | ACTIVE        | SOT-23       | DBV             | 5    | 3000        | Green (RoHS & no Sb/Br) | CU SN                   | Level-1-260C-UNLIM   | -40 to 125   | LF6A                    | <a href="#">Samples</a> |
| LP2985AITL-3.3/NOPB  | LIFEBUY       | DSBGA        | YZR             | 5    | 250         | Green (RoHS & no Sb/Br) | SNAGCU                  | Level-1-260C-UNLIM   | -40 to 125   | 5                       |                         |
| LP2985AITLX-3.3/NOPB | LIFEBUY       | DSBGA        | YZR             | 5    | 3000        | Green (RoHS & no Sb/Br) | SNAGCU                  | Level-1-260C-UNLIM   |              | 5                       |                         |
| LP2985AITP-2.8/NOPB  | LIFEBUY       | DSBGA        | YPB             | 5    | 250         | Green (RoHS & no Sb/Br) | SNAGCU                  | Level-1-260C-UNLIM   | -40 to 125   | 5                       |                         |

| Orderable Device     | Status<br>(1) | Package Type | Package<br>Drawing | Pins | Package<br>Qty | Eco Plan<br>(2)            | Lead/Ball Finish<br>(6) | MSL Peak Temp<br>(3) | Op Temp (°C) | Device Marking<br>(4/5) | Samples |
|----------------------|---------------|--------------|--------------------|------|----------------|----------------------------|-------------------------|----------------------|--------------|-------------------------|---------|
| LP2985AITP-3.0/NOPB  | LIFEBUY       | DSBGA        | YPB                | 5    | 250            | Green (RoHS<br>& no Sb/Br) | SNAGCU                  | Level-1-260C-UNLIM   | -40 to 125   | 5                       |         |
| LP2985AITP-3.3/NOPB  | LIFEBUY       | DSBGA        | YPB                | 5    | 250            | Green (RoHS<br>& no Sb/Br) | SNAGCU                  | Level-1-260C-UNLIM   | -40 to 125   | 5                       |         |
| LP2985AITP-5.0/NOPB  | LIFEBUY       | DSBGA        | YPB                | 5    | 250            | Green (RoHS<br>& no Sb/Br) | SNAGCU                  | Level-1-260C-UNLIM   | -40 to 125   | 5                       |         |
| LP2985AITPX-2.5/NOPB | LIFEBUY       | DSBGA        | YPB                | 5    | 3000           | Green (RoHS<br>& no Sb/Br) | SNAGCU                  | Level-1-260C-UNLIM   |              | 5                       |         |
| LP2985AITPX-2.8/NOPB | LIFEBUY       | DSBGA        | YPB                | 5    | 3000           | Green (RoHS<br>& no Sb/Br) | SNAGCU                  | Level-1-260C-UNLIM   |              | 5                       |         |
| LP2985AITPX-3.0/NOPB | LIFEBUY       | DSBGA        | YPB                | 5    | 3000           | Green (RoHS<br>& no Sb/Br) | SNAGCU                  | Level-1-260C-UNLIM   | -40 to 125   | 5                       |         |
| LP2985AITPX-3.3/NOPB | LIFEBUY       | DSBGA        | YPB                | 5    | 3000           | Green (RoHS<br>& no Sb/Br) | SNAGCU                  | Level-1-260C-UNLIM   |              | 5                       |         |
| LP2985AITPX-5.0/NOPB | LIFEBUY       | DSBGA        | YPB                | 5    | 3000           | Green (RoHS<br>& no Sb/Br) | SNAGCU                  | Level-1-260C-UNLIM   |              | 5                       |         |
| LP2985IM5-2.5        | NRND          | SOT-23       | DBV                | 5    | 1000           | TBD                        | Call TI                 | Call TI              | -40 to 125   | LAUB                    |         |
| LP2985IM5-2.5/NOPB   | ACTIVE        | SOT-23       | DBV                | 5    | 1000           | Green (RoHS<br>& no Sb/Br) | CU SN                   | Level-1-260C-UNLIM   | -40 to 125   | LAUB                    | Samples |
| LP2985IM5-2.7/NOPB   | ACTIVE        | SOT-23       | DBV                | 5    | 1000           | Green (RoHS<br>& no Sb/Br) | CU SN                   | Level-1-260C-UNLIM   |              | LALB                    | Samples |
| LP2985IM5-2.8/NOPB   | ACTIVE        | SOT-23       | DBV                | 5    | 1000           | Green (RoHS<br>& no Sb/Br) | CU SN                   | Level-1-260C-UNLIM   | -40 to 125   | L0KB                    | Samples |
| LP2985IM5-2.9/NOPB   | ACTIVE        | SOT-23       | DBV                | 5    | 1000           | Green (RoHS<br>& no Sb/Br) | CU SN                   | Level-1-260C-UNLIM   | -40 to 125   | LAXB                    | Samples |
| LP2985IM5-3.0/NOPB   | ACTIVE        | SOT-23       | DBV                | 5    | 1000           | Green (RoHS<br>& no Sb/Br) | CU SN                   | Level-1-260C-UNLIM   | -40 to 125   | L0OB                    | Samples |
| LP2985IM5-3.1/NOPB   | ACTIVE        | SOT-23       | DBV                | 5    | 1000           | Green (RoHS<br>& no Sb/Br) | CU SN                   | Level-1-260C-UNLIM   | -40 to 125   | L0PB                    | Samples |
| LP2985IM5-3.2/NOPB   | ACTIVE        | SOT-23       | DBV                | 5    | 1000           | Green (RoHS<br>& no Sb/Br) | CU SN                   | Level-1-260C-UNLIM   | -40 to 125   | L0QB                    | Samples |
| LP2985IM5-3.3        | NRND          | SOT-23       | DBV                | 5    | 1000           | TBD                        | Call TI                 | Call TI              | -40 to 125   | L0RB                    |         |
| LP2985IM5-3.3/NOPB   | ACTIVE        | SOT-23       | DBV                | 5    | 1000           | Green (RoHS<br>& no Sb/Br) | CU SN                   | Level-1-260C-UNLIM   | -40 to 125   | L0RB                    | Samples |
| LP2985IM5-3.5/NOPB   | ACTIVE        | SOT-23       | DBV                | 5    | 1000           | Green (RoHS<br>& no Sb/Br) | CU SN                   | Level-1-260C-UNLIM   | -40 to 125   | LAIB                    | Samples |

| Orderable Device    | Status<br>(1) | Package Type | Package Drawing | Pins | Package Qty | Eco Plan<br>(2)         | Lead/Ball Finish<br>(6) | MSL Peak Temp<br>(3) | Op Temp (°C) | Device Marking<br>(4/5) | Samples                 |
|---------------------|---------------|--------------|-----------------|------|-------------|-------------------------|-------------------------|----------------------|--------------|-------------------------|-------------------------|
| LP2985IM5-3.6       | NRND          | SOT-23       | DBV             | 5    | 1000        | TBD                     | Call TI                 | Call TI              | -40 to 125   | L0SB                    |                         |
| LP2985IM5-3.6/NOPB  | ACTIVE        | SOT-23       | DBV             | 5    | 1000        | Green (RoHS & no Sb/Br) | CU SN                   | Level-1-260C-UNLIM   | -40 to 125   | L0SB                    | <a href="#">Samples</a> |
| LP2985IM5-3.8       | NRND          | SOT-23       | DBV             | 5    | 1000        | TBD                     | Call TI                 | Call TI              | -40 to 125   | L0YB                    |                         |
| LP2985IM5-3.8/NOPB  | ACTIVE        | SOT-23       | DBV             | 5    | 1000        | Green (RoHS & no Sb/Br) | CU SN                   | Level-1-260C-UNLIM   | -40 to 125   | L0YB                    | <a href="#">Samples</a> |
| LP2985IM5-4.0/NOPB  | ACTIVE        | SOT-23       | DBV             | 5    | 1000        | Green (RoHS & no Sb/Br) | CU SN                   | Level-1-260C-UNLIM   | -40 to 125   | L0TB                    | <a href="#">Samples</a> |
| LP2985IM5-4.5/NOPB  | ACTIVE        | SOT-23       | DBV             | 5    | 1000        | Green (RoHS & no Sb/Br) | CU SN                   | Level-1-260C-UNLIM   |              | LA7B                    | <a href="#">Samples</a> |
| LP2985IM5-5.0       | NRND          | SOT-23       | DBV             | 5    | 1000        | TBD                     | Call TI                 | Call TI              | -40 to 125   | L0UB                    |                         |
| LP2985IM5-5.0/NOPB  | ACTIVE        | SOT-23       | DBV             | 5    | 1000        | Green (RoHS & no Sb/Br) | CU SN                   | Level-1-260C-UNLIM   | -40 to 125   | L0UB                    | <a href="#">Samples</a> |
| LP2985IM5-5.7/NOPB  | ACTIVE        | SOT-23       | DBV             | 5    | 1000        | Green (RoHS & no Sb/Br) | CU SN                   | Level-1-260C-UNLIM   |              | LKTB                    | <a href="#">Samples</a> |
| LP2985IM5-6.1/NOPB  | ACTIVE        | SOT-23       | DBV             | 5    | 1000        | Green (RoHS & no Sb/Br) | CU SN                   | Level-1-260C-UNLIM   |              | LF6B                    | <a href="#">Samples</a> |
| LP2985IM5X-2.5/NOPB | ACTIVE        | SOT-23       | DBV             | 5    | 3000        | Green (RoHS & no Sb/Br) | CU SN                   | Level-1-260C-UNLIM   | -40 to 125   | LAUB                    | <a href="#">Samples</a> |
| LP2985IM5X-2.7/NOPB | ACTIVE        | SOT-23       | DBV             | 5    | 3000        | Green (RoHS & no Sb/Br) | CU SN                   | Level-1-260C-UNLIM   |              | LALB                    | <a href="#">Samples</a> |
| LP2985IM5X-2.8/NOPB | ACTIVE        | SOT-23       | DBV             | 5    | 3000        | Green (RoHS & no Sb/Br) | CU SN                   | Level-1-260C-UNLIM   | -40 to 125   | L0KB                    | <a href="#">Samples</a> |
| LP2985IM5X-3.0      | NRND          | SOT-23       | DBV             | 5    |             | TBD                     | Call TI                 | Call TI              | -40 to 125   |                         |                         |
| LP2985IM5X-3.0/NOPB | ACTIVE        | SOT-23       | DBV             | 5    | 3000        | Green (RoHS & no Sb/Br) | CU SN                   | Level-1-260C-UNLIM   | -40 to 125   | L0OB                    | <a href="#">Samples</a> |
| LP2985IM5X-3.3/NOPB | ACTIVE        | SOT-23       | DBV             | 5    | 3000        | Green (RoHS & no Sb/Br) | CU SN                   | Level-1-260C-UNLIM   | -40 to 125   | L0RB                    | <a href="#">Samples</a> |
| LP2985IM5X-3.6/NOPB | ACTIVE        | SOT-23       | DBV             | 5    | 3000        | Green (RoHS & no Sb/Br) | CU SN                   | Level-1-260C-UNLIM   | -40 to 125   | L0SB                    | <a href="#">Samples</a> |
| LP2985IM5X-4.0/NOPB | ACTIVE        | SOT-23       | DBV             | 5    | 3000        | Green (RoHS & no Sb/Br) | CU SN                   | Level-1-260C-UNLIM   | -40 to 125   | L0TB                    | <a href="#">Samples</a> |
| LP2985IM5X-4.5/NOPB | ACTIVE        | SOT-23       | DBV             | 5    | 3000        | Green (RoHS & no Sb/Br) | CU SN                   | Level-1-260C-UNLIM   |              | LA7B                    | <a href="#">Samples</a> |
| LP2985IM5X-5.0      | NRND          | SOT-23       | DBV             | 5    | 3000        | TBD                     | Call TI                 | Call TI              | -40 to 125   | L0UB                    |                         |

| Orderable Device    | Status<br>(1) | Package Type | Package Drawing | Pins | Package Qty | Eco Plan<br>(2)         | Lead/Ball Finish<br>(6) | MSL Peak Temp<br>(3) | Op Temp (°C) | Device Marking<br>(4/5) | Samples        |
|---------------------|---------------|--------------|-----------------|------|-------------|-------------------------|-------------------------|----------------------|--------------|-------------------------|----------------|
| LP2985IM5X-5.0/NOPB | ACTIVE        | SOT-23       | DBV             | 5    | 3000        | Green (RoHS & no Sb/Br) | CU SN                   | Level-1-260C-UNLIM   | -40 to 125   | LOUB                    | <b>Samples</b> |
| LP2985ITP-2.6/NOPB  | LIFEBUY       | DSBGA        | YPB             | 5    | 250         | Green (RoHS & no Sb/Br) | SNAGCU                  | Level-1-260C-UNLIM   | -40 to 125   | 5                       |                |
| LP2985ITP-2.7/NOPB  | LIFEBUY       | DSBGA        | YPB             | 5    | 250         | Green (RoHS & no Sb/Br) | SNAGCU                  | Level-1-260C-UNLIM   |              | 5                       |                |
| LP2985ITP-2.8/NOPB  | LIFEBUY       | DSBGA        | YPB             | 5    | 250         | Green (RoHS & no Sb/Br) | SNAGCU                  | Level-1-260C-UNLIM   | -40 to 125   | 5                       |                |
| LP2985ITP-3.0/NOPB  | LIFEBUY       | DSBGA        | YPB             | 5    | 250         | Green (RoHS & no Sb/Br) | SNAGCU                  | Level-1-260C-UNLIM   | -40 to 125   | 5                       |                |
| LP2985ITP-3.3/NOPB  | LIFEBUY       | DSBGA        | YPB             | 5    | 250         | Green (RoHS & no Sb/Br) | SNAGCU                  | Level-1-260C-UNLIM   | -40 to 125   | 5                       |                |
| LP2985ITP-5.0/NOPB  | LIFEBUY       | DSBGA        | YPB             | 5    | 250         | Green (RoHS & no Sb/Br) | SNAGCU                  | Level-1-260C-UNLIM   | -40 to 125   | 5                       |                |
| LP2985ITPX-3.0/NOPB | LIFEBUY       | DSBGA        | YPB             | 5    | 3000        | Green (RoHS & no Sb/Br) | SNAGCU                  | Level-1-260C-UNLIM   | -40 to 125   | 5                       |                |
| LP2985ITPX-3.3/NOPB | LIFEBUY       | DSBGA        | YPB             | 5    | 3000        | Green (RoHS & no Sb/Br) | SNAGCU                  | Level-1-260C-UNLIM   |              | 5                       |                |
| LP2985ITPX-5.0/NOPB | LIFEBUY       | DSBGA        | YPB             | 5    | 3000        | Green (RoHS & no Sb/Br) | SNAGCU                  | Level-1-260C-UNLIM   |              | 5                       |                |

(1) The marketing status values are defined as follows:

**ACTIVE:** Product device recommended for new designs.

**LIFEBUY:** TI has announced that the device will be discontinued, and a lifetime-buy period is in effect.

**NRND:** Not recommended for new designs. Device is in production to support existing customers, but TI does not recommend using this part in a new design.

**PREVIEW:** Device has been announced but is not in production. Samples may or may not be available.

**OBSELETE:** TI has discontinued the production of the device.

(2) Eco Plan - The planned eco-friendly classification: Pb-Free (RoHS), Pb-Free (RoHS Exempt), or Green (RoHS & no Sb/Br) - please check <http://www.ti.com/productcontent> for the latest availability information and additional product content details.

**TBD:** The Pb-Free/Green conversion plan has not been defined.

**Pb-Free (RoHS):** TI's terms "Lead-Free" or "Pb-Free" mean semiconductor products that are compatible with the current RoHS requirements for all 6 substances, including the requirement that lead not exceed 0.1% by weight in homogeneous materials. Where designed to be soldered at high temperatures, TI Pb-Free products are suitable for use in specified lead-free processes.

**Pb-Free (RoHS Exempt):** This component has a RoHS exemption for either 1) lead-based flip-chip solder bumps used between the die and package, or 2) lead-based die adhesive used between the die and leadframe. The component is otherwise considered Pb-Free (RoHS compatible) as defined above.

**Green (RoHS & no Sb/Br):** TI defines "Green" to mean Pb-Free (RoHS compatible), and free of Bromine (Br) and Antimony (Sb) based flame retardants (Br or Sb do not exceed 0.1% by weight in homogeneous material)

- (3) MSL, Peak Temp. - The Moisture Sensitivity Level rating according to the JEDEC industry standard classifications, and peak solder temperature.
- (4) There may be additional marking, which relates to the logo, the lot trace code information, or the environmental category on the device.
- (5) Multiple Device Markings will be inside parentheses. Only one Device Marking contained in parentheses and separated by a "-" will appear on a device. If a line is indented then it is a continuation of the previous line and the two combined represent the entire Device Marking for that device.
- (6) Lead/Ball Finish - Orderable Devices may have multiple material finish options. Finish options are separated by a vertical ruled line. Lead/Ball Finish values may wrap to two lines if the finish value exceeds the maximum column width.

**Important Information and Disclaimer:**The information provided on this page represents TI's knowledge and belief as of the date that it is provided. TI bases its knowledge and belief on information provided by third parties, and makes no representation or warranty as to the accuracy of such information. Efforts are underway to better integrate information from third parties. TI has taken and continues to take reasonable steps to provide representative and accurate information but may not have conducted destructive testing or chemical analysis on incoming materials and chemicals. TI and TI suppliers consider certain information to be proprietary, and thus CAS numbers and other limited information may not be available for release.

In no event shall TI's liability arising out of such information exceed the total purchase price of the TI part(s) at issue in this document sold by TI to Customer on an annual basis.

**TAPE AND REEL INFORMATION**

**QUADRANT ASSIGNMENTS FOR PIN 1 ORIENTATION IN TAPE**

\*All dimensions are nominal

| Device              | Package Type | Package Drawing | Pins | SPQ  | Reel Diameter (mm) | Reel Width W1 (mm) | A0 (mm) | B0 (mm) | K0 (mm) | P1 (mm) | W (mm) | Pin1 Quadrant |
|---------------------|--------------|-----------------|------|------|--------------------|--------------------|---------|---------|---------|---------|--------|---------------|
| LP2985AIM5-2.5/NOPB | SOT-23       | DBV             | 5    | 1000 | 178.0              | 8.4                | 3.2     | 3.2     | 1.4     | 4.0     | 8.0    | Q3            |
| LP2985AIM5-2.7/NOPB | SOT-23       | DBV             | 5    | 1000 | 178.0              | 8.4                | 3.2     | 3.2     | 1.4     | 4.0     | 8.0    | Q3            |
| LP2985AIM5-2.8      | SOT-23       | DBV             | 5    | 1000 | 178.0              | 8.4                | 3.2     | 3.2     | 1.4     | 4.0     | 8.0    | Q3            |
| LP2985AIM5-2.8/NOPB | SOT-23       | DBV             | 5    | 1000 | 178.0              | 8.4                | 3.2     | 3.2     | 1.4     | 4.0     | 8.0    | Q3            |
| LP2985AIM5-2.9/NOPB | SOT-23       | DBV             | 5    | 1000 | 178.0              | 8.4                | 3.2     | 3.2     | 1.4     | 4.0     | 8.0    | Q3            |
| LP2985AIM5-3.0      | SOT-23       | DBV             | 5    | 1000 | 178.0              | 8.4                | 3.2     | 3.2     | 1.4     | 4.0     | 8.0    | Q3            |
| LP2985AIM5-3.0/NOPB | SOT-23       | DBV             | 5    | 1000 | 178.0              | 8.4                | 3.2     | 3.2     | 1.4     | 4.0     | 8.0    | Q3            |
| LP2985AIM5-3.1/NOPB | SOT-23       | DBV             | 5    | 1000 | 178.0              | 8.4                | 3.2     | 3.2     | 1.4     | 4.0     | 8.0    | Q3            |
| LP2985AIM5-3.3      | SOT-23       | DBV             | 5    | 1000 | 178.0              | 8.4                | 3.2     | 3.2     | 1.4     | 4.0     | 8.0    | Q3            |
| LP2985AIM5-3.3/NOPB | SOT-23       | DBV             | 5    | 1000 | 178.0              | 8.4                | 3.2     | 3.2     | 1.4     | 4.0     | 8.0    | Q3            |
| LP2985AIM5-3.6      | SOT-23       | DBV             | 5    | 1000 | 178.0              | 8.4                | 3.2     | 3.2     | 1.4     | 4.0     | 8.0    | Q3            |
| LP2985AIM5-3.6/NOPB | SOT-23       | DBV             | 5    | 1000 | 178.0              | 8.4                | 3.2     | 3.2     | 1.4     | 4.0     | 8.0    | Q3            |
| LP2985AIM5-3.8/NOPB | SOT-23       | DBV             | 5    | 1000 | 178.0              | 8.4                | 3.2     | 3.2     | 1.4     | 4.0     | 8.0    | Q3            |
| LP2985AIM5-4.0/NOPB | SOT-23       | DBV             | 5    | 1000 | 178.0              | 8.4                | 3.2     | 3.2     | 1.4     | 4.0     | 8.0    | Q3            |
| LP2985AIM5-4.5/NOPB | SOT-23       | DBV             | 5    | 1000 | 178.0              | 8.4                | 3.2     | 3.2     | 1.4     | 4.0     | 8.0    | Q3            |
| LP2985AIM5-5.0      | SOT-23       | DBV             | 5    | 1000 | 178.0              | 8.4                | 3.2     | 3.2     | 1.4     | 4.0     | 8.0    | Q3            |
| LP2985AIM5-5.0/NOPB | SOT-23       | DBV             | 5    | 1000 | 178.0              | 8.4                | 3.2     | 3.2     | 1.4     | 4.0     | 8.0    | Q3            |
| LP2985AIM5-5.7/NOPB | SOT-23       | DBV             | 5    | 1000 | 178.0              | 8.4                | 3.2     | 3.2     | 1.4     | 4.0     | 8.0    | Q3            |

| Device               | Package Type | Package Drawing | Pins | SPQ  | Reel Diameter (mm) | Reel Width W1 (mm) | A0 (mm) | B0 (mm) | K0 (mm) | P1 (mm) | W (mm) | Pin1 Quadrant |
|----------------------|--------------|-----------------|------|------|--------------------|--------------------|---------|---------|---------|---------|--------|---------------|
| LP2985AIM5-6.1/NOPB  | SOT-23       | DBV             | 5    | 1000 | 178.0              | 8.4                | 3.2     | 3.2     | 1.4     | 4.0     | 8.0    | Q3            |
| LP2985AIM5X-2.5      | SOT-23       | DBV             | 5    | 3000 | 178.0              | 8.4                | 3.2     | 3.2     | 1.4     | 4.0     | 8.0    | Q3            |
| LP2985AIM5X-2.5/NOPB | SOT-23       | DBV             | 5    | 3000 | 178.0              | 8.4                | 3.2     | 3.2     | 1.4     | 4.0     | 8.0    | Q3            |
| LP2985AIM5X-2.6/NOPB | SOT-23       | DBV             | 5    | 3000 | 178.0              | 8.4                | 3.2     | 3.2     | 1.4     | 4.0     | 8.0    | Q3            |
| LP2985AIM5X-2.8/NOPB | SOT-23       | DBV             | 5    | 3000 | 178.0              | 8.4                | 3.2     | 3.2     | 1.4     | 4.0     | 8.0    | Q3            |
| LP2985AIM5X-2.9/NOPB | SOT-23       | DBV             | 5    | 3000 | 178.0              | 8.4                | 3.2     | 3.2     | 1.4     | 4.0     | 8.0    | Q3            |
| LP2985AIM5X-3.0/NOPB | SOT-23       | DBV             | 5    | 3000 | 178.0              | 8.4                | 3.2     | 3.2     | 1.4     | 4.0     | 8.0    | Q3            |
| LP2985AIM5X-3.1/NOPB | SOT-23       | DBV             | 5    | 3000 | 178.0              | 8.4                | 3.2     | 3.2     | 1.4     | 4.0     | 8.0    | Q3            |
| LP2985AIM5X-3.3/NOPB | SOT-23       | DBV             | 5    | 3000 | 178.0              | 8.4                | 3.2     | 3.2     | 1.4     | 4.0     | 8.0    | Q3            |
| LP2985AIM5X-3.6/NOPB | SOT-23       | DBV             | 5    | 3000 | 178.0              | 8.4                | 3.2     | 3.2     | 1.4     | 4.0     | 8.0    | Q3            |
| LP2985AIM5X-3.8/NOPB | SOT-23       | DBV             | 5    | 3000 | 178.0              | 8.4                | 3.2     | 3.2     | 1.4     | 4.0     | 8.0    | Q3            |
| LP2985AIM5X-4.0/NOPB | SOT-23       | DBV             | 5    | 3000 | 178.0              | 8.4                | 3.2     | 3.2     | 1.4     | 4.0     | 8.0    | Q3            |
| LP2985AIM5X-4.5/NOPB | SOT-23       | DBV             | 5    | 3000 | 178.0              | 8.4                | 3.2     | 3.2     | 1.4     | 4.0     | 8.0    | Q3            |
| LP2985AIM5X-5.0      | SOT-23       | DBV             | 5    | 3000 | 178.0              | 8.4                | 3.2     | 3.2     | 1.4     | 4.0     | 8.0    | Q3            |
| LP2985AIM5X-5.0/NOPB | SOT-23       | DBV             | 5    | 3000 | 178.0              | 8.4                | 3.2     | 3.2     | 1.4     | 4.0     | 8.0    | Q3            |
| LP2985AIM5X-6.1/NOPB | SOT-23       | DBV             | 5    | 3000 | 178.0              | 8.4                | 3.2     | 3.2     | 1.4     | 4.0     | 8.0    | Q3            |
| LP2985AITL-3.3/NOPB  | DSBGA        | YZR             | 5    | 250  | 178.0              | 8.4                | 1.14    | 1.47    | 0.76    | 4.0     | 8.0    | Q1            |
| LP2985AITLX-3.3/NOPB | DSBGA        | YZR             | 5    | 3000 | 178.0              | 8.4                | 1.14    | 1.47    | 0.76    | 4.0     | 8.0    | Q1            |
| LP2985AITP-2.8/NOPB  | DSBGA        | YPB             | 5    | 250  | 178.0              | 8.4                | 1.02    | 1.19    | 0.66    | 4.0     | 8.0    | Q1            |
| LP2985AITP-3.0/NOPB  | DSBGA        | YPB             | 5    | 250  | 178.0              | 8.4                | 1.02    | 1.19    | 0.66    | 4.0     | 8.0    | Q1            |
| LP2985AITP-3.3/NOPB  | DSBGA        | YPB             | 5    | 250  | 178.0              | 8.4                | 1.02    | 1.19    | 0.66    | 4.0     | 8.0    | Q1            |
| LP2985AITP-5.0/NOPB  | DSBGA        | YPB             | 5    | 250  | 178.0              | 8.4                | 1.02    | 1.19    | 0.66    | 4.0     | 8.0    | Q1            |
| LP2985AITPX-2.5/NOPB | DSBGA        | YPB             | 5    | 3000 | 178.0              | 8.4                | 1.02    | 1.19    | 0.66    | 4.0     | 8.0    | Q1            |
| LP2985AITPX-2.8/NOPB | DSBGA        | YPB             | 5    | 3000 | 178.0              | 8.4                | 1.02    | 1.19    | 0.66    | 4.0     | 8.0    | Q1            |
| LP2985AITPX-3.0/NOPB | DSBGA        | YPB             | 5    | 3000 | 178.0              | 8.4                | 1.02    | 1.19    | 0.66    | 4.0     | 8.0    | Q1            |
| LP2985AITPX-3.3/NOPB | DSBGA        | YPB             | 5    | 3000 | 178.0              | 8.4                | 1.02    | 1.19    | 0.66    | 4.0     | 8.0    | Q1            |
| LP2985AITPX-5.0/NOPB | DSBGA        | YPB             | 5    | 3000 | 178.0              | 8.4                | 1.02    | 1.19    | 0.66    | 4.0     | 8.0    | Q1            |
| LP2985IM5-2.5        | SOT-23       | DBV             | 5    | 1000 | 178.0              | 8.4                | 3.2     | 3.2     | 1.4     | 4.0     | 8.0    | Q3            |
| LP2985IM5-2.5/NOPB   | SOT-23       | DBV             | 5    | 1000 | 178.0              | 8.4                | 3.2     | 3.2     | 1.4     | 4.0     | 8.0    | Q3            |
| LP2985IM5-2.7/NOPB   | SOT-23       | DBV             | 5    | 1000 | 178.0              | 8.4                | 3.2     | 3.2     | 1.4     | 4.0     | 8.0    | Q3            |
| LP2985IM5-2.8/NOPB   | SOT-23       | DBV             | 5    | 1000 | 178.0              | 8.4                | 3.2     | 3.2     | 1.4     | 4.0     | 8.0    | Q3            |
| LP2985IM5-2.9/NOPB   | SOT-23       | DBV             | 5    | 1000 | 178.0              | 8.4                | 3.2     | 3.2     | 1.4     | 4.0     | 8.0    | Q3            |
| LP2985IM5-3.0/NOPB   | SOT-23       | DBV             | 5    | 1000 | 178.0              | 8.4                | 3.2     | 3.2     | 1.4     | 4.0     | 8.0    | Q3            |
| LP2985IM5-3.1/NOPB   | SOT-23       | DBV             | 5    | 1000 | 178.0              | 8.4                | 3.2     | 3.2     | 1.4     | 4.0     | 8.0    | Q3            |
| LP2985IM5-3.2/NOPB   | SOT-23       | DBV             | 5    | 1000 | 178.0              | 8.4                | 3.2     | 3.2     | 1.4     | 4.0     | 8.0    | Q3            |
| LP2985IM5-3.3        | SOT-23       | DBV             | 5    | 1000 | 178.0              | 8.4                | 3.2     | 3.2     | 1.4     | 4.0     | 8.0    | Q3            |
| LP2985IM5-3.3/NOPB   | SOT-23       | DBV             | 5    | 1000 | 178.0              | 8.4                | 3.2     | 3.2     | 1.4     | 4.0     | 8.0    | Q3            |
| LP2985IM5-3.5/NOPB   | SOT-23       | DBV             | 5    | 1000 | 178.0              | 8.4                | 3.2     | 3.2     | 1.4     | 4.0     | 8.0    | Q3            |
| LP2985IM5-3.6        | SOT-23       | DBV             | 5    | 1000 | 178.0              | 8.4                | 3.2     | 3.2     | 1.4     | 4.0     | 8.0    | Q3            |
| LP2985IM5-3.6/NOPB   | SOT-23       | DBV             | 5    | 1000 | 178.0              | 8.4                | 3.2     | 3.2     | 1.4     | 4.0     | 8.0    | Q3            |
| LP2985IM5-3.8        | SOT-23       | DBV             | 5    | 1000 | 178.0              | 8.4                | 3.2     | 3.2     | 1.4     | 4.0     | 8.0    | Q3            |
| LP2985IM5-3.8/NOPB   | SOT-23       | DBV             | 5    | 1000 | 178.0              | 8.4                | 3.2     | 3.2     | 1.4     | 4.0     | 8.0    | Q3            |
| LP2985IM5-4.0/NOPB   | SOT-23       | DBV             | 5    | 1000 | 178.0              | 8.4                | 3.2     | 3.2     | 1.4     | 4.0     | 8.0    | Q3            |



| Device              | Package Type | Package Drawing | Pins | SPQ  | Reel Diameter (mm) | Reel Width W1 (mm) | A0 (mm) | B0 (mm) | K0 (mm) | P1 (mm) | W (mm) | Pin1 Quadrant |
|---------------------|--------------|-----------------|------|------|--------------------|--------------------|---------|---------|---------|---------|--------|---------------|
| LP2985IM5-4.5/NOPB  | SOT-23       | DBV             | 5    | 1000 | 178.0              | 8.4                | 3.2     | 3.2     | 1.4     | 4.0     | 8.0    | Q3            |
| LP2985IM5-5.0       | SOT-23       | DBV             | 5    | 1000 | 178.0              | 8.4                | 3.2     | 3.2     | 1.4     | 4.0     | 8.0    | Q3            |
| LP2985IM5-5.0/NOPB  | SOT-23       | DBV             | 5    | 1000 | 178.0              | 8.4                | 3.2     | 3.2     | 1.4     | 4.0     | 8.0    | Q3            |
| LP2985IM5-5.7/NOPB  | SOT-23       | DBV             | 5    | 1000 | 178.0              | 8.4                | 3.2     | 3.2     | 1.4     | 4.0     | 8.0    | Q3            |
| LP2985IM5-6.1/NOPB  | SOT-23       | DBV             | 5    | 1000 | 178.0              | 8.4                | 3.2     | 3.2     | 1.4     | 4.0     | 8.0    | Q3            |
| LP2985IM5X-2.5/NOPB | SOT-23       | DBV             | 5    | 3000 | 178.0              | 8.4                | 3.2     | 3.2     | 1.4     | 4.0     | 8.0    | Q3            |
| LP2985IM5X-2.7/NOPB | SOT-23       | DBV             | 5    | 3000 | 178.0              | 8.4                | 3.2     | 3.2     | 1.4     | 4.0     | 8.0    | Q3            |
| LP2985IM5X-2.8/NOPB | SOT-23       | DBV             | 5    | 3000 | 178.0              | 8.4                | 3.2     | 3.2     | 1.4     | 4.0     | 8.0    | Q3            |
| LP2985IM5X-3.0/NOPB | SOT-23       | DBV             | 5    | 3000 | 178.0              | 8.4                | 3.2     | 3.2     | 1.4     | 4.0     | 8.0    | Q3            |
| LP2985IM5X-3.3/NOPB | SOT-23       | DBV             | 5    | 3000 | 178.0              | 8.4                | 3.2     | 3.2     | 1.4     | 4.0     | 8.0    | Q3            |
| LP2985IM5X-3.6/NOPB | SOT-23       | DBV             | 5    | 3000 | 178.0              | 8.4                | 3.2     | 3.2     | 1.4     | 4.0     | 8.0    | Q3            |
| LP2985IM5X-4.0/NOPB | SOT-23       | DBV             | 5    | 3000 | 178.0              | 8.4                | 3.2     | 3.2     | 1.4     | 4.0     | 8.0    | Q3            |
| LP2985IM5X-4.5/NOPB | SOT-23       | DBV             | 5    | 3000 | 178.0              | 8.4                | 3.2     | 3.2     | 1.4     | 4.0     | 8.0    | Q3            |
| LP2985IM5X-5.0      | SOT-23       | DBV             | 5    | 3000 | 178.0              | 8.4                | 3.2     | 3.2     | 1.4     | 4.0     | 8.0    | Q3            |
| LP2985IM5X-5.0/NOPB | SOT-23       | DBV             | 5    | 3000 | 178.0              | 8.4                | 3.2     | 3.2     | 1.4     | 4.0     | 8.0    | Q3            |
| LP2985ITP-2.6/NOPB  | DSBGA        | YPB             | 5    | 250  | 178.0              | 8.4                | 1.02    | 1.19    | 0.66    | 4.0     | 8.0    | Q1            |
| LP2985ITP-2.7/NOPB  | DSBGA        | YPB             | 5    | 250  | 178.0              | 8.4                | 1.02    | 1.19    | 0.66    | 4.0     | 8.0    | Q1            |
| LP2985ITP-2.8/NOPB  | DSBGA        | YPB             | 5    | 250  | 178.0              | 8.4                | 1.02    | 1.19    | 0.66    | 4.0     | 8.0    | Q1            |
| LP2985ITP-3.0/NOPB  | DSBGA        | YPB             | 5    | 250  | 178.0              | 8.4                | 1.02    | 1.19    | 0.66    | 4.0     | 8.0    | Q1            |
| LP2985ITP-3.3/NOPB  | DSBGA        | YPB             | 5    | 250  | 178.0              | 8.4                | 1.02    | 1.19    | 0.66    | 4.0     | 8.0    | Q1            |
| LP2985ITP-5.0/NOPB  | DSBGA        | YPB             | 5    | 250  | 178.0              | 8.4                | 1.02    | 1.19    | 0.66    | 4.0     | 8.0    | Q1            |
| LP2985ITPX-3.0/NOPB | DSBGA        | YPB             | 5    | 3000 | 178.0              | 8.4                | 1.02    | 1.19    | 0.66    | 4.0     | 8.0    | Q1            |
| LP2985ITPX-3.3/NOPB | DSBGA        | YPB             | 5    | 3000 | 178.0              | 8.4                | 1.02    | 1.19    | 0.66    | 4.0     | 8.0    | Q1            |
| LP2985ITPX-5.0/NOPB | DSBGA        | YPB             | 5    | 3000 | 178.0              | 8.4                | 1.02    | 1.19    | 0.66    | 4.0     | 8.0    | Q1            |

**TAPE AND REEL BOX DIMENSIONS**

\*All dimensions are nominal

| Device              | Package Type | Package Drawing | Pins | SPQ  | Length (mm) | Width (mm) | Height (mm) |
|---------------------|--------------|-----------------|------|------|-------------|------------|-------------|
| LP2985AIM5-2.5/NOPB | SOT-23       | DBV             | 5    | 1000 | 210.0       | 185.0      | 35.0        |
| LP2985AIM5-2.7/NOPB | SOT-23       | DBV             | 5    | 1000 | 210.0       | 185.0      | 35.0        |
| LP2985AIM5-2.8      | SOT-23       | DBV             | 5    | 1000 | 210.0       | 185.0      | 35.0        |
| LP2985AIM5-2.8/NOPB | SOT-23       | DBV             | 5    | 1000 | 210.0       | 185.0      | 35.0        |
| LP2985AIM5-2.9/NOPB | SOT-23       | DBV             | 5    | 1000 | 210.0       | 185.0      | 35.0        |
| LP2985AIM5-3.0      | SOT-23       | DBV             | 5    | 1000 | 210.0       | 185.0      | 35.0        |
| LP2985AIM5-3.0/NOPB | SOT-23       | DBV             | 5    | 1000 | 210.0       | 185.0      | 35.0        |
| LP2985AIM5-3.1/NOPB | SOT-23       | DBV             | 5    | 1000 | 210.0       | 185.0      | 35.0        |
| LP2985AIM5-3.3      | SOT-23       | DBV             | 5    | 1000 | 210.0       | 185.0      | 35.0        |
| LP2985AIM5-3.3/NOPB | SOT-23       | DBV             | 5    | 1000 | 210.0       | 185.0      | 35.0        |
| LP2985AIM5-3.6      | SOT-23       | DBV             | 5    | 1000 | 210.0       | 185.0      | 35.0        |
| LP2985AIM5-3.6/NOPB | SOT-23       | DBV             | 5    | 1000 | 210.0       | 185.0      | 35.0        |
| LP2985AIM5-3.8/NOPB | SOT-23       | DBV             | 5    | 1000 | 210.0       | 185.0      | 35.0        |
| LP2985AIM5-4.0/NOPB | SOT-23       | DBV             | 5    | 1000 | 210.0       | 185.0      | 35.0        |
| LP2985AIM5-4.5/NOPB | SOT-23       | DBV             | 5    | 1000 | 210.0       | 185.0      | 35.0        |
| LP2985AIM5-5.0      | SOT-23       | DBV             | 5    | 1000 | 210.0       | 185.0      | 35.0        |
| LP2985AIM5-5.0/NOPB | SOT-23       | DBV             | 5    | 1000 | 210.0       | 185.0      | 35.0        |
| LP2985AIM5-5.7/NOPB | SOT-23       | DBV             | 5    | 1000 | 210.0       | 185.0      | 35.0        |
| LP2985AIM5-6.1/NOPB | SOT-23       | DBV             | 5    | 1000 | 210.0       | 185.0      | 35.0        |
| LP2985AIM5X-2.5     | SOT-23       | DBV             | 5    | 3000 | 210.0       | 185.0      | 35.0        |

| Device               | Package Type | Package Drawing | Pins | SPQ  | Length (mm) | Width (mm) | Height (mm) |
|----------------------|--------------|-----------------|------|------|-------------|------------|-------------|
| LP2985AIM5X-2.5/NOPB | SOT-23       | DBV             | 5    | 3000 | 210.0       | 185.0      | 35.0        |
| LP2985AIM5X-2.6/NOPB | SOT-23       | DBV             | 5    | 3000 | 210.0       | 185.0      | 35.0        |
| LP2985AIM5X-2.8/NOPB | SOT-23       | DBV             | 5    | 3000 | 210.0       | 185.0      | 35.0        |
| LP2985AIM5X-2.9/NOPB | SOT-23       | DBV             | 5    | 3000 | 210.0       | 185.0      | 35.0        |
| LP2985AIM5X-3.0/NOPB | SOT-23       | DBV             | 5    | 3000 | 210.0       | 185.0      | 35.0        |
| LP2985AIM5X-3.1/NOPB | SOT-23       | DBV             | 5    | 3000 | 210.0       | 185.0      | 35.0        |
| LP2985AIM5X-3.3/NOPB | SOT-23       | DBV             | 5    | 3000 | 210.0       | 185.0      | 35.0        |
| LP2985AIM5X-3.6/NOPB | SOT-23       | DBV             | 5    | 3000 | 210.0       | 185.0      | 35.0        |
| LP2985AIM5X-3.8/NOPB | SOT-23       | DBV             | 5    | 3000 | 210.0       | 185.0      | 35.0        |
| LP2985AIM5X-4.0/NOPB | SOT-23       | DBV             | 5    | 3000 | 210.0       | 185.0      | 35.0        |
| LP2985AIM5X-4.5/NOPB | SOT-23       | DBV             | 5    | 3000 | 210.0       | 185.0      | 35.0        |
| LP2985AIM5X-5.0      | SOT-23       | DBV             | 5    | 3000 | 210.0       | 185.0      | 35.0        |
| LP2985AIM5X-5.0/NOPB | SOT-23       | DBV             | 5    | 3000 | 210.0       | 185.0      | 35.0        |
| LP2985AIM5X-6.1/NOPB | SOT-23       | DBV             | 5    | 3000 | 210.0       | 185.0      | 35.0        |
| LP2985AITL-3.3/NOPB  | DSBGA        | YZR             | 5    | 250  | 210.0       | 185.0      | 35.0        |
| LP2985AITLX-3.3/NOPB | DSBGA        | YZR             | 5    | 3000 | 210.0       | 185.0      | 35.0        |
| LP2985AITP-2.8/NOPB  | DSBGA        | YPB             | 5    | 250  | 210.0       | 185.0      | 35.0        |
| LP2985AITP-3.0/NOPB  | DSBGA        | YPB             | 5    | 250  | 210.0       | 185.0      | 35.0        |
| LP2985AITP-3.3/NOPB  | DSBGA        | YPB             | 5    | 250  | 210.0       | 185.0      | 35.0        |
| LP2985AITP-5.0/NOPB  | DSBGA        | YPB             | 5    | 250  | 210.0       | 185.0      | 35.0        |
| LP2985AITPX-2.5/NOPB | DSBGA        | YPB             | 5    | 3000 | 210.0       | 185.0      | 35.0        |
| LP2985AITPX-2.8/NOPB | DSBGA        | YPB             | 5    | 3000 | 210.0       | 185.0      | 35.0        |
| LP2985AITPX-3.0/NOPB | DSBGA        | YPB             | 5    | 3000 | 210.0       | 185.0      | 35.0        |
| LP2985AITPX-3.3/NOPB | DSBGA        | YPB             | 5    | 3000 | 210.0       | 185.0      | 35.0        |
| LP2985AITPX-5.0/NOPB | DSBGA        | YPB             | 5    | 3000 | 210.0       | 185.0      | 35.0        |
| LP2985IM5-2.5        | SOT-23       | DBV             | 5    | 1000 | 210.0       | 185.0      | 35.0        |
| LP2985IM5-2.5/NOPB   | SOT-23       | DBV             | 5    | 1000 | 210.0       | 185.0      | 35.0        |
| LP2985IM5-2.7/NOPB   | SOT-23       | DBV             | 5    | 1000 | 210.0       | 185.0      | 35.0        |
| LP2985IM5-2.8/NOPB   | SOT-23       | DBV             | 5    | 1000 | 210.0       | 185.0      | 35.0        |
| LP2985IM5-2.9/NOPB   | SOT-23       | DBV             | 5    | 1000 | 210.0       | 185.0      | 35.0        |
| LP2985IM5-3.0/NOPB   | SOT-23       | DBV             | 5    | 1000 | 210.0       | 185.0      | 35.0        |
| LP2985IM5-3.1/NOPB   | SOT-23       | DBV             | 5    | 1000 | 210.0       | 185.0      | 35.0        |
| LP2985IM5-3.2/NOPB   | SOT-23       | DBV             | 5    | 1000 | 210.0       | 185.0      | 35.0        |
| LP2985IM5-3.3        | SOT-23       | DBV             | 5    | 1000 | 210.0       | 185.0      | 35.0        |
| LP2985IM5-3.3/NOPB   | SOT-23       | DBV             | 5    | 1000 | 210.0       | 185.0      | 35.0        |
| LP2985IM5-3.5/NOPB   | SOT-23       | DBV             | 5    | 1000 | 210.0       | 185.0      | 35.0        |
| LP2985IM5-3.6        | SOT-23       | DBV             | 5    | 1000 | 210.0       | 185.0      | 35.0        |
| LP2985IM5-3.6/NOPB   | SOT-23       | DBV             | 5    | 1000 | 210.0       | 185.0      | 35.0        |
| LP2985IM5-3.8        | SOT-23       | DBV             | 5    | 1000 | 210.0       | 185.0      | 35.0        |
| LP2985IM5-3.8/NOPB   | SOT-23       | DBV             | 5    | 1000 | 210.0       | 185.0      | 35.0        |
| LP2985IM5-4.0/NOPB   | SOT-23       | DBV             | 5    | 1000 | 210.0       | 185.0      | 35.0        |
| LP2985IM5-4.5/NOPB   | SOT-23       | DBV             | 5    | 1000 | 210.0       | 185.0      | 35.0        |
| LP2985IM5-5.0        | SOT-23       | DBV             | 5    | 1000 | 210.0       | 185.0      | 35.0        |
| LP2985IM5-5.0/NOPB   | SOT-23       | DBV             | 5    | 1000 | 210.0       | 185.0      | 35.0        |

| Device              | Package Type | Package Drawing | Pins | SPQ  | Length (mm) | Width (mm) | Height (mm) |
|---------------------|--------------|-----------------|------|------|-------------|------------|-------------|
| LP2985IM5-5.7/NOPB  | SOT-23       | DBV             | 5    | 1000 | 210.0       | 185.0      | 35.0        |
| LP2985IM5-6.1/NOPB  | SOT-23       | DBV             | 5    | 1000 | 210.0       | 185.0      | 35.0        |
| LP2985IM5X-2.5/NOPB | SOT-23       | DBV             | 5    | 3000 | 210.0       | 185.0      | 35.0        |
| LP2985IM5X-2.7/NOPB | SOT-23       | DBV             | 5    | 3000 | 210.0       | 185.0      | 35.0        |
| LP2985IM5X-2.8/NOPB | SOT-23       | DBV             | 5    | 3000 | 210.0       | 185.0      | 35.0        |
| LP2985IM5X-3.0/NOPB | SOT-23       | DBV             | 5    | 3000 | 210.0       | 185.0      | 35.0        |
| LP2985IM5X-3.3/NOPB | SOT-23       | DBV             | 5    | 3000 | 210.0       | 185.0      | 35.0        |
| LP2985IM5X-3.6/NOPB | SOT-23       | DBV             | 5    | 3000 | 210.0       | 185.0      | 35.0        |
| LP2985IM5X-4.0/NOPB | SOT-23       | DBV             | 5    | 3000 | 210.0       | 185.0      | 35.0        |
| LP2985IM5X-4.5/NOPB | SOT-23       | DBV             | 5    | 3000 | 210.0       | 185.0      | 35.0        |
| LP2985IM5X-5.0      | SOT-23       | DBV             | 5    | 3000 | 210.0       | 185.0      | 35.0        |
| LP2985IM5X-5.0/NOPB | SOT-23       | DBV             | 5    | 3000 | 210.0       | 185.0      | 35.0        |
| LP2985ITP-2.6/NOPB  | DSBGA        | YPB             | 5    | 250  | 210.0       | 185.0      | 35.0        |
| LP2985ITP-2.7/NOPB  | DSBGA        | YPB             | 5    | 250  | 210.0       | 185.0      | 35.0        |
| LP2985ITP-2.8/NOPB  | DSBGA        | YPB             | 5    | 250  | 210.0       | 185.0      | 35.0        |
| LP2985ITP-3.0/NOPB  | DSBGA        | YPB             | 5    | 250  | 210.0       | 185.0      | 35.0        |
| LP2985ITP-3.3/NOPB  | DSBGA        | YPB             | 5    | 250  | 210.0       | 185.0      | 35.0        |
| LP2985ITP-5.0/NOPB  | DSBGA        | YPB             | 5    | 250  | 210.0       | 185.0      | 35.0        |
| LP2985ITPX-3.0/NOPB | DSBGA        | YPB             | 5    | 3000 | 210.0       | 185.0      | 35.0        |
| LP2985ITPX-3.3/NOPB | DSBGA        | YPB             | 5    | 3000 | 210.0       | 185.0      | 35.0        |
| LP2985ITPX-5.0/NOPB | DSBGA        | YPB             | 5    | 3000 | 210.0       | 185.0      | 35.0        |

DBV (R-PDSO-G5)

PLASTIC SMALL-OUTLINE PACKAGE

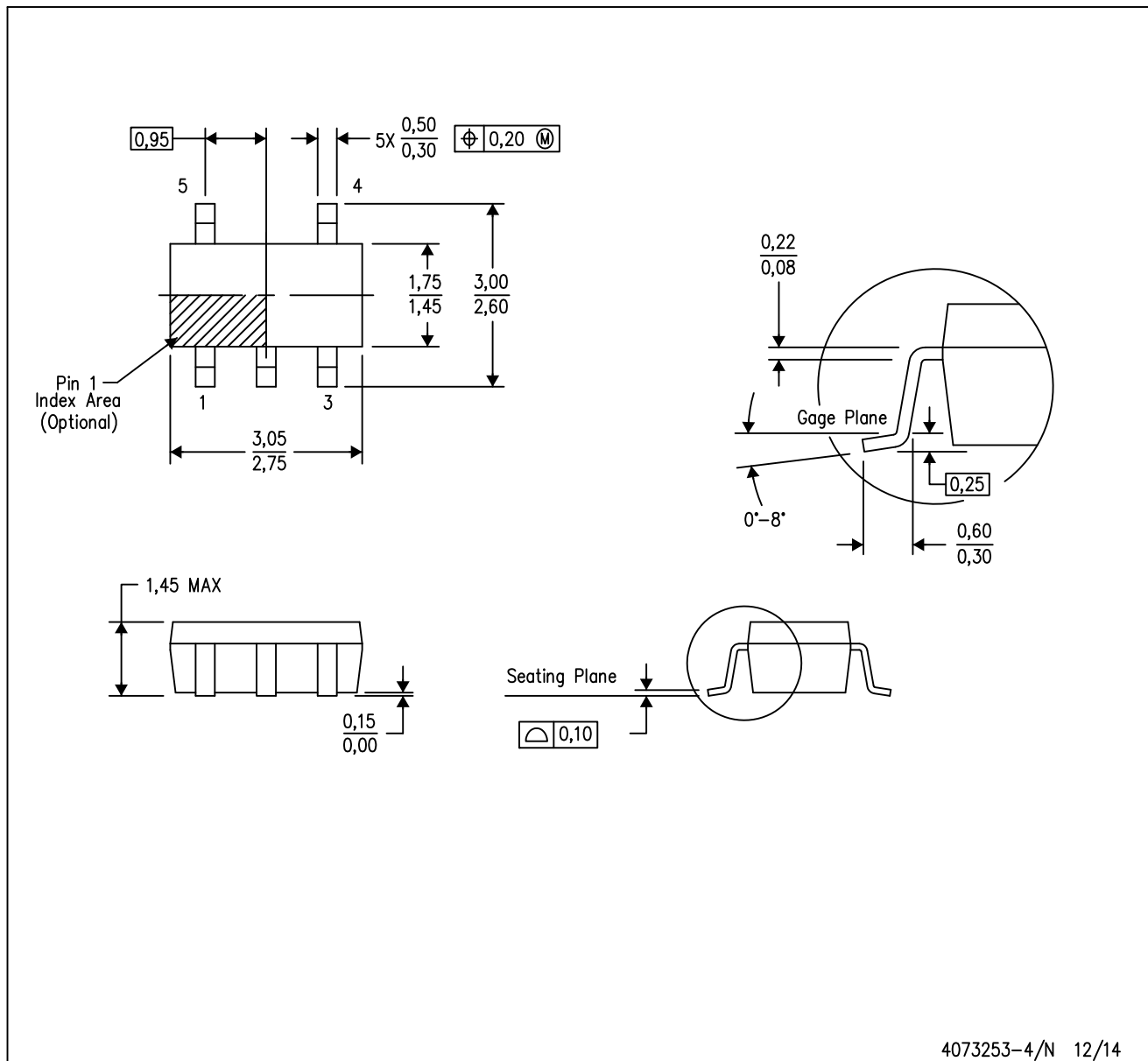

- NOTES:
- A. All linear dimensions are in millimeters.
  - B. This drawing is subject to change without notice.
  - C. Body dimensions do not include mold flash or protrusion. Mold flash and protrusion shall not exceed 0.15 per side.
  - D. Falls within JEDEC MO-178 Variation AA.

DBV (R-PDSO-G5)

PLASTIC SMALL OUTLINE



- NOTES:
- A. All linear dimensions are in millimeters.
  - B. This drawing is subject to change without notice.
  - C. Customers should place a note on the circuit board fabrication drawing not to alter the center solder mask defined pad.
  - D. Publication IPC-7351 is recommended for alternate designs.
  - E. Laser cutting apertures with trapezoidal walls and also rounding corners will offer better paste release. Customers should contact their board assembly site for stencil design recommendations. Example stencil design based on a 50% volumetric metal load solder paste. Refer to IPC-7525 for other stencil recommendations.

YPB0005

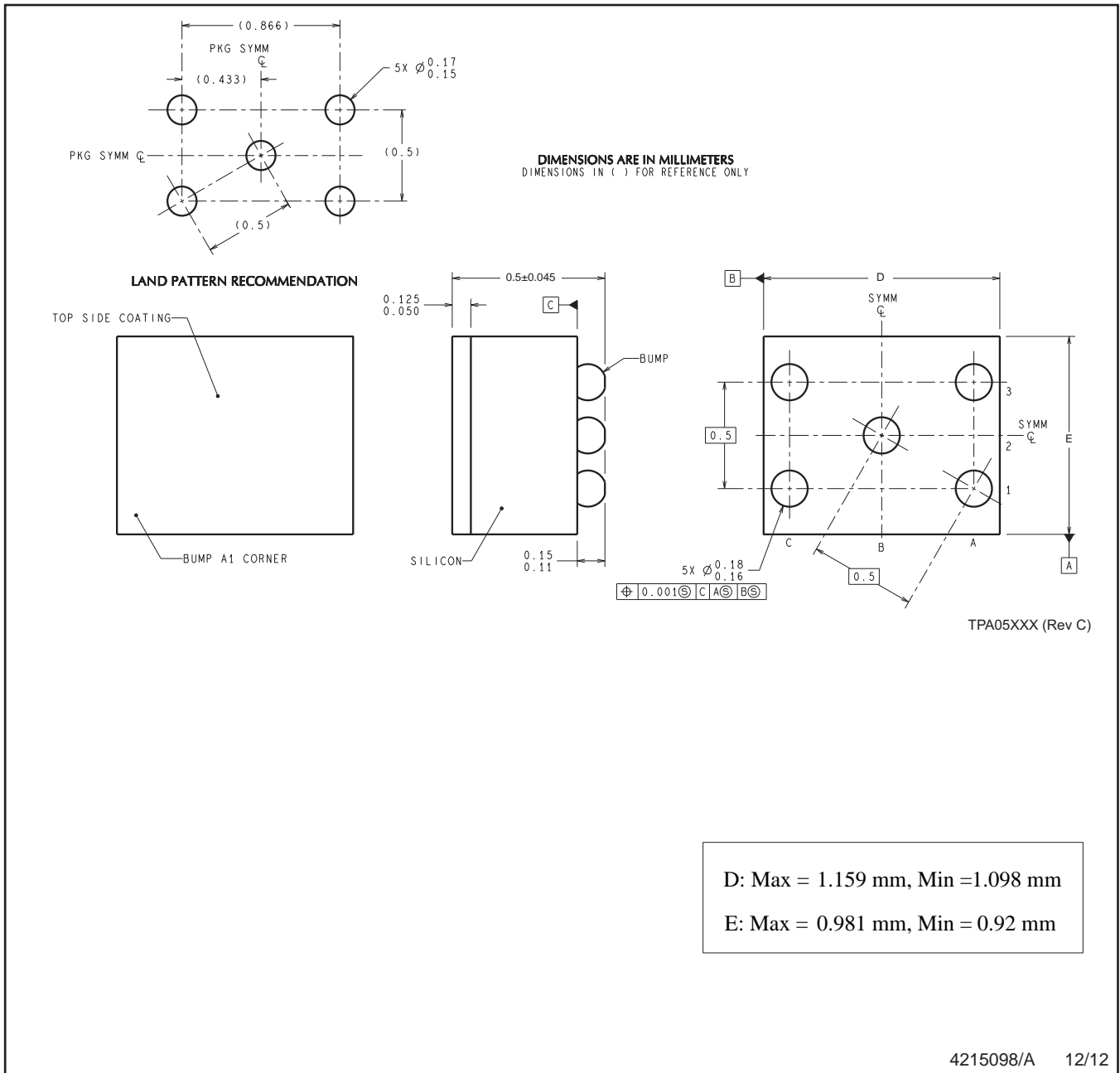

D: Max = 1.159 mm, Min = 1.098 mm  
 E: Max = 0.981 mm, Min = 0.92 mm

4215098/A 12/12

NOTES: A. All linear dimensions are in millimeters. Dimensioning and tolerancing per ASME Y14.5M-1994.  
 B. This drawing is subject to change without notice.

YZR0005

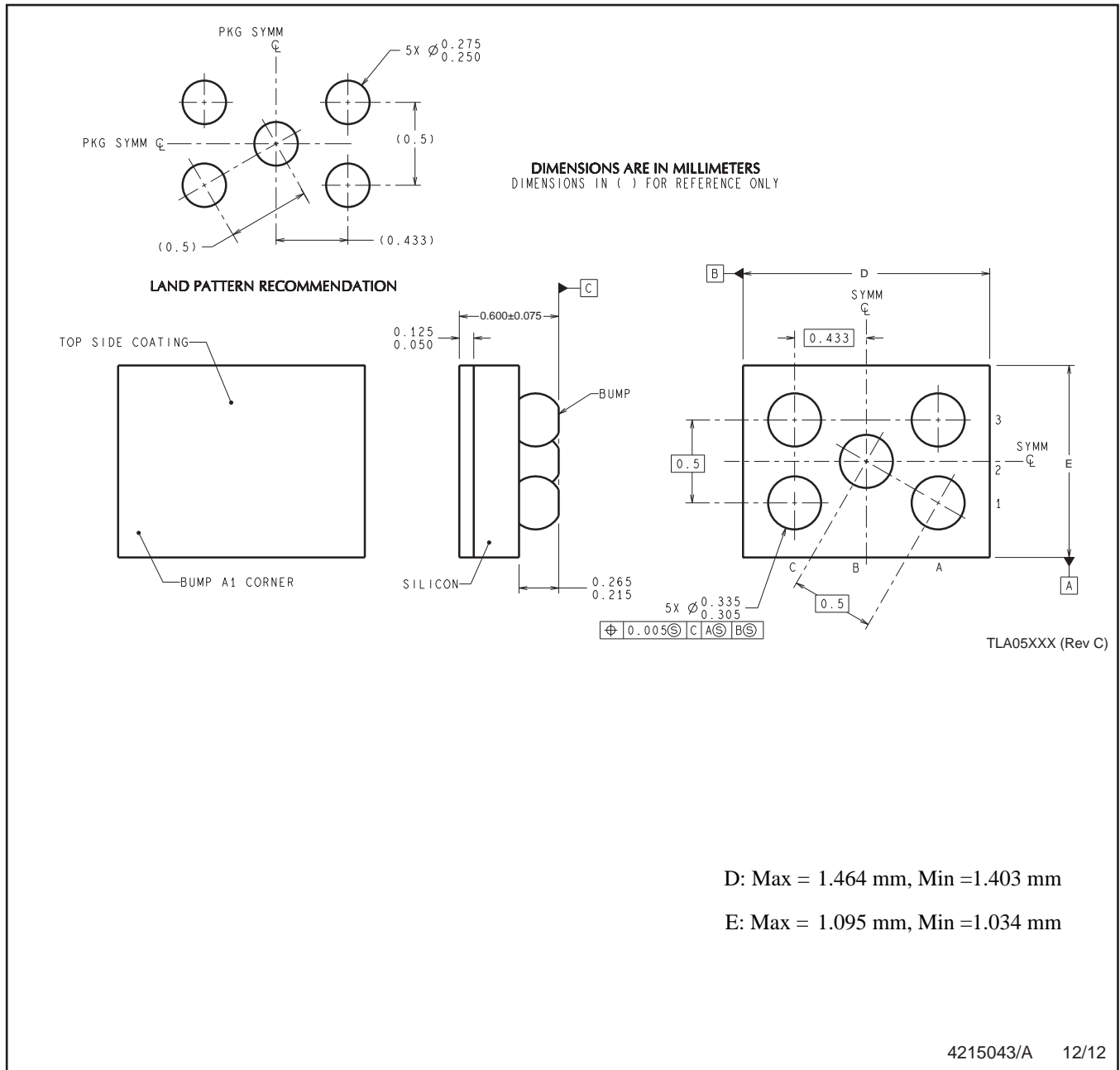

NOTES: A. All linear dimensions are in millimeters. Dimensioning and tolerancing per ASME Y14.5M-1994.  
 B. This drawing is subject to change without notice.



## IMPORTANT NOTICE

Texas Instruments Incorporated and its subsidiaries (TI) reserve the right to make corrections, enhancements, improvements and other changes to its semiconductor products and services per JESD46, latest issue, and to discontinue any product or service per JESD48, latest issue. Buyers should obtain the latest relevant information before placing orders and should verify that such information is current and complete. All semiconductor products (also referred to herein as "components") are sold subject to TI's terms and conditions of sale supplied at the time of order acknowledgment.

TI warrants performance of its components to the specifications applicable at the time of sale, in accordance with the warranty in TI's terms and conditions of sale of semiconductor products. Testing and other quality control techniques are used to the extent TI deems necessary to support this warranty. Except where mandated by applicable law, testing of all parameters of each component is not necessarily performed.

TI assumes no liability for applications assistance or the design of Buyers' products. Buyers are responsible for their products and applications using TI components. To minimize the risks associated with Buyers' products and applications, Buyers should provide adequate design and operating safeguards.

TI does not warrant or represent that any license, either express or implied, is granted under any patent right, copyright, mask work right, or other intellectual property right relating to any combination, machine, or process in which TI components or services are used. Information published by TI regarding third-party products or services does not constitute a license to use such products or services or a warranty or endorsement thereof. Use of such information may require a license from a third party under the patents or other intellectual property of the third party, or a license from TI under the patents or other intellectual property of TI.

Reproduction of significant portions of TI information in TI data books or data sheets is permissible only if reproduction is without alteration and is accompanied by all associated warranties, conditions, limitations, and notices. TI is not responsible or liable for such altered documentation. Information of third parties may be subject to additional restrictions.

Resale of TI components or services with statements different from or beyond the parameters stated by TI for that component or service voids all express and any implied warranties for the associated TI component or service and is an unfair and deceptive business practice. TI is not responsible or liable for any such statements.

Buyer acknowledges and agrees that it is solely responsible for compliance with all legal, regulatory and safety-related requirements concerning its products, and any use of TI components in its applications, notwithstanding any applications-related information or support that may be provided by TI. Buyer represents and agrees that it has all the necessary expertise to create and implement safeguards which anticipate dangerous consequences of failures, monitor failures and their consequences, lessen the likelihood of failures that might cause harm and take appropriate remedial actions. Buyer will fully indemnify TI and its representatives against any damages arising out of the use of any TI components in safety-critical applications.

In some cases, TI components may be promoted specifically to facilitate safety-related applications. With such components, TI's goal is to help enable customers to design and create their own end-product solutions that meet applicable functional safety standards and requirements. Nonetheless, such components are subject to these terms.

No TI components are authorized for use in FDA Class III (or similar life-critical medical equipment) unless authorized officers of the parties have executed a special agreement specifically governing such use.

Only those TI components which TI has specifically designated as military grade or "enhanced plastic" are designed and intended for use in military/aerospace applications or environments. Buyer acknowledges and agrees that any military or aerospace use of TI components which have **not** been so designated is solely at the Buyer's risk, and that Buyer is solely responsible for compliance with all legal and regulatory requirements in connection with such use.

TI has specifically designated certain components as meeting ISO/TS16949 requirements, mainly for automotive use. In any case of use of non-designated products, TI will not be responsible for any failure to meet ISO/TS16949.

### Products

|                              |  |
|------------------------------|--|
| Audio                        | <a href="http://www.ti.com/audio">www.ti.com/audio</a>                               |
| Amplifiers                   | <a href="http://amplifier.ti.com">amplifier.ti.com</a>                               |
| Data Converters              | <a href="http://dataconverter.ti.com">dataconverter.ti.com</a>                       |
| DLP® Products                | <a href="http://www.dlp.com">www.dlp.com</a>   |
| DSP                          | <a href="http://dsp.ti.com">dsp.ti.com</a>   |
| Clocks and Timers            | <a href="http://www.ti.com/clocks">www.ti.com/clocks</a>                             |
| Interface                    | <a href="http://interface.ti.com">interface.ti.com</a>                               |
| Logic                        | <a href="http://logic.ti.com">logic.ti.com</a>                                       |
| Power Mgmt                   | <a href="http://power.ti.com">power.ti.com</a>                                       |
| Microcontrollers             | <a href="http://microcontroller.ti.com">microcontroller.ti.com</a>                   |
| RFID                         | <a href="http://www.ti-rfid.com">www.ti-rfid.com</a>                                 |
| OMAP Applications Processors | <a href="http://www.ti.com/omap">www.ti.com/omap</a>                                 |
| Wireless Connectivity        | <a href="http://www.ti.com/wirelessconnectivity">www.ti.com/wirelessconnectivity</a> |

### Applications

|                               |  |
|-------------------------------|--|
| Automotive and Transportation | <a href="http://www.ti.com/automotive">www.ti.com/automotive</a>                         |
| Communications and Telecom    | <a href="http://www.ti.com/communications">www.ti.com/communications</a>                 |
| Computers and Peripherals     | <a href="http://www.ti.com/computers">www.ti.com/computers</a>                           |
| Consumer Electronics          | <a href="http://www.ti.com/consumer-apps">www.ti.com/consumer-apps</a>                   |
| Energy and Lighting           | <a href="http://www.ti.com/energy">www.ti.com/energy</a>                                 |
| Industrial                    | <a href="http://www.ti.com/industrial">www.ti.com/industrial</a>                         |
| Medical                       | <a href="http://www.ti.com/medical">www.ti.com/medical</a>                               |
| Security                      | <a href="http://www.ti.com/security">www.ti.com/security</a>                             |
| Space, Avionics and Defense   | <a href="http://www.ti.com/space-avionics-defense">www.ti.com/space-avionics-defense</a> |
| Video and Imaging             | <a href="http://www.ti.com/video">www.ti.com/video</a>                                   |

### TI E2E Community

[e2e.ti.com](http://e2e.ti.com)