

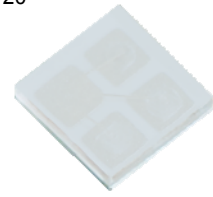

**ATTENTION**  
OBSERVE PRECAUTIONS  
FOR HANDLING  
ELECTROSTATIC  
DISCHARGE  
SENSITIVE  
DEVICES

Part Number: KPGF-1011GBRC-120

Green  
Blue  
Hyper-Red



### Features

- 1.0mmX1.0mm SMD LED, 0.2mm thickness.
- Low power consumption.
- Can produce any color in visible spectrum, including white light.
- Package : 4000pcs / reel.
- Moisture sensitivity level : level 3.
- Low current IF=5mA operating.
- RoHS compliant.

### Descriptions

- The Green source color devices are made with InGaN on SiC substrate Light Emitting Diode.
- The Blue source color devices are made with InGaN on SiC substrate Light Emitting Diode.
- The Hyper-Red source color devices are made with AlGaInP on GaAs substrate Light Emitting Diode.
- Electrostatic discharge and power surge could damage the LEDs.
- It is recommended to use a wrist band or anti-electrostatic glove when handling the LEDs.
- All devices, equipments and machineries must be electrically grounded.

### Package Dimensions

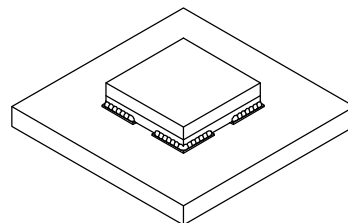
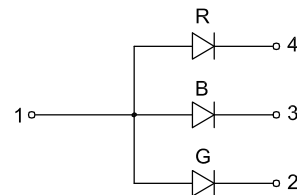
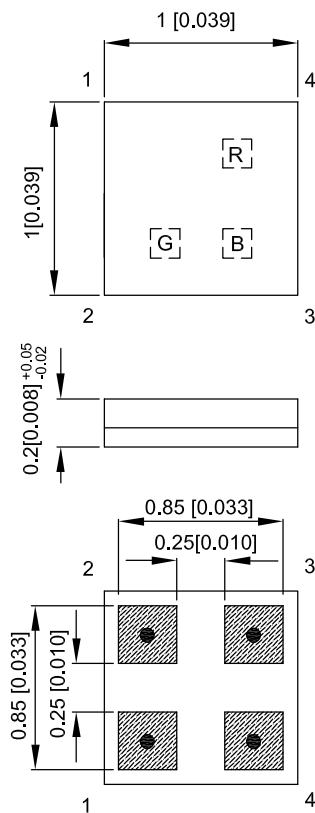

Notes:

1. All dimensions are in millimeters (inches).
2. Tolerance is  $\pm 0.1(0.004)$  unless otherwise noted.
3. The specifications, characteristics and technical data described in the datasheet are subject to change without prior notice.
4. The device has a single mounting surface. The device must be mounted according to the specifications.



## Selection Guide

Part No.	Emitting Color (Material)	Lens Type	Iv (mcd) [2] @ 5mA		Viewing Angle [1]		
			Min.	Typ.	2θ1/2		
					G	B	R
KPGF-1011GBRC-120	Green (InGaN)	Water Clear	50	80	150°	150°	130°
	Blue (InGaN)		10	23			
	Hyper-Red (AlGaInP)		15	30			

Notes:

1. θ1/2 is the angle from optical centerline where the luminous intensity is 1/2 of the optical peak value.
2. Luminous intensity / luminous Flux: +/-15%.
3. Luminous intensity value is traceable to the CIE127-2007 compliant national standards.

## Electrical / Optical Characteristics at TA=25°C

Symbol	Parameter	Emitting Color	Typ.	Max.	Units	Test Conditions
λ <sub>peak</sub>	Peak Wavelength	Green Blue Hyper-Red	518 461 632		nm	I <sub>F</sub> =5mA
λ <sub>D</sub> [1]	Dominant Wavelength	Green Blue Hyper-Red	527 467 624		nm	I <sub>F</sub> =5mA
Δλ <sub>1/2</sub>	Spectral Line Half-width	Green Blue Hyper-Red	35 22 20		nm	I <sub>F</sub> =5mA
C	Capacitance	Green Blue Hyper-Red	100 110 25		pF	V <sub>F</sub> =0V;f=1MHz
V <sub>F</sub> [2]	Forward Voltage	Green Blue Hyper-Red	3 2.9 1.95	3.2 3.1 2.3	V	I <sub>F</sub> =5mA
I <sub>R</sub>	Reverse Current	Green Blue Hyper-Red		50 50 10	μA	V <sub>R</sub> =5V

Notes:

1. Wavelength: +/-1nm.
2. Forward Voltage: +/-0.1V.
3. Wavelength value is traceable to the CIE127-2007 compliant national standards.
4. Excess driving current and/or operating temperature higher than recommended conditions may result in severe light degradation or premature failure.

## Absolute Maximum Ratings at TA=25°C

Parameter	Green	Blue	Hyper-Red	Units
Power dissipation [1]	35			mW
DC Forward Current [2]	10	10	10	mA
Peak Forward Current [3]	50	50	50	mA
Electrostatic Discharge Threshold (HBM)	1000	1000	3000	V
Reverse Voltage	5			V
Operating Temperature	-40°C To +85°C			
Storage Temperature	-40°C To +100°C			

Notes:

1. Within 35mW when multiple chips are lightened
2. The maximum ratings are valid for the case of lighting a single chip  
When two chips are lit at the same time, each chip should be driven at a current lower than 50% of the absolute maximum ratings  
When three chips are lit at the same time, each chip should be driven at a current lower than 30% of the absolute maximum ratings
3. Duty Cycle 1/20, Pulse Width=1ms.

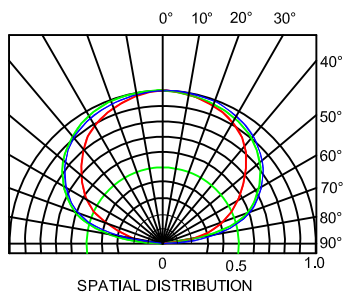
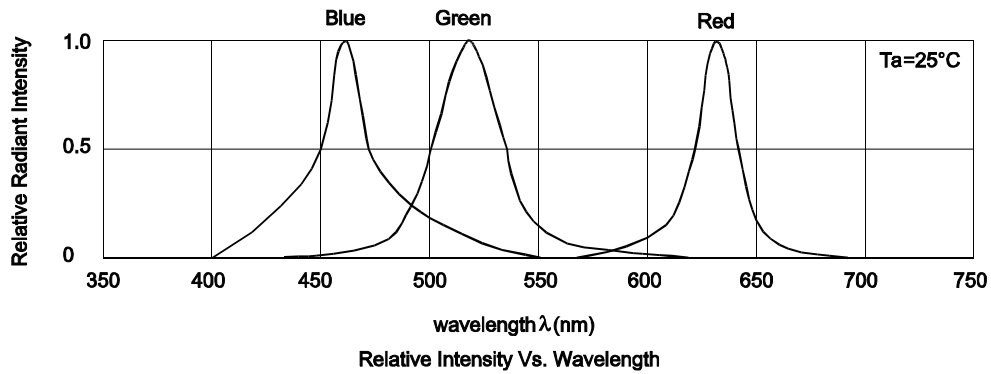

**KPGF-1011GBRC-120**  
**Green**

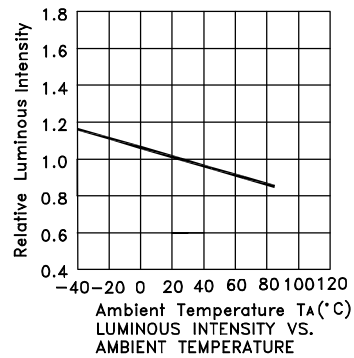
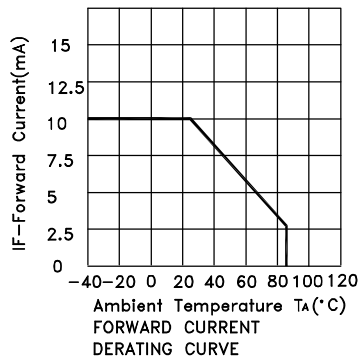
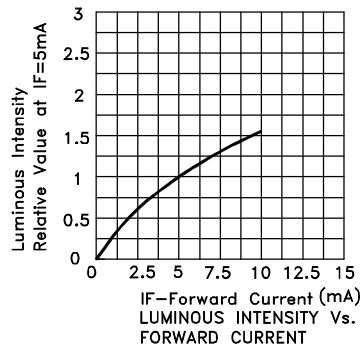
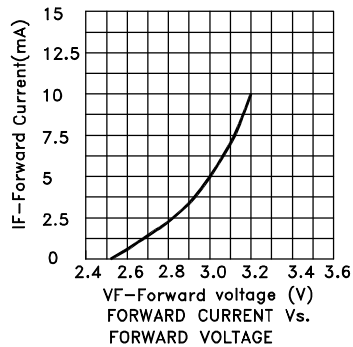

## Blue

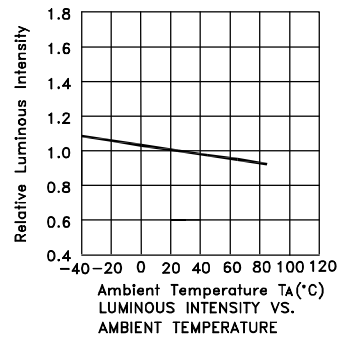
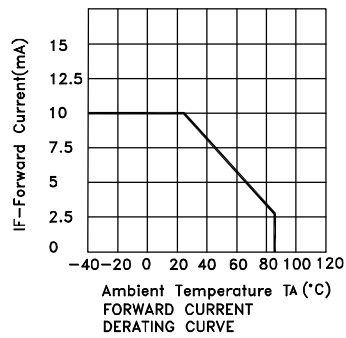
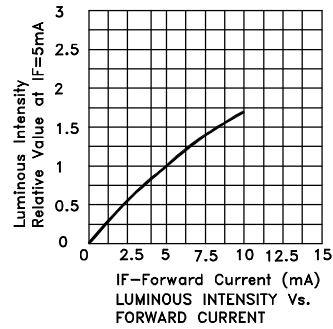
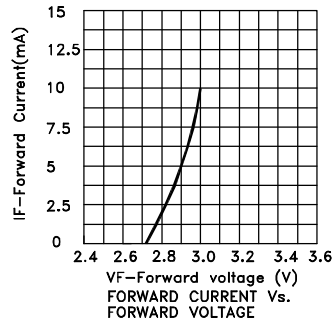

## Hyper-Red

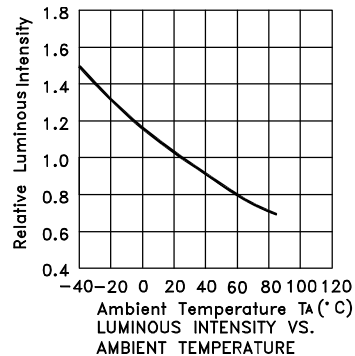
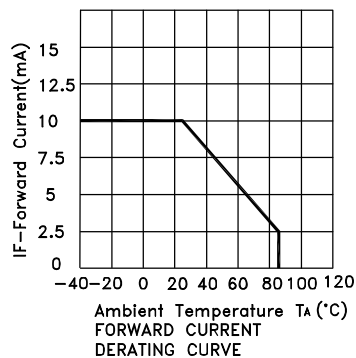
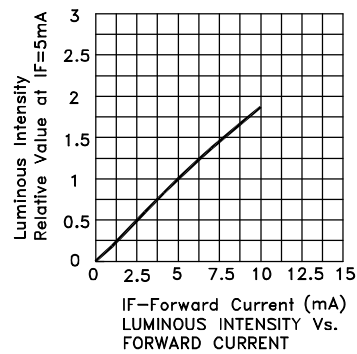
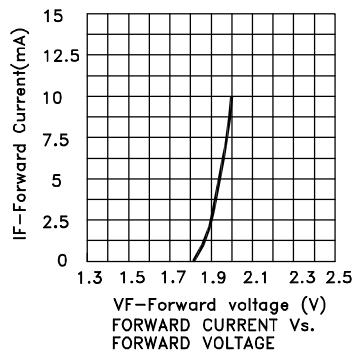

## KPGF-1011GBRC-120

Reflow soldering is recommended and the soldering profile is shown below.  
Other soldering methods are not recommended as they might cause damage to the product.

Reflow Soldering Profile For Lead-free SMT Process.

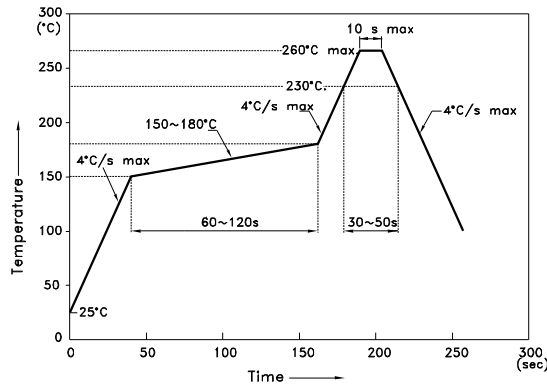

**NOTES:**

1. We recommend the reflow temperature 245°C(+/-5°C), The maximum soldering temperature should be limited to 260°C.
2. Don't cause stress to the epoxy resin while it is exposed to high temperature.
3. Number of reflow process shall be 2 times or less.

**Recommended Soldering Pattern**  
(Units : mm; Tolerance: ± 0.1)

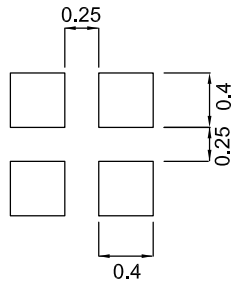

**Reel Dimension**

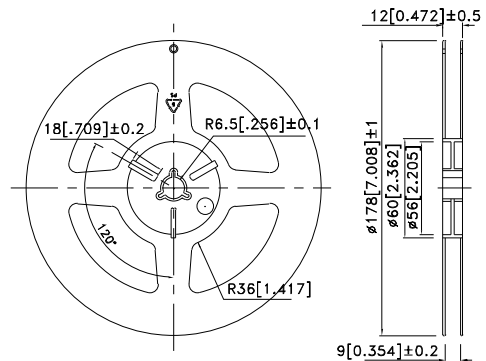

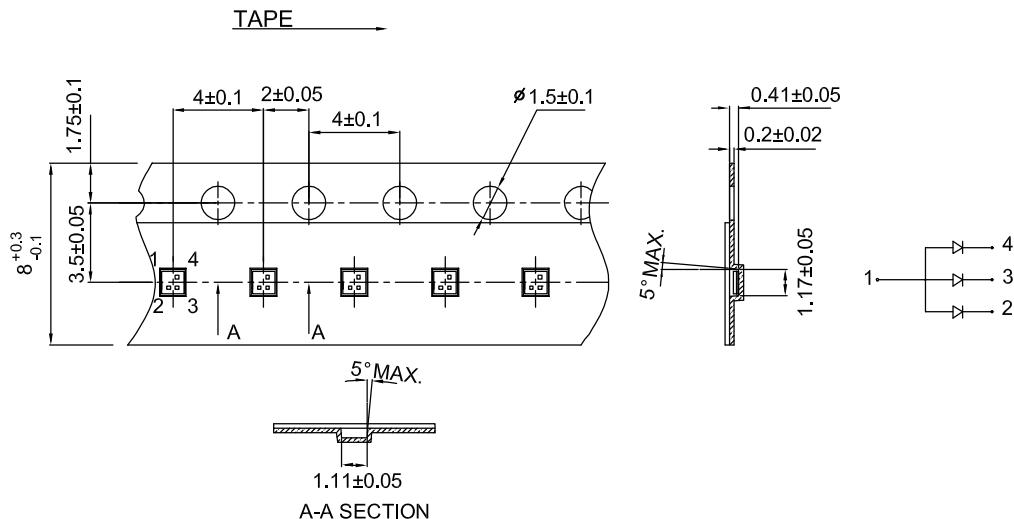

**Tape Dimensions**  
(Units : mm)

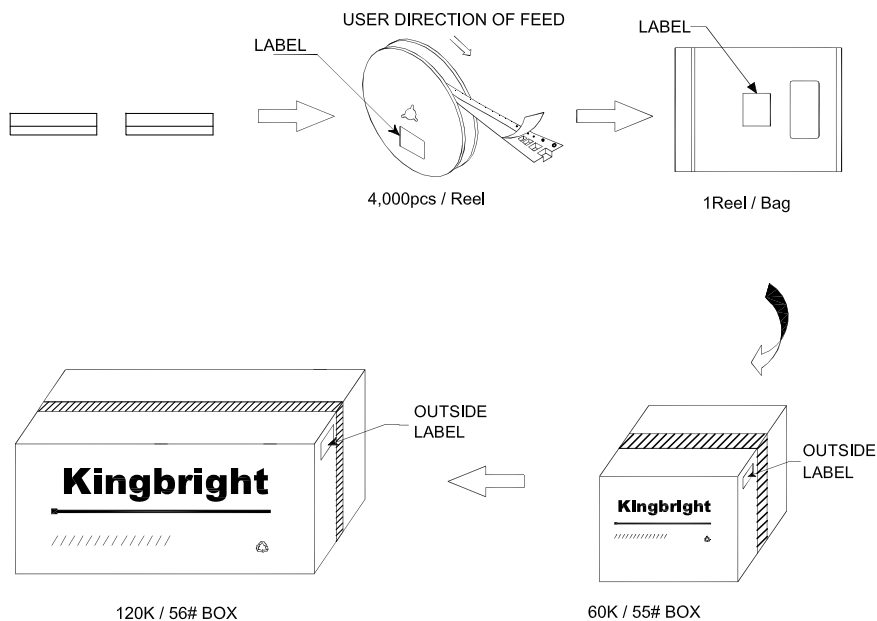

## PACKING & LABEL SPECIFICATIONS

## KPGF-1011GBRC-120



<b>Kingbright</b>		
P/NO: <b>KPGF-1011xxx</b>		
QTY: 4,000 pcs	Q.C.	Q C xxxxxxx PASSED
S/N: XXXX		
CODE: XXX		
LOT NO:		
		
RoHS Compliant		

### Terms and conditions for the usage of this document

1. The information included in this document reflects representative usage scenarios and is intended for technical reference only.
2. The part number, type, and specifications mentioned in this document are subject to future change and improvement without notice. Before production usage customer should refer to the latest datasheet for the updated specifications.
3. When using the products referenced in this document, please make sure the product is being operated within the environmental and electrical limits specified in the datasheet. If customer usage exceeds the specified limits, Kingbright will not be responsible for any subsequent issues.
4. The information in this document applies to typical usage in consumer electronics applications. If customer's application has special reliability requirements or have life-threatening liabilities, such as automotive or medical usage, please consult with Kingbright representative for further assistance.
5. The contents and information of this document may not be reproduced or re-transmitted without permission by Kingbright.
6. All design applications should refer to Kingbright application notes available at [http://www.kingbright.com/application\\_notes](http://www.kingbright.com/application_notes)