

TOP VIEW OF BOX

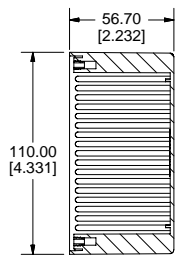

SECTION B-B

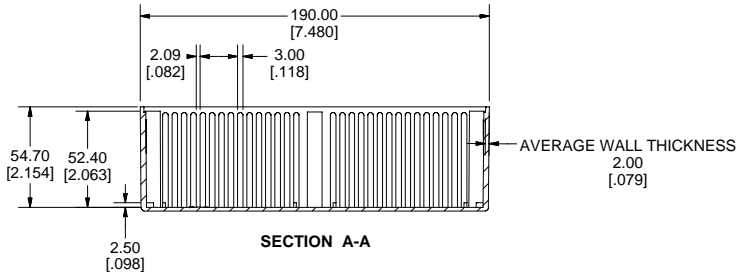

SECTION A-A

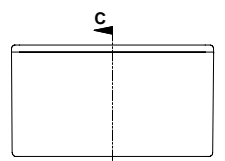

END VIEW OF ASSEMBLY

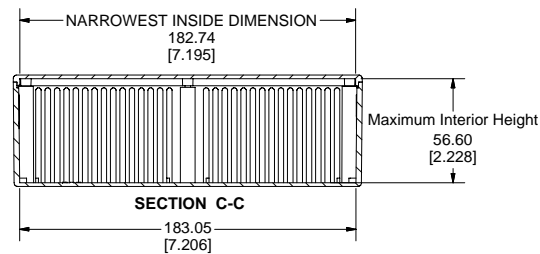

SECTION C-C

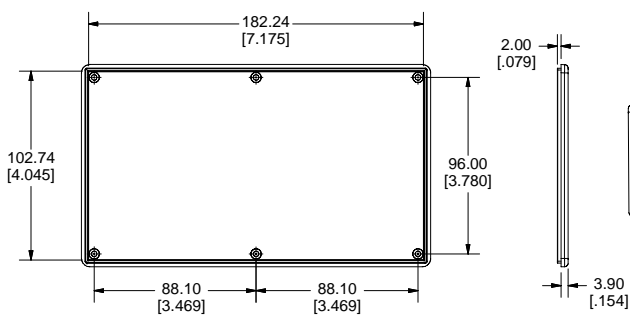

BOTTOM OF LID

SIDE OF LID

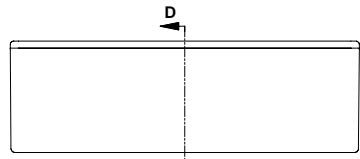

SIDE VIEW OF ASSEMBLY

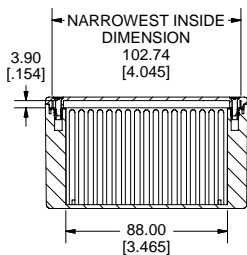

SECTION D-D

Note:
 Enclosures can be Factory Modified (Milling, Drilling, Printing etc.)
 Contact Factory mjm@hammondmfg.com for quotes
 Solid models of this enclosure available in STEP or IGES Format.

PART NUMBERS		
1591E Enclosures		
Material	Colour	Part Number
FR ABS UL94 - V0	Beige	1591EBG
	Black	1591EBK
	Blue	1591EBU
	Grey	1591EGY
GP ABS UL94 - HB	Black	1591ESBK
	Grey	1591ESGY
Translucent Polycarbonate	Ice Blue	1591ETBU
	IR Red	1591ETRD
	Crystal Clear	1591ETCL
Accessories		
	Description	Part Number
Universal Use	PC Board Card Adapters	See Accessories Section
	Clear Lids - clear, flame retardant polycarbonate - Lid ONLY	1591EC
FR ABS	Replacement Screws, Flat Head Phillips	1591MS100
	Nickel Plated Pkg of 100	1591MS100BK (Black) 1591TS100
GP ABS	Self Tapping Pkg of 100	1591TS100BK (Black)
Recommended Torque on Fasteners (no lubrication)		
	M3 - 0.5 x 10mm Screws	30-40 cN*m
	#4 x 0.5 Screws	30-40 cN*m

HAMMOND MANUFACTURING™
 1591E
www.hammondmfg.com