



DC COMPONENTS CO., LTD.

RECTIFIER SPECIALISTS

**GBK15A
THRU
GBK15M**

TECHNICAL SPECIFICATIONS OF SINGLE-PHASE GLASS PASSIVATED BRIDGE RECTIFIER

VOLTAGE RANGE - 50 to 1000 Volts

CURRENT - 15 Amperes

FEATURES

- * Ideal for printed circuit board
- * Surge overload rating: 240 Amperes peak
- * Glass passivated junction

MECHANICAL DATA

- * Case: Molded plastic
- * Epoxy: UL 94V-0 rate flame retardant
- * Terminals: MIL-STD-202E, Method 208 guaranteed
- * Polarity: Symbols molded or marked on body
- * Mounting position: Any

MAXIMUM RATINGS AND ELECTRICAL CHARACTERISTICS

Ratings at 25°C ambient temperature unless otherwise specified.
Single phase, half wave, 60Hz, resistive or inductive load.
For capacitive load, derate current by 20%.

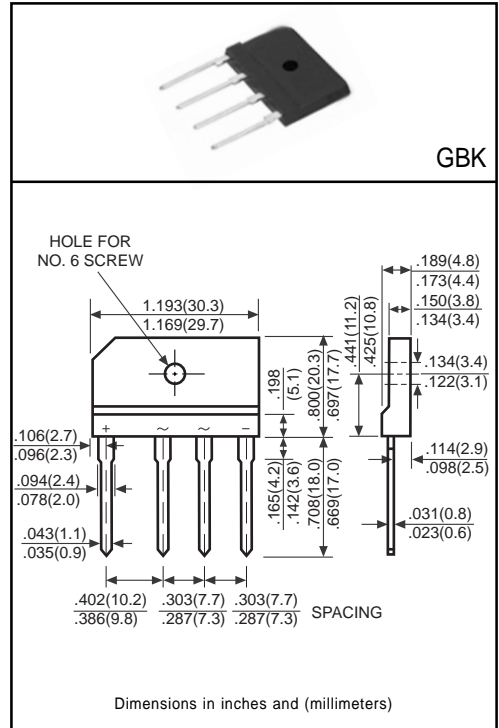

	SYMBOL	GBK15A	GBK15B	GBK15D	GBK15G	GBK15J	GBK15K	GBK15M	UNITS
Maximum Recurrent Peak Reverse Voltage	V _{RRM}	50	100	200	400	600	800	1000	Volts
Maximum RMS Bridge Input Voltage	V _{RMS}	35	70	140	280	420	560	700	Volts
Maximum DC Blocking Voltage	V _{DC}	50	100	200	400	600	800	1000	Volts
Maximum Average Forward Rectified Current @ T _c =50°C	I _(AV)	15 3.2							Amps
Peak Forward Surge Current 8.3 ms single half sine-wave superimposed on rated load (JEDEC Method)	I _{FSM}	240							Amps
Maximum Forward Voltage Drop per element at 7.5A DC	V _F	1.1							Volts
Maximum DC Reverse Current at Rated DC Blocking Voltage per element	@ T _J = 25°C	10							μAmps
	@ T _J = 125°C	500							
I ² t Rating for Fusing (t<8.3ms)	I ² t	240							A ² Sec
Typical Junction Capacitance (Note1)	C _J	60							pF
Typical Thermal Resistance (Note 2)	R _{θJA}	0.8							°C/W
Operating Temperature Range	T _J	-55 to +150							°C
Storage Temperature Range	T _{STG}	-55 to +150							°C

NOTES : 1.Measured at 1 MHz and applied reverse voltage of 4.0 volts

2.Thermal Resistance from Junction to Case per element Unit mounted on 100x100x1.6mm Cu plate heat-sink.

RATING AND CHARACTERISTIC CURVES (GBK15A THRU GBK15M)

FIG. 1 - MAXIMUM NON-REPETITIVE FORWARD SURGE CURRENT

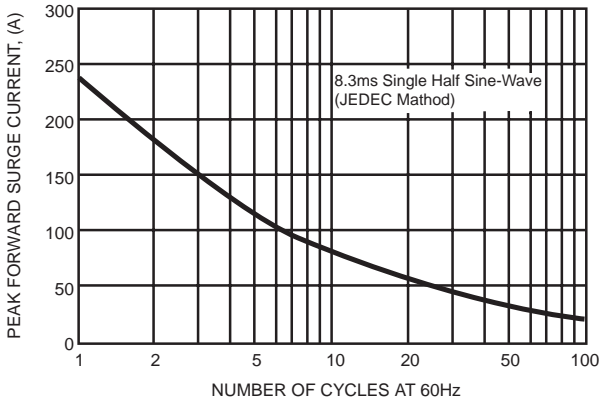

FIG. 2 - TYPICAL FORWARD CURRENT DERATING CURVE

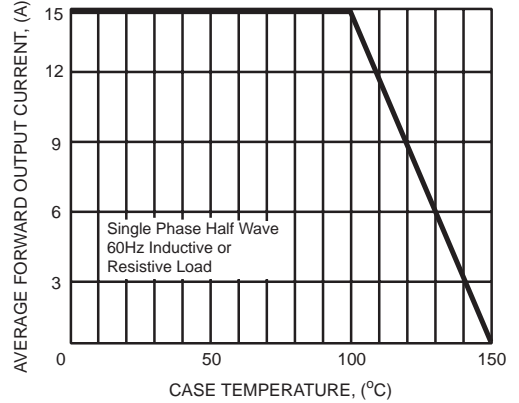

FIG. 3 - TYPICAL INSTANTANEOUS FORWARD CHARACTERISTICS

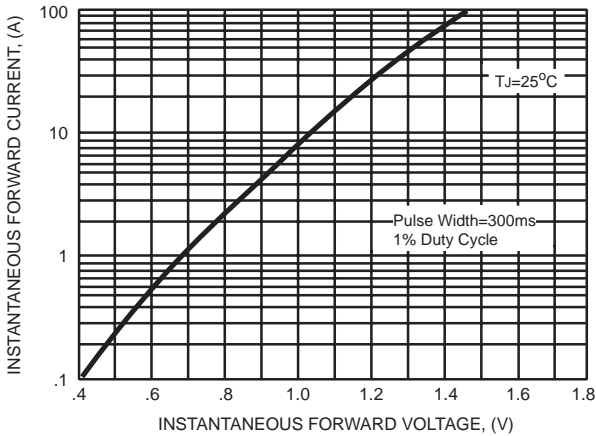
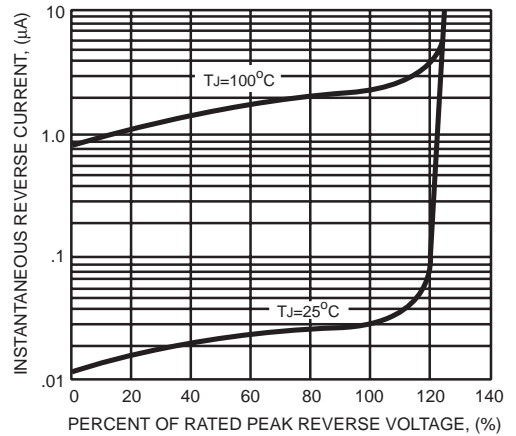

FIG. 4 - TYPICAL REVERSE CHARACTERISTICS



DC COMPONENTS CO., LTD.