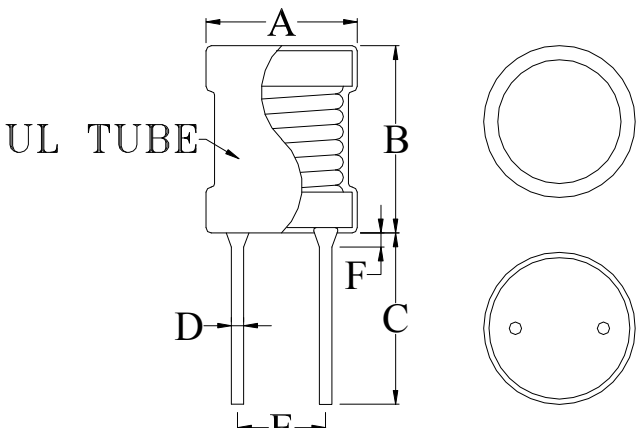

COMMODITY	PK CHOKE	SPEC NO.	SP-060824076
ITEM	COIL0608-0.01 Green		

(1) DIMENSION: (UNIT: mm)		DIM.	TOL.
	A	7.5	MAX.
	B	9.5	MAX.
	C	16	MIN.
	D	0.65	±0.05
	E	3.0	±0.5
	F	3.0	MAX.
	G		
	H		
	I		
	J		

(2) ELECTRICAL CHARACTERISTIC			TEST INSTRUMENTS.
INDUCTANCE	10 ± 10%	μH	<input checked="" type="checkbox"/> AGILENT 4294A Precision Impedance Analyzer. <input type="checkbox"/> AGILENT 4285A Precision L.C.R. Meter. <input type="checkbox"/> HP-4286A RF L.C.R. Meter.
TEST FREQUENCY	1	KHz	<input type="checkbox"/> ZENTECH 3302 Automatic Components Analyzer. <input type="checkbox"/> ZENTECH 101 L.C.R. Meter.
TEST VOLT	0.25	V	<input checked="" type="checkbox"/> WAYNE KERR 6420 Precision Impedance Analyzer. <input type="checkbox"/> ZENTECH 502AC Resistance Merter.
RDC	40.38 (max)	mΩ	<input checked="" type="checkbox"/> ZENTECH 1320 BIAS CURRENT. <input type="checkbox"/> ADEX AX-1155B DC Low Ohm Meter.
Isat *1	3.0 (max)	A	
Irms *2	4.0 (max)	A	

REMARK :
 1. Inductance drop = 10% typ at IDC.