

1. Scope of Application

These specifications apply to chip type LED lamp, CITELED, model CL-482S-TD2-CD-TS.

2. Part code

Reference

CL-482S-TD2-C D-TS

Series _____

482S: Mono-color
Ultra small, thin, sideways
light emission type

Lighting color _____

TD2 : Top high brightness orange

Color of lens _____

C : colored

Diffusion _____

D : Diffused

Shipping mode _____

Non-coded: Bulk
TS: Taping (standard)

			Approved	Checked	Drawn	Symbol	CITELED
						Name	CL-482S-TD2
						Drawing No	
Mark	Date	Description				Appro.	CITIZEN ELECTRONICS CO.,LTD.

3. Outline drawing

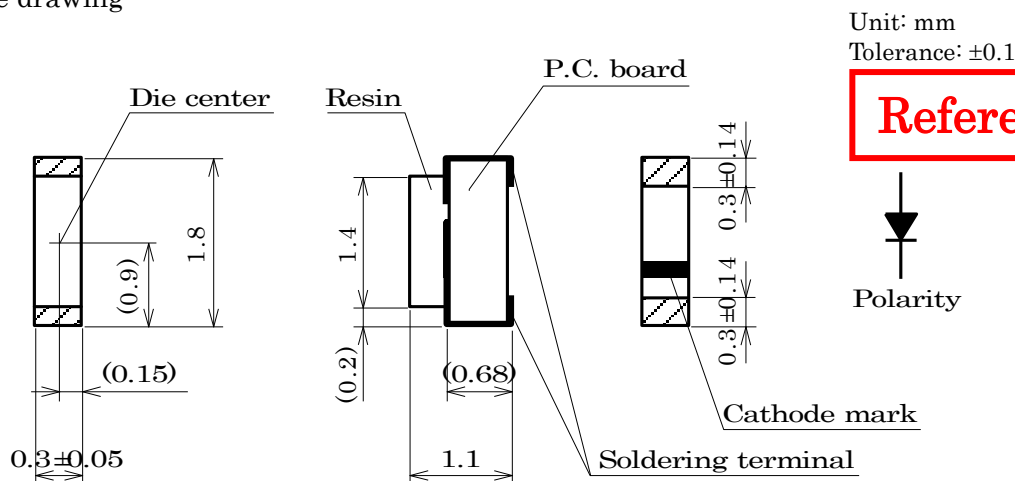

4. Performance

(1) Absolute Maximum Rating (Ta=25°C)

Parameter	Symbol	Rating Value	Unit
Power Dissipation	Pd	78	mW
Forward Current	IF	30	mA
Forward Pulse Current *	IFP	100 *	mA
Reverse Voltage	VR	4	V
Operating Temperature	Top	-25 ~ +80	°C
Storage Temperature	Tst	-30 ~ +85	°C

* Duty ≤ 1/10, Pulse width ≤ 0.1 msec

(2) Electro-optical Characteristic (Ta=25°C)

Parameter	Symbol	Condition	MIN	TYP	MAX	Unit
Forward Voltage	VF	IF=20mA	—	2.1	2.68	V
Reverse Current	IR	VR=4V	—	—	100	μA
Luminous Intensity *	IV	IF=20mA	23	110	—	mcd
Dominant Wavelength	λd	IF=20mA	595	605	615	nm

* In accordance with NIST standard

- Note 1) The tolerance of Forward Voltage measurement is ±3% at our tester.
- Note 2) The tolerance of Luminous Intensity measurement is ±10% at our tester.
- Note 3) The tolerance of Dominant Wavelength measurement is ±2nm at our tester.
- Note 4) For handling, please apply CMOS LSI or equivalent to prevent any electrostatic effect.
- Note 5) Please be aware that the above electro-optical characteristics are guaranteed when applying the current values shown in the table.
Please consult us when this product is used under any other conditions.

			Approved	Checked	Drawn	Symbol	CITELED
						Name	CL-482S-TD2
						Drawing No	
Mark	Date	Description	Appro.	CITIZEN ELECTRONICS CO.,LTD.			

Reference

5. Characteristic

IF-VF Characteristics

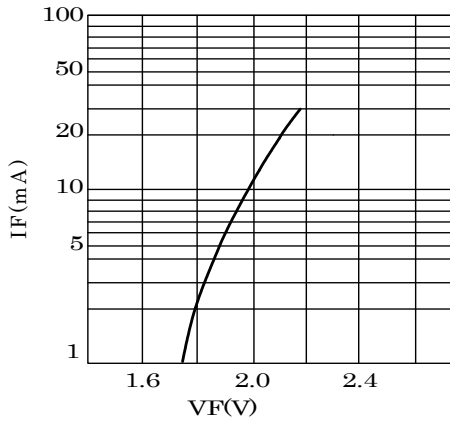

VF-Ta Characteristics

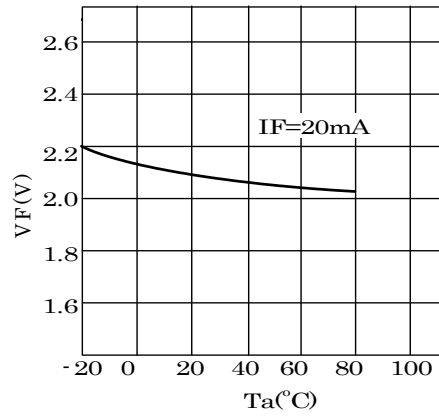

IV-IF Characteristics

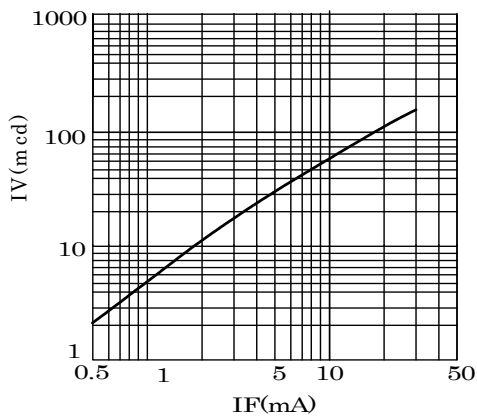

IV-Ta Characteristics

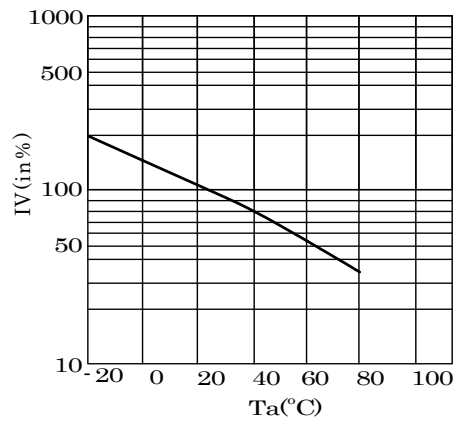

IF Max-Ta Characteristics

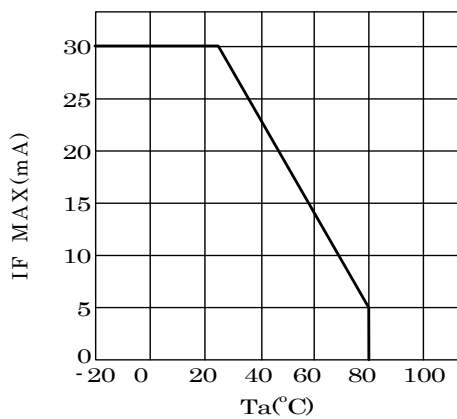

Directive Characteristics

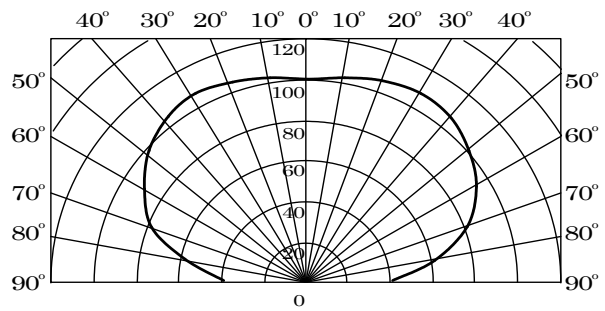

				Approved	Checked	Drawn	Symbol	CITELED
							Name	CL-482S-TD2
							Drawing No	
Mark	Date	Description	Appro.	CITIZEN ELECTRONICS CO.,LTD.				

6. Reliability

Reference

(1) Details of the tests

Test Item	Test Condition
Life Test in Continuous Operation	$25 \pm 3^{\circ}\text{C}$, $I_F = 30 \text{ mA} \times 500^{+24}_{-12}$ hours
Low Temperature Storage Test	$-30^{+3}_{-3} \text{ }^{\circ}\text{C} \times 500^{+24}_{-12}$ hours
High Temperature Storage Test	$85^{+5}_{-3} \text{ }^{\circ}\text{C} \times 500^{+24}_{-12}$ hours
Moisture-proof Test	$60 \pm 2^{\circ}\text{C}$, $90 \pm 5\% \text{RH}$ for 500^{+24}_{-12} hours
Thermal Shock Test	$-30^{\circ}\text{C} \times 30 \text{ minutes} - 85^{\circ}\text{C} \times 30 \text{ minutes}$, 5-cycle
Solder Heat Resistance Test	Recommended temperature profile (reflow soldering) $\times 2$, (2 nd test must be started after the samples are stabilized thermally.)

(2) Judgment Criteria of Failure for Reliability Test

Measuring Item	Symbol	Measuring Condition	Judgement Criteria for Failure
Forward Voltage	V_F	$I_F = 20 \text{ mA}$	$>U \times 1.2$
Reverse Current	I_R	$V_R = 4 \text{ V}$	$>U \times 2$
Luminous Intensity	I_V	$I_F = 20 \text{ mA}$	$<S \times 0.5$

U means the upper limit of the specified characteristics. S means the initial value.

Note: Measurement shall be taken between 2 hours and 24 hours, having returned the test pieces to the normal ambient conditions after the completion of each test.

			Approved	Checked	Drawn	Symbol	CITELED
						Name	CL-482
						Drawing No	
Mark	Date	Description	Appro.	CITIZEN ELECTRONICS CO.,LTD.			

Reference

7. Taping Specifications (in accordance with JIS standard)

(1) Shape and Dimensions of Reel

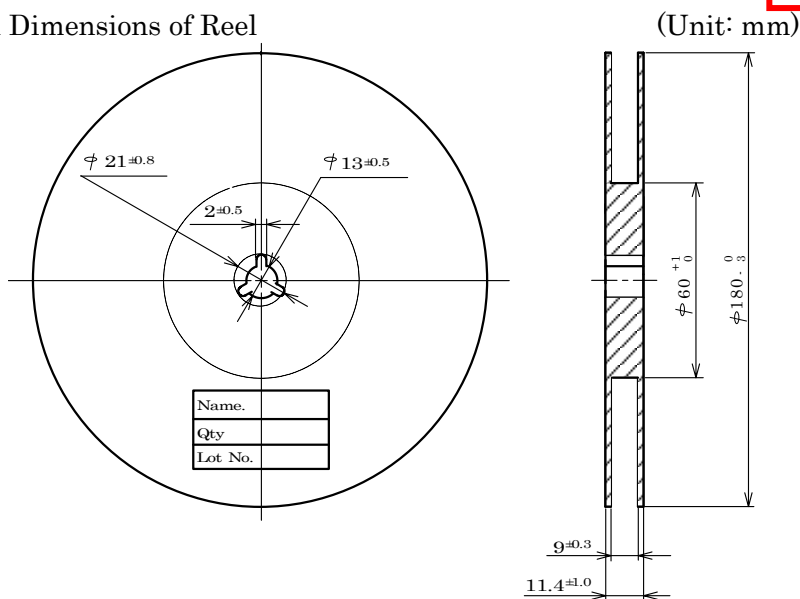

Name.
Qty
Lot No.

(2) Dimensions of Tape

(Unit: mm)

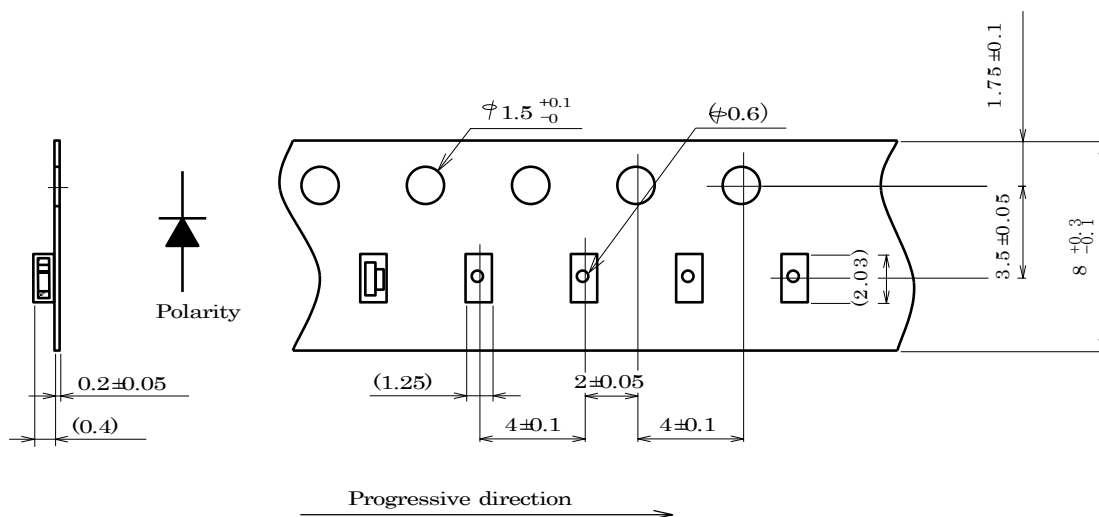

(3) Configuration of Tape

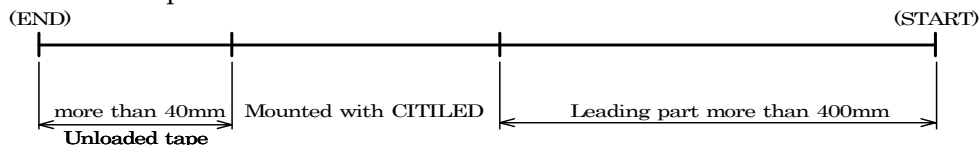

(4) Quantity: 5,000pcs/reel

(Please note that the shipping quantity of this product may be less than 5000 pieces per reel (minimum quantity: 1000 pieces) depending on the shipping quantity, shipping delivery date and other conditions. However, in this case, we will announce to you in advance.)

			Approved	Checked	Drawn	Symbol	CITED
						Name	CL-482S
						Drawing No	
Mark	Date	Description	Appr.	CITIZEN ELECTRONICS CO.,LTD.			

Reference

8. Packing Specifications

8-1. Moisture-proof Packing

To prevent moisture absorption during transportation and storage, reels are packed in aluminum envelopes which contain a desiccant with a humidity indicator.

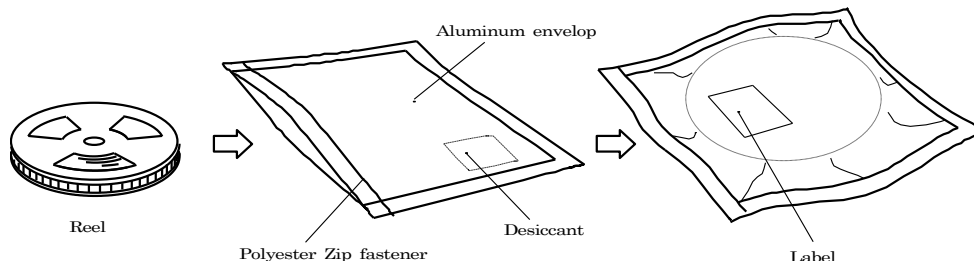

8-2. Storage

To prevent moisture absorption, it is strongly recommended that reels (in bulk or taped) should be stored in the dry box (or the desiccator) with a desiccant as the appropriate storage place. If not, the following is recommended.

Temperature: 5 ~ 30 °C
 Humidity: 60%RH max.

The devices should be mounted as soon as possible after unpacking. If you store the unpacked reels, please store them in the dry box or seal them into the envelop again.

8-3. Baking

If the devices have been stored over 6 months or unpacked over 7 days, it should be baked under the following conditions.

Baking conditions: 60°C × 12 hours or more (reeled one)
 100°C × 45 minutes or more (loose one)

			Approved	Checked	Drawn	Symbol	CITELED
						Name	CL-482
						Drawing No	
Mark	Date	Description	Appro.	CITIZEN ELECTRONICS CO.,LTD.			

9. Precautions

Reference

9-1. Soldering

(1) Manual soldering

- 1) Solder of 96.5Sn 3Ag 0.5Cu is recommended.
- 2) Before soldering every time, make baking to units. By manual soldering, it is the possibility of crack due to the moisture absorption in the resin portion.
- 3) Use a soldering iron of 25W or smaller. Adjust the temperature of the soldering iron below 350°C.
- 4) Force or stress must not be applied to the resin portion while soldering.
- 5) Finish soldering within 3 seconds.
- 6) Handle the devices only after temperature is cooled down.

(2) Lead free soldering

- 1) Following soldering paste is recommended
 Melting temperature: 216 ~ 220°C.
 Composition: 96.5Sn 3Ag 0.5Cu
- 2) The temperature profile at the top surface of the parts is recommended as shown below.
- 3) It is requested that products should be handled after their temperature has dropped down to the normal room temperature.

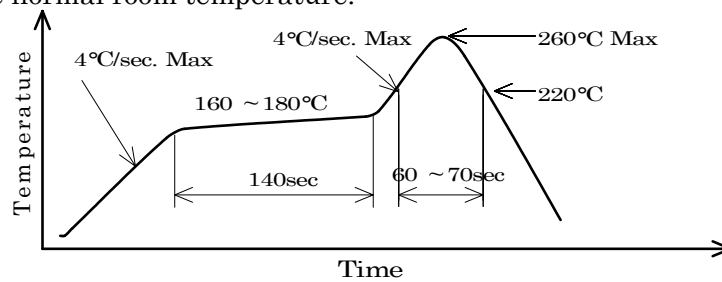

			Approved	Checked	Drawn	Symbol	CITILED
						Name	CL-482
						Drawing No	
Mark	Date	Description	Appro.	CITIZEN ELECTRONICS CO.,LTD.			

Reference

9-2. Washing

- (1) When washing after soldering is needed, following conditions are requested.
 - a) Washing solvent: Alcohol
 - b) Temperature, time: 50°C or less × 30 seconds max.
or 30°C or less × 3 minutes max.
 - c) Ultrasonic washing: 300W or less

9-3. Other directions

- (1) It is requested to avoid any stress added to the resin portion while it is heated.
- (2) It is requested to avoid any friction by sharp metal nail etc. to the resin portion.

10. Designing precautions

- (1) The current limiting resistor should be placed in the circuit so that is driven within its rating. Also avoid reverse voltage (over-current) applied instantaneously when ON or OFF.
- (2) When pulse driving current is applied, average current consumption should be within the rating. Also avoid reverse voltage applied when put off.
- (3) Recommended soldering pattern

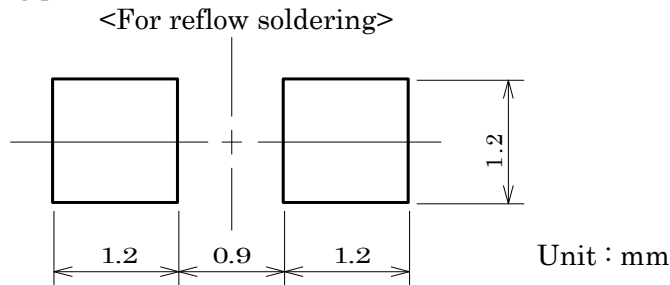

The above dimensions are not the one which guarantee the performance of mountability.

The use of the above pattern is recommended to use after deep study at your site.

- (4) When assembling the circuit board into the finished products, care must be taken to avoid the component parts from touching other parts.
- (5) When using multiple LEDs, it is required to connect a current limiting resistor on each path which the current flows to the LEDs.

(ex-1)

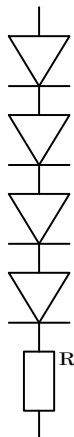

(ex-2)

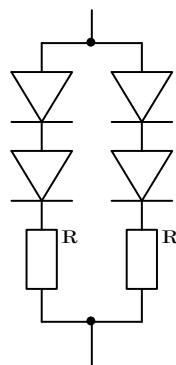

(ex-3)

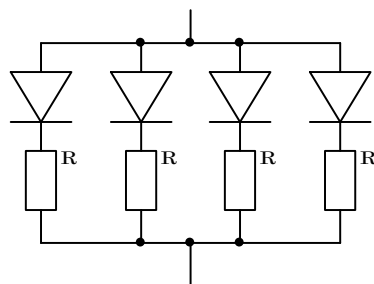

				Approved	Checked	Drawn	Symbol	CITELED
							Name	CL-482
							Drawing No	
Mark	Date	Description	Appro.	CITIZEN ELECTRONICS CO.,LTD.				