

## DETAILS

<b>Product Number</b>	CA10927_STRADA-B
<b>Family</b>	Strada-B
<b>Type</b>	Assembly
<b>Color</b>	clear
<b>Diameter</b>	19,6 + 15,5 mm
<b>Height</b>	5.2 mm
<b>Style</b>	rectang
<b>Optic Material</b>	PMMA
<b>Holder Material</b>	
<b>Fastening</b>	screw, tape
<b>Status</b>	ready
<b>ROHS Compliant</b>	Yes
<b>Date Updated</b>	10/06/2014



## OPTICAL PROPERTIES

LED	Viewing Angle	Light Beam	Efficiency	cd/lm	Connector
Z5	sim: 110+40	Streetligh...	93 %	-	-
XP-G	112+42 deg	Streetligh...	93 %	0.500	-
H35C0 (LEMWA33)	112+43 deg	Streetligh...	88 %	0.500	-
XP-E	116+44 deg	Streetligh...	93 %	0.560	-

D

C

B

A

4

4

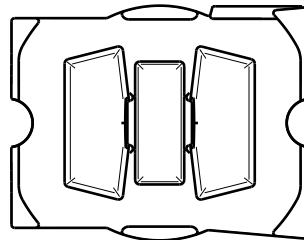

5.2

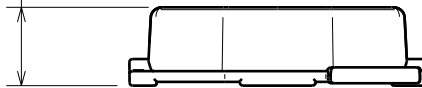

3

3

19.6

∅ 3.2

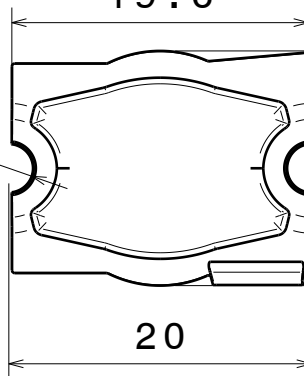

Top view

15.5

20

fastening

2

2

MATERIALS  
Lens: PMMA

This drawing is our property.  
It can't be reproduced  
or communicated without  
our written agreement.



L  
T  
F  
F

e  
e  
i  
i  
N  
n

d  
h

DRAWING TITLE

Datasheet Strada-B-XP lens

1

1

DRAWN BY

DATE

p

03.06.2009

CHECKED BY

DATE

t

k

21.04.2009

DESIGNED BY

DATE

hh

20.04.2009

SIZE

DRAWING NUMBER

REV

A4

C10926

1

SCALE

2:1

WEIGHT (g)

SHEET

1/1

D

A

# Ledil Oy C10926\_Strada-B-XPG C10926\_Strada-B-XPG / LDC (Linear)

Luminaire: Ledil Oy C10926\_Strada-B-XPG C10926\_Strada-B-XPG  
Lamps: 1 x Cree XP-G (White)

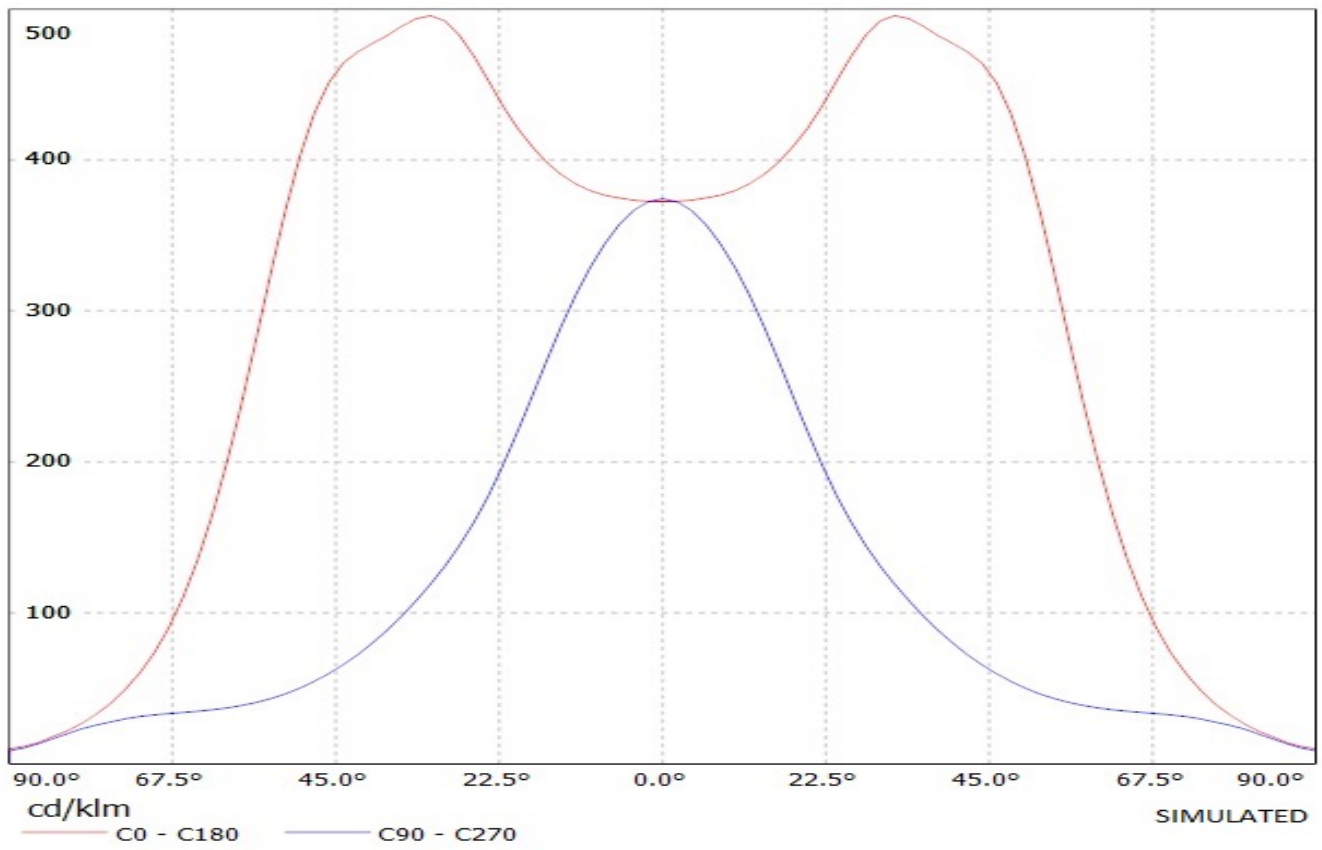

# Ledil Oy C10926\_Strada-B-XP C10926\_Strada-B-XP / LDC (Linear)

Luminaire: Ledil Oy C10926\_Strada-B-XP C10926\_Strada-B-XP  
Lamps: 1 x Cree XP-E (white)

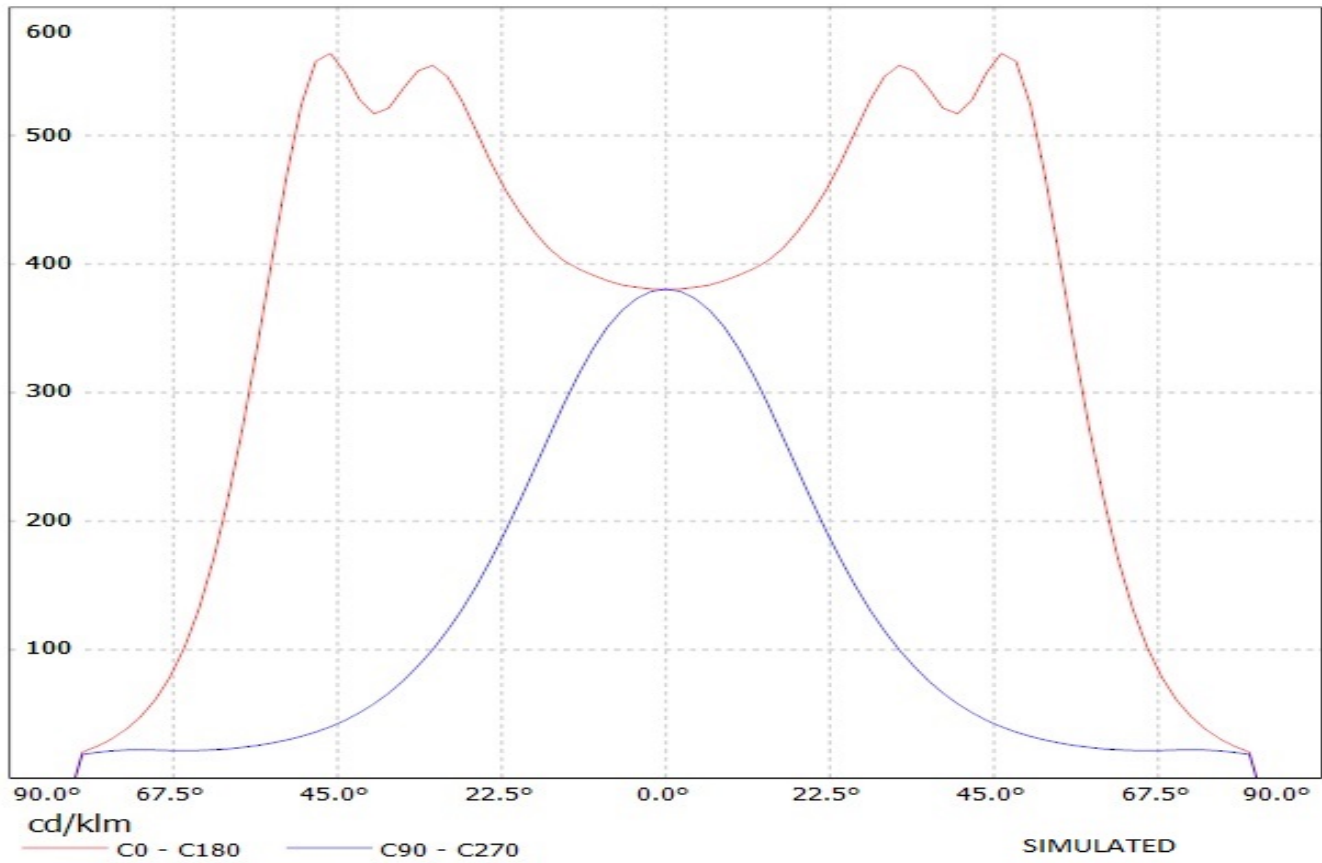

# Ledil Oy C10926\_Strada-B-XPG C10926\_Strada-B-XPG / LDC (Polar)

Luminaire: Ledil Oy C10926\_Strada-B-XPG C10926\_Strada-B-XPG  
Lamps: 1 x Cree XP-G (White)

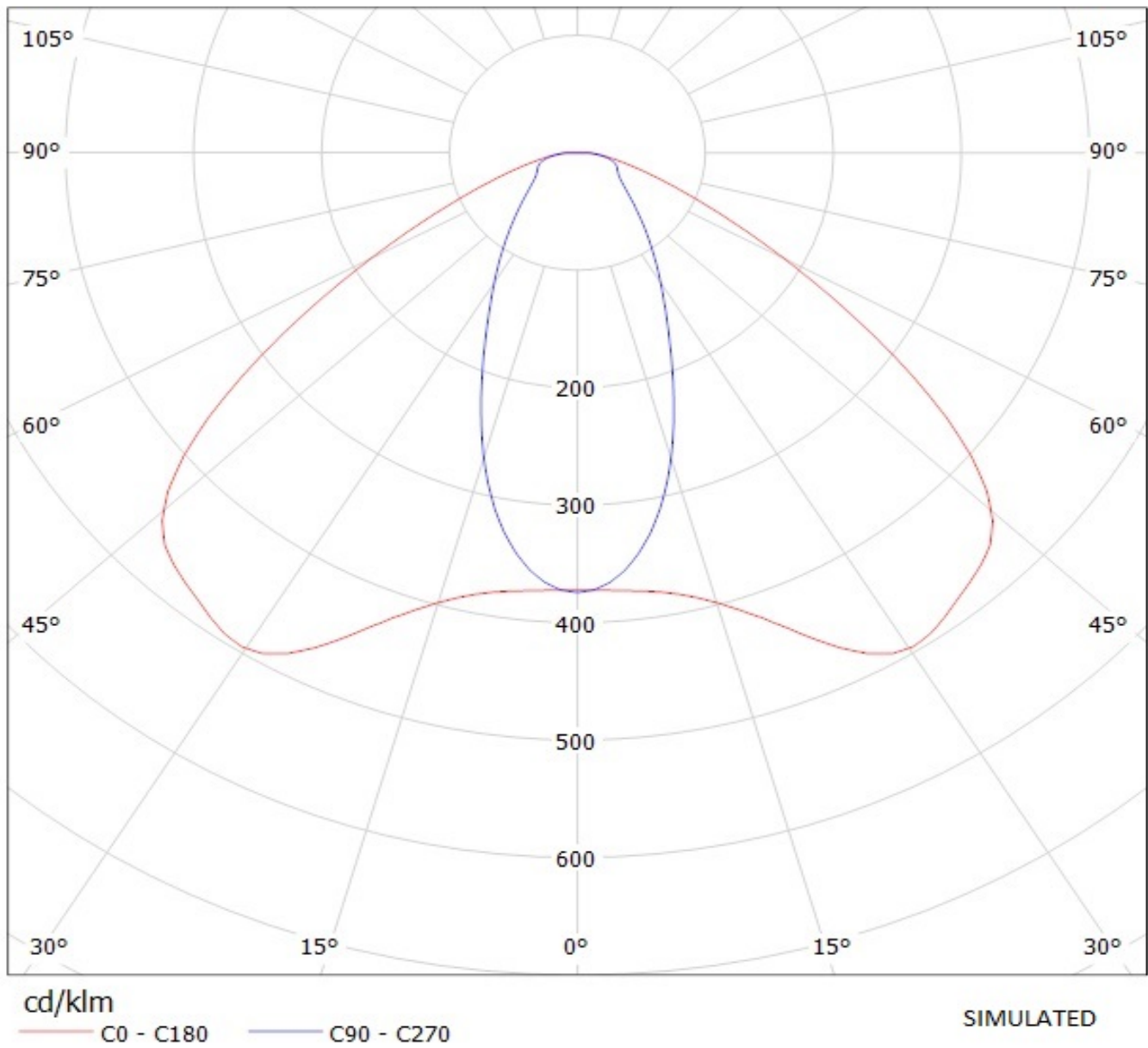

# Ledil Oy C10926\_Strada-B-XP C10926\_Strada-B-XP / LDC (Polar)

Luminaire: Ledil Oy C10926\_Strada-B-XP C10926\_Strada-B-XP  
Lamps: 1 x Cree XP-E (white)

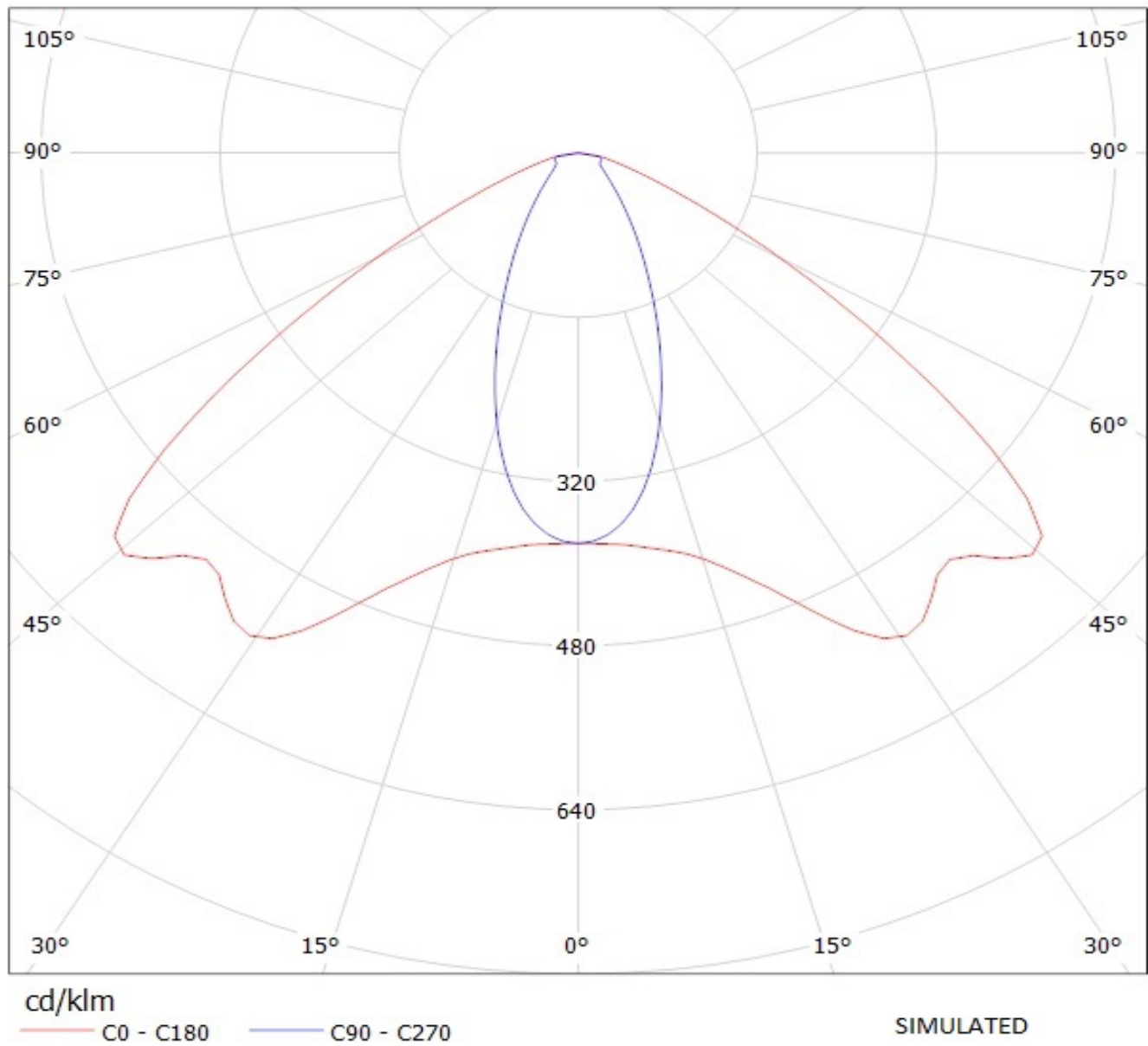

**NOTE: The typical divergence will be changed by different color, chip size and chip position tolerance. The typical total divergence is the full angle measured where the luminous intensity is half of the peak value.**