



C3D16060D

Silicon Carbide Schottky Diode

Z-REC™ RECTIFIER

V_{RRM}	=	600 V
$I_F (T_C=135^\circ\text{C})$	=	22 A**
Q_c	=	42 nC**

Features

- 600-Volt Schottky Rectifier
- Zero Reverse Recovery Current
- Zero Forward Recovery Voltage
- High-Frequency Operation
- Temperature-Independent Switching Behavior
- Extremely Fast Switching
- Positive Temperature Coefficient on V_F

Benefits

- Replace Bipolar with Unipolar Rectifiers
- Essentially No Switching Losses
- Higher Efficiency
- Reduction of Heat Sink Requirements
- Parallel Devices Without Thermal Runaway

Applications

- Switch Mode Power Supplies
- Power Factor Correction
- Solar Inverters
- Motor Drives
- Electric Vehicle Charger

Package

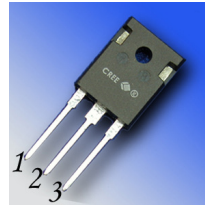

TO-247-3

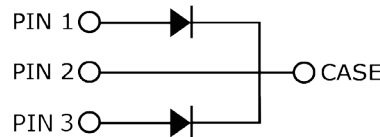

Part Number	Package	Marking
C3D16060D	TO-247-3	C3D16060

Maximum Ratings ($T_C=25^\circ\text{C}$ unless otherwise specified)

Symbol	Parameter	Value	Unit	Test Conditions	Note
V_{RRM}	Repetitive Peak Reverse Voltage	600	V		
V_{RSM}	Surge Peak Reverse Voltage	600	V		
V_{DC}	DC Blocking Voltage	600	V		
I_F	Continuous Forward Current (Per Leg/Device)	23/46 11/22 8/16	A	$T_C=25^\circ\text{C}$ $T_C=135^\circ\text{C}$ $T_C=150^\circ\text{C}$	See Fig. 3
I_{FRM}	Repetitive Peak Forward Surge Current (Per Leg/Device)	57/114 36/72	A	$T_C=25^\circ\text{C}$, $t_p=10$ ms, Half Sine Wave, $D=0.3$ $T_C=110^\circ\text{C}$, $t_p=10$ ms, Half Sine Wave, $D=0.3$	
I_{FSM}	Non-Repetitive Peak Forward Surge Current (Per Leg/Device)	80/160 60/120	A	$T_C=25^\circ\text{C}$, $t_p=10$ ms, Half Sine Wave, $D=0.3$ $T_C=110^\circ\text{C}$, $t_p=10$ ms, Half Sine Wave, $D=0.3$	
I_{FSM}	Non-Repetitive Peak Forward Surge Current (Per Leg/Device)	220/440	A	$T_C=25^\circ\text{C}$, $t_p=10$ μs , Pulse	
P_{tot}	Power Dissipation (Per Leg)	100* 43*	W	$T_C=25^\circ\text{C}$ $T_C=110^\circ\text{C}$	
T_J, T_{stg}	Operating Junction and Storage Temperature	-55 to +175	$^\circ\text{C}$		
	TO-247 Mounting Torque	1 8.8	Nm lbf-in	M3 Screw 6-32 Screw	

* Per Leg, ** Per Device

Electrical Characteristics (Per Leg)

Symbol	Parameter	Typ.	Max.	Unit	Test Conditions	Note
V_F	Forward Voltage	1.6 1.9	1.8 2.4	V	$I_F = 8\text{ A}$ $T_J = 25^\circ\text{C}$ $I_F = 8\text{ A}$ $T_J = 175^\circ\text{C}$	
I_R	Reverse Current	10 20	50 200	μA	$V_R = 600\text{ V}$ $T_J = 25^\circ\text{C}$ $V_R = 600\text{ V}$ $T_J = 175^\circ\text{C}$	
Q_C	Total Capacitive Charge	21		nC	$V_R = 600\text{ V}$, $I_F = 8\text{ A}$ $di/dt = 500\text{ A}/\mu\text{s}$ $T_J = 25^\circ\text{C}$	
C	Total Capacitance	441 39 33		pF	$V_R = 0\text{ V}$, $T_J = 25^\circ\text{C}$, $f = 1\text{ MHz}$ $V_R = 200\text{ V}$, $T_J = 25^\circ\text{C}$, $f = 1\text{ MHz}$ $V_R = 400\text{ V}$, $T_J = 25^\circ\text{C}$, $f = 1\text{ MHz}$	

Note:

1. This is a majority carrier diode, so there is no reverse recovery charge.

Thermal Characteristics

Symbol	Parameter	Typ.	Unit
$R_{\theta JC}$	Thermal Resistance from Junction to Case	1.5 * 0.75 **	$^\circ\text{C}/\text{W}$

* Per Leg, ** Per Device

Typical Performance (Per Leg)

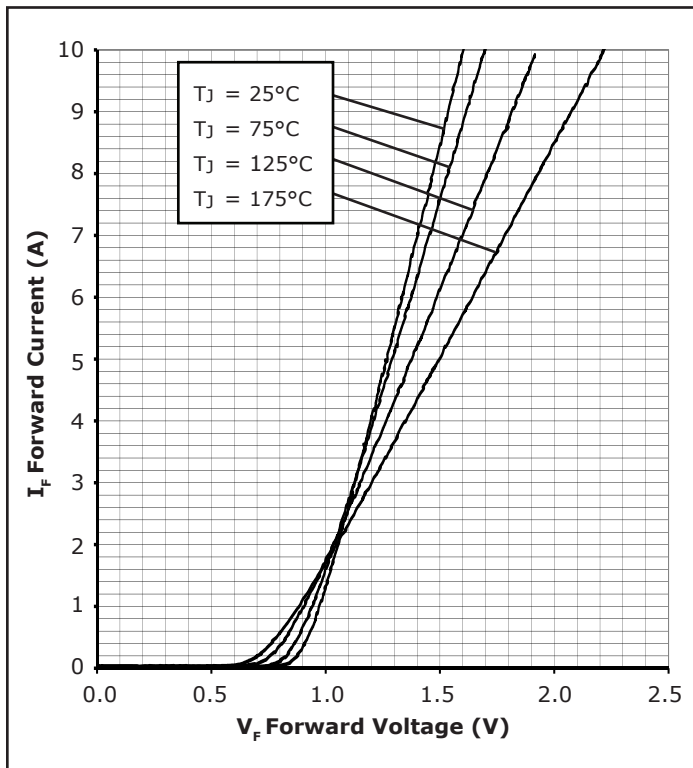

Figure 1. Forward Characteristics

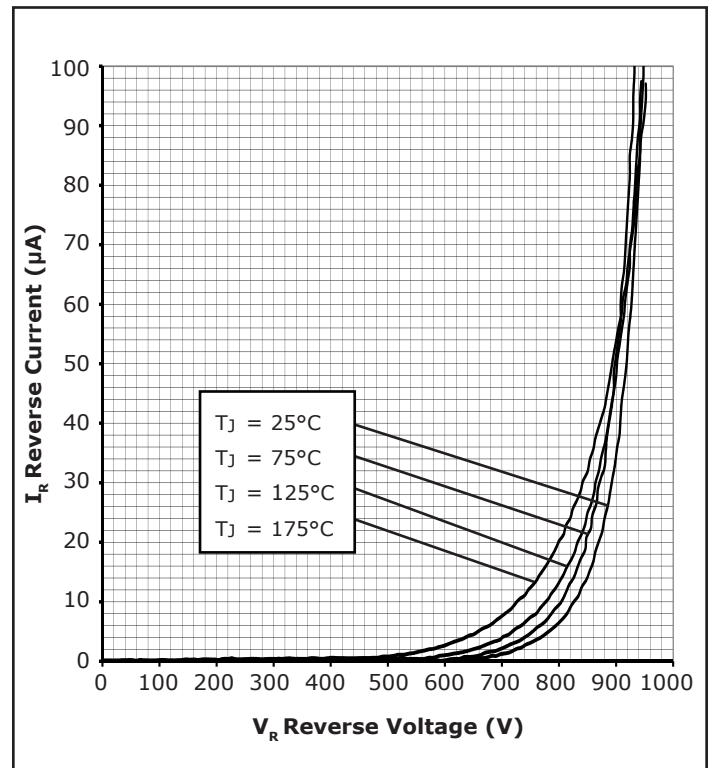

Figure 2. Reverse Characteristics

Typical Performance (Per Leg)

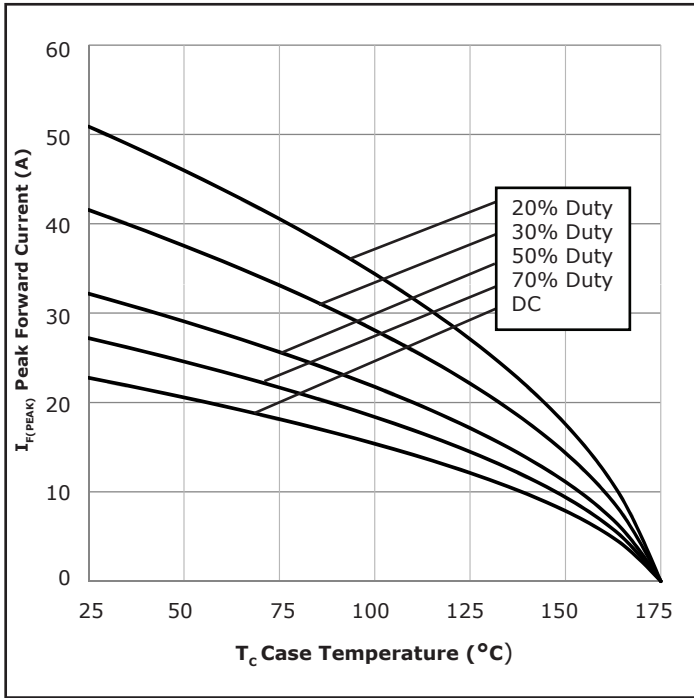

Figure 3. Current Derating

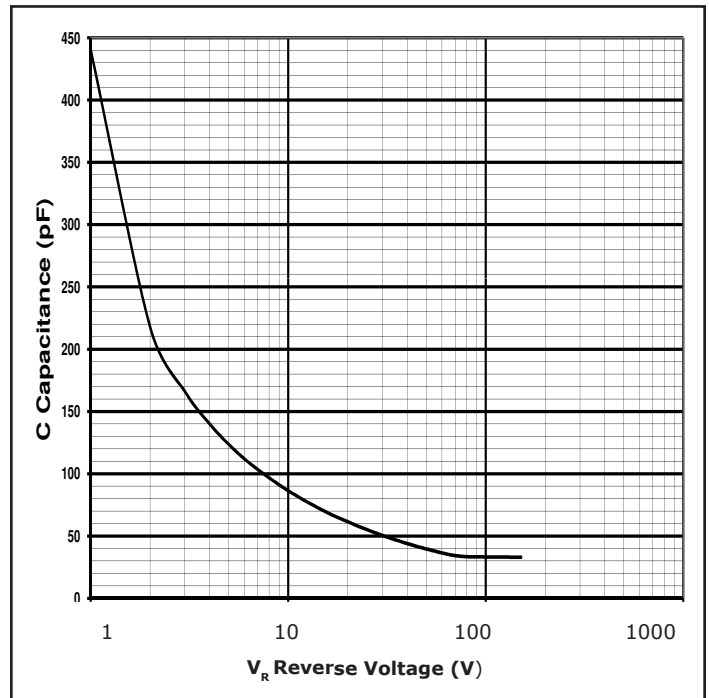

Figure 4. Capacitance vs. Reverse Voltage

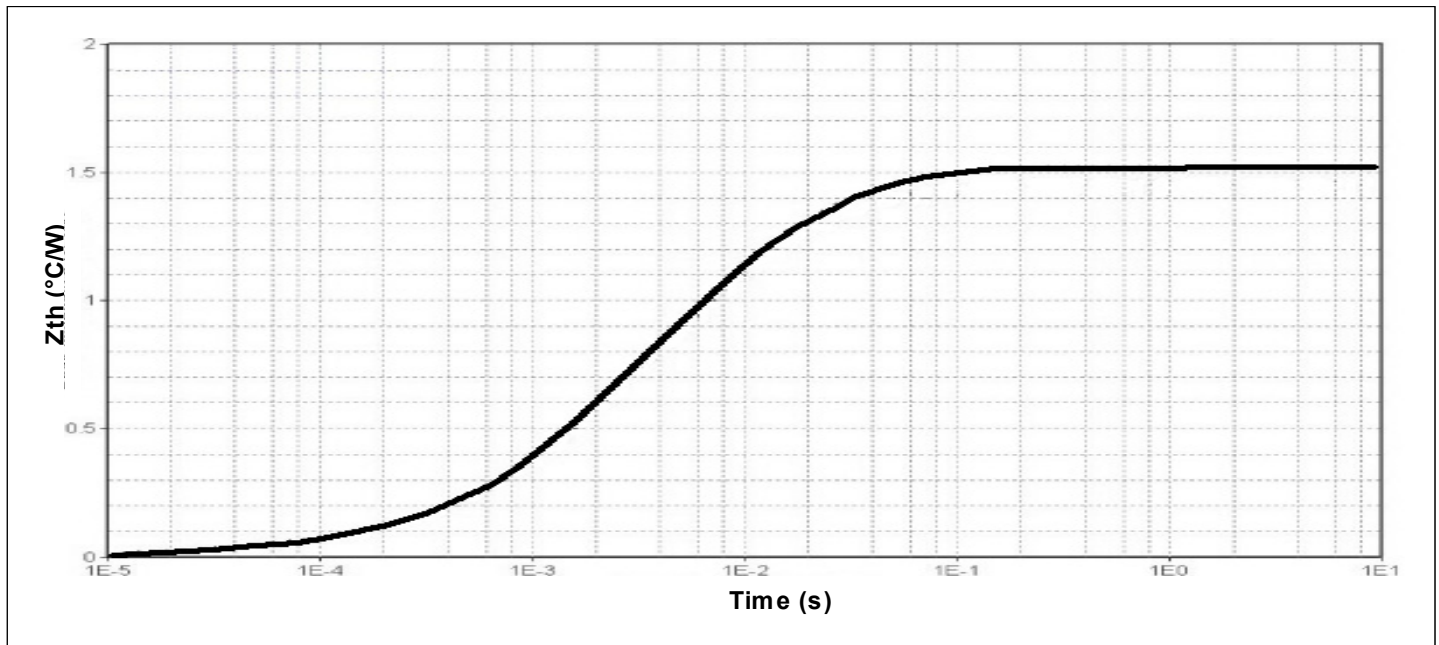

Figure 5. Transient Thermal Impedance

Typical Performance (Per Leg)

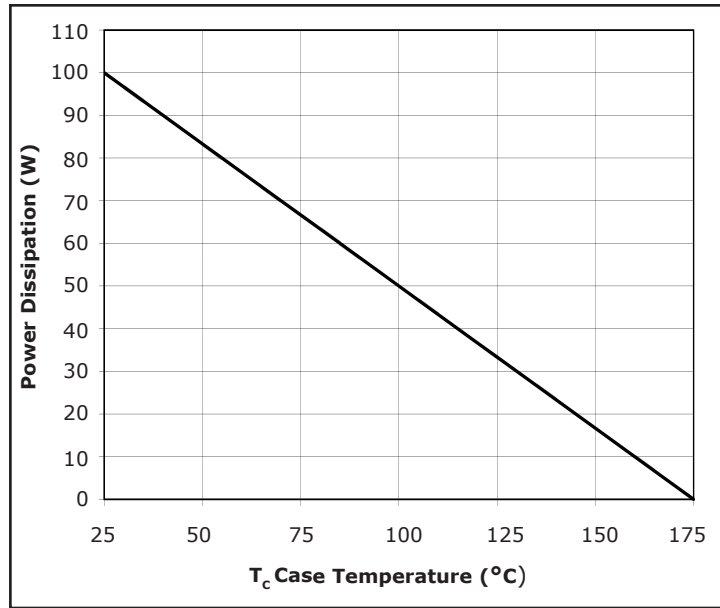
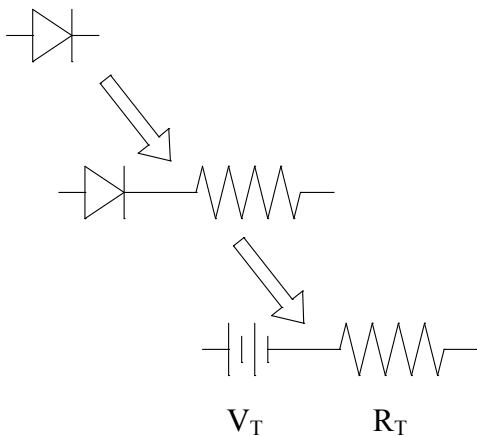

Figure 6. Power Derating

Diode Model (Per Leg)



$$V_{f_T} = V_T + I_f \cdot R_T$$

$$V_T = 0.93 + (T_j \cdot -9.3 \cdot 10^{-4})$$

$$R_T = 0.058 + (T_j \cdot 5.7 \cdot 10^{-4})$$

Note: T_j = Diode Junction Temperature In Degrees Celsius

Package Dimensions

Package TO-247-3

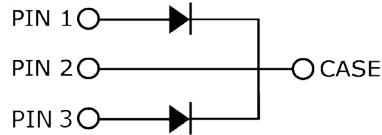
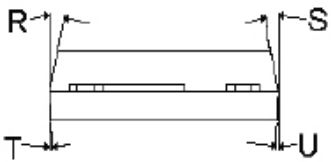
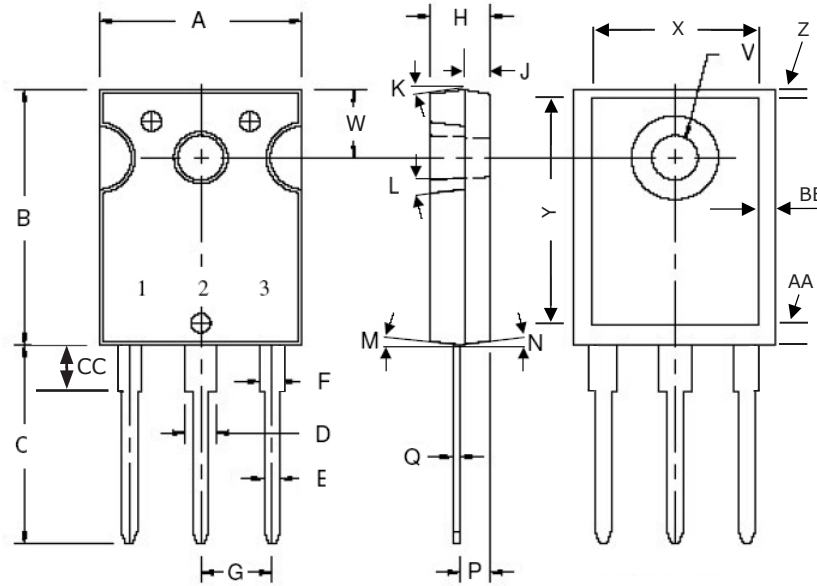

POS	Inches		Millimeters	
	Min	Max	Min	Max
A	.605	.635	15.367	16.130
B	.800	.831	20.320	21.10
C	.780	.800	19.810	20.320
D	.095	.133	2.413	3.380
E	.046	.052	1.168	1.321
F	.060	.095	1.524	2.410
G	.215 TYP		5.460 TYP	
H	.175	.205	4.450	5.210
J	.075	.085	1.910	2.160
K	6°	21°	6°	21°
L	4°	6°	4°	6°
M	2°	4°	2°	4°
N	2°	4°	2°	4°
P	.090	.100	2.286	2.540
Q	.020	.030	.508	.762
R	9°	11°	9°	11°
S	9°	11°	9°	11°
T	2°	8°	2°	8°
U	2°	8°	2°	8°
V	.137	.144	3.487	3.658
W	.210	.248	5.334	6.300
X	.502	.557	12.751	14.150
Y	.637	.695	16.180	17.653
Z	.038	.052	0.964	1.321
AA	.110	.140	2.794	3.556
BB	.030	.046	0.766	1.168
CC	.161	.176	4.100	4.472

Recommended Solder Pad Layout

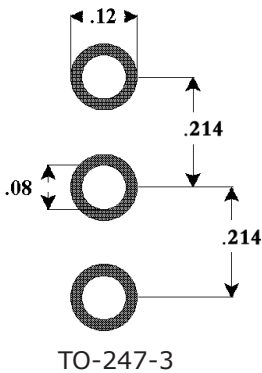

Part Number	Package	Marking
C3D16060D	TO-247-3	C3D16060

Note: Recommended soldering profiles can be found in the applications note here: <http://www.cree.com/~media/Files/Cree/Power/Application%20Notes/CPWRAN04A.pdf>





Notes

- **RoHS Compliance**

The levels of RoHS restricted materials in this product are below the maximum concentration values (also referred to as the threshold limits) permitted for such substances, or are used in an exempted application, in accordance with EU Directive 2011/65/EC (RoHS2), as implemented January 2, 2013. RoHS Declarations for this product can be obtained from your Cree representative or from the Product Documentation sections of www.cree.com.

- **REACH Compliance**

REACH substances of high concern (SVHCs) information is available for this product. Since the European Chemical Agency (ECHA) has published notice of their intent to frequently revise the SVHC listing for the foreseeable future, please contact a Cree representative to insure you get the most up-to-date REACH SVHC Declaration. REACH banned substance information (REACH Article 67) is also available upon request.

- This product has not been designed or tested for use in, and is not intended for use in, applications implanted into the human body nor in applications in which failure of the product could lead to death, personal injury or property damage, including but not limited to equipment used in the operation of nuclear facilities, life-support machines, cardiac defibrillators or similar emergency medical equipment, aircraft navigation or communication or control systems, or air traffic control systems.