

BN 1078

Locking and sealing rings

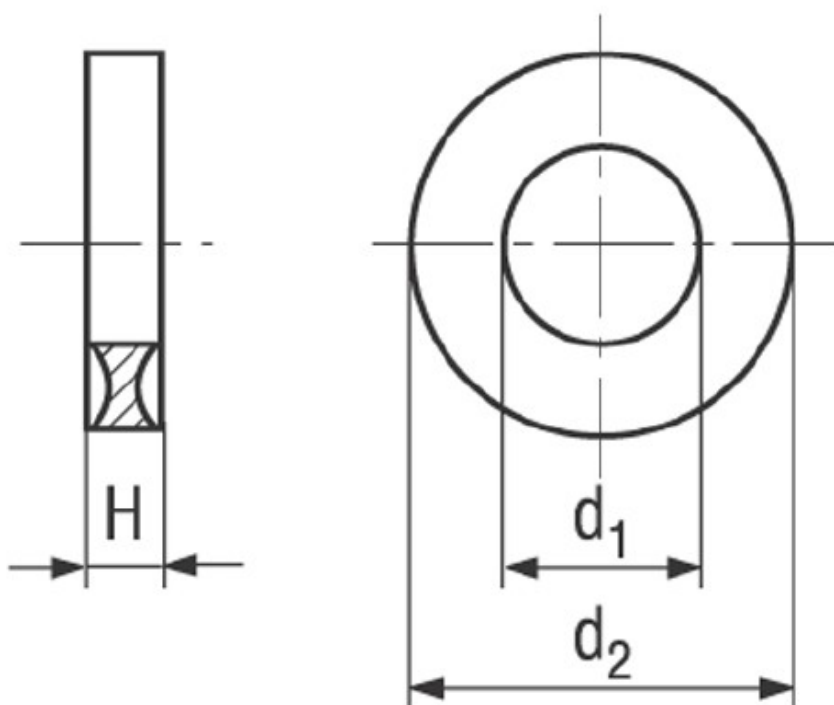

Trade mark	Dubo®	Color	white
Material	Polyamide 6	Quality	PA 6

Article No. - 1405365

for thread	M6
Ww	1/4"
d ₁	6,5
d ₂	12,7
H	3,5

Important: For screws 8.8 and larger use toothed lock washers BN 1080.
Operating temperature range: -60 °C to +80 °C.