

BN 2724 - DIN 7500 C

Cross recessed pan head thread forming screws
type C, Pozidriv Z, metric thread
case-hardened

DIN 7500 C

~UNI 8112

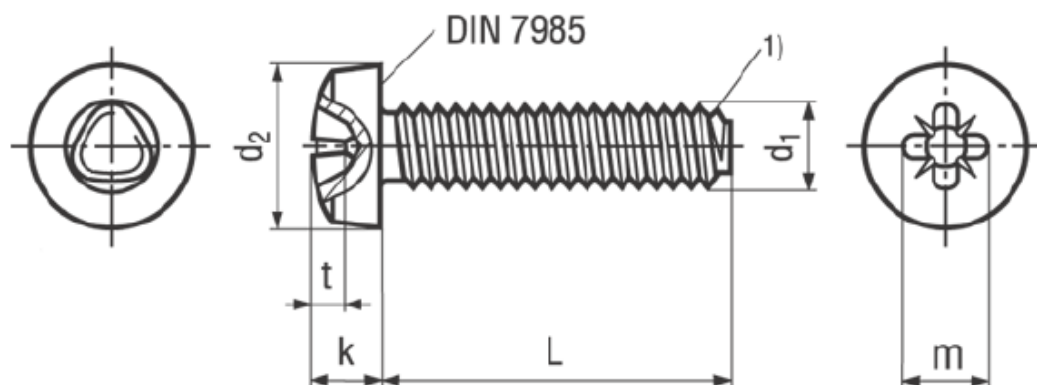

Material	Steel	Hardness	450-550 HV
Surface	zinc plated blue		

Article No. - 1473956	
d ₁	M6
L	25
d ₂ max.	12
k max.	4,75
Pozidriv	3
m~	6,7
t min.	3,02
t max.	3,48

Tapered thread end max. 4P

Screwdriver Bits 1/4": BN 31514 and BN 31516 / CG 1

Fasteners steel case-hardened with electroplated coatings: Susceptible to hydrogen embrittlement!