

## BN 11252

Hexagon socket button head screws  
with flange

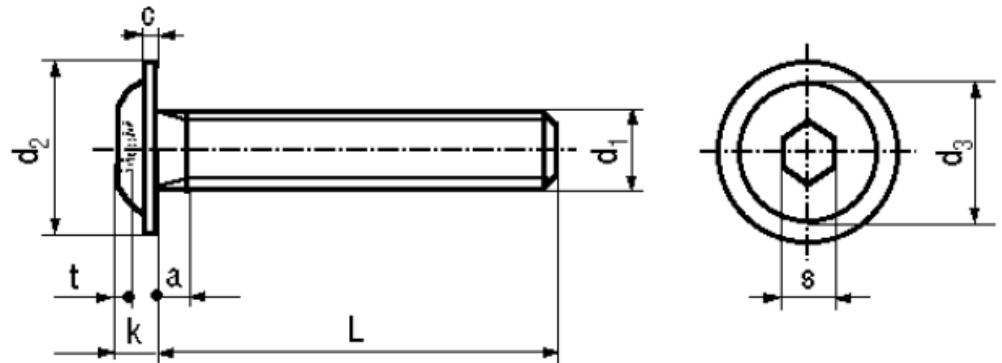

Material	Steel	Quality	~010.9
Surface	black		

### Article No. - 2042134

d <sub>1</sub>	M5
L	20
d <sub>2</sub> max.	11,6
d <sub>3</sub> ~	9,2
k max.	2,8
c~	1
a max.	1,6
t min.	1,8
s	3