

BN 797 - DIN 137 A

Curved spring washers

DIN 137 A
~UNI 8840 A

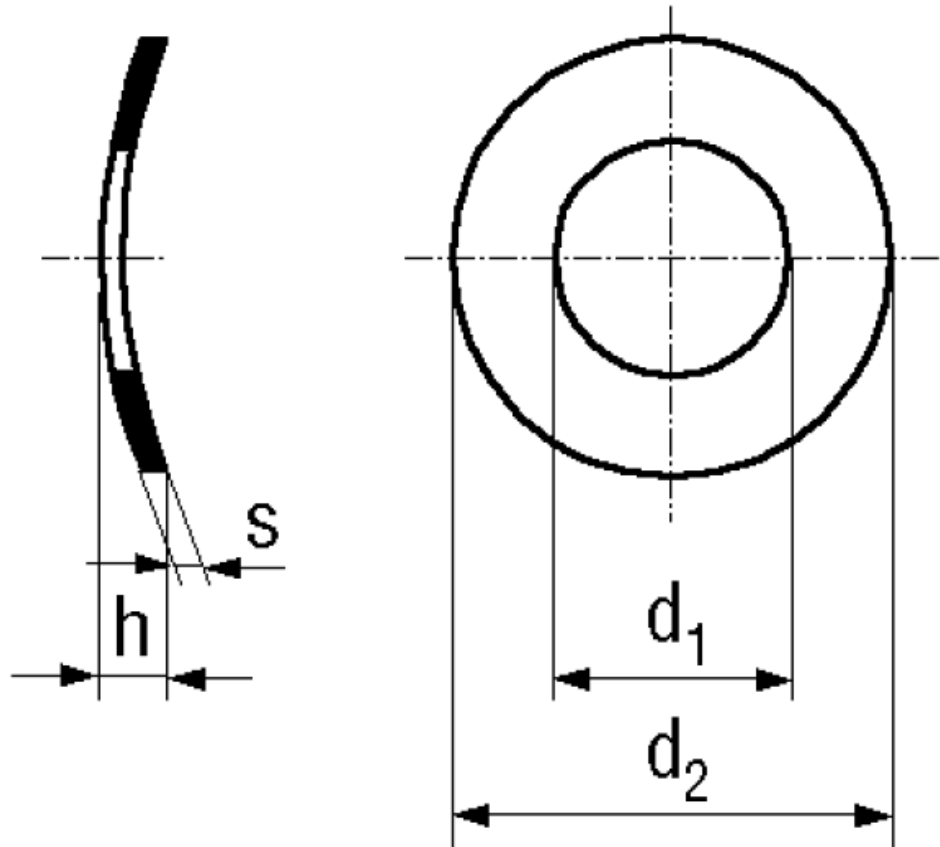

Type	A	Surface	mechanical zinc plated blue
Material	Spring steel	Hardness	430-530 HV

Article No. - 1280473

for thread	M5
d_1	5,3
d_2	10
h min.	0,9
s	0,5

Form A is no longer in force. We recommend DIN 137 B for new constructions.

Alternative:

Depending on the technical manufacturing possibilities, spring steel elements are equally available with an inorganic or mechanical zinc-plating (availability, prices and delivery periods on request). These procedures exclude the risk of varied breakage due to hydrogen brittleness, his being liable to appear in acid baths or during electroplating (zinc-plating).