

BN 373

Slotted flat countersunk head screws
small head

VSM 13328

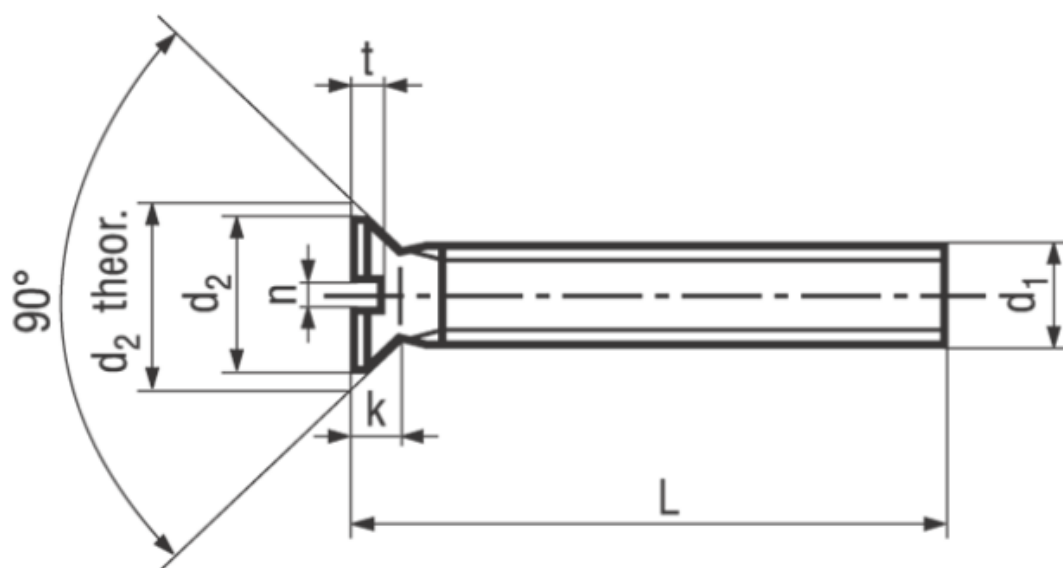

Material	Steel	Tensile strength	400 N/mm²
Surface	zinc plated blue	Elongation after fracture	min. 14%
Quality	4.8		

Article No. - 1149237

d ₁	M5
L	6
d ₂ theor.	8,6
d ₂ min.	7,8
k max.	1,8
n	1
t min.	0,8

All lengths fully threaded.