

BN 833

Circlips
for shaft without groove

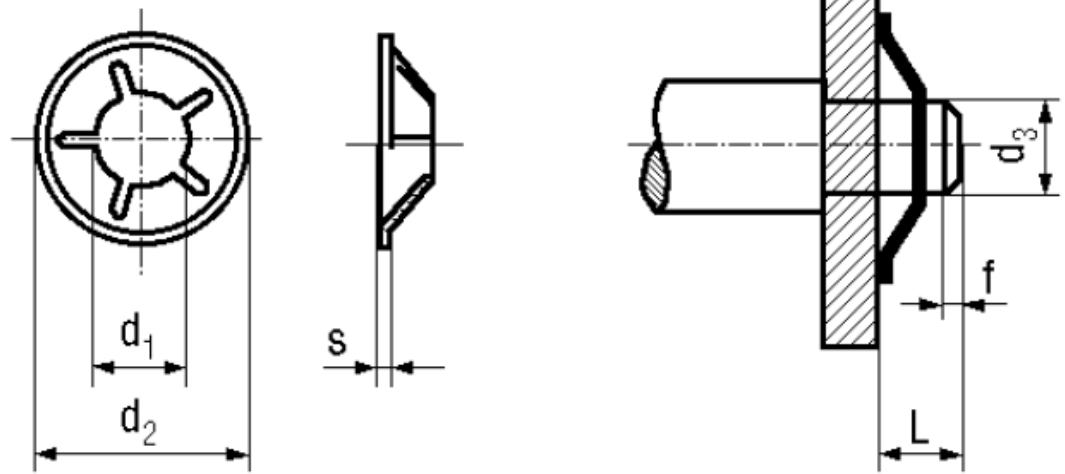

Trade mark	Quicklock®	Material	Spring steel
Type	BQ	Surface	black

Article No. - 1292862	
d_3 h9	4
d_1	3,75
d_2	12
s	0,3
L min.	2,5
L max.	7
f max.	0,3

d3: Provided that the stated load is not fully utilized tol. h9 may be replaced by h11.

Number of lock tabs at manufacturer's option..