

BN 677 - DIN 137 A

Curved spring washers

DIN 137 A
~UNI 8840 A

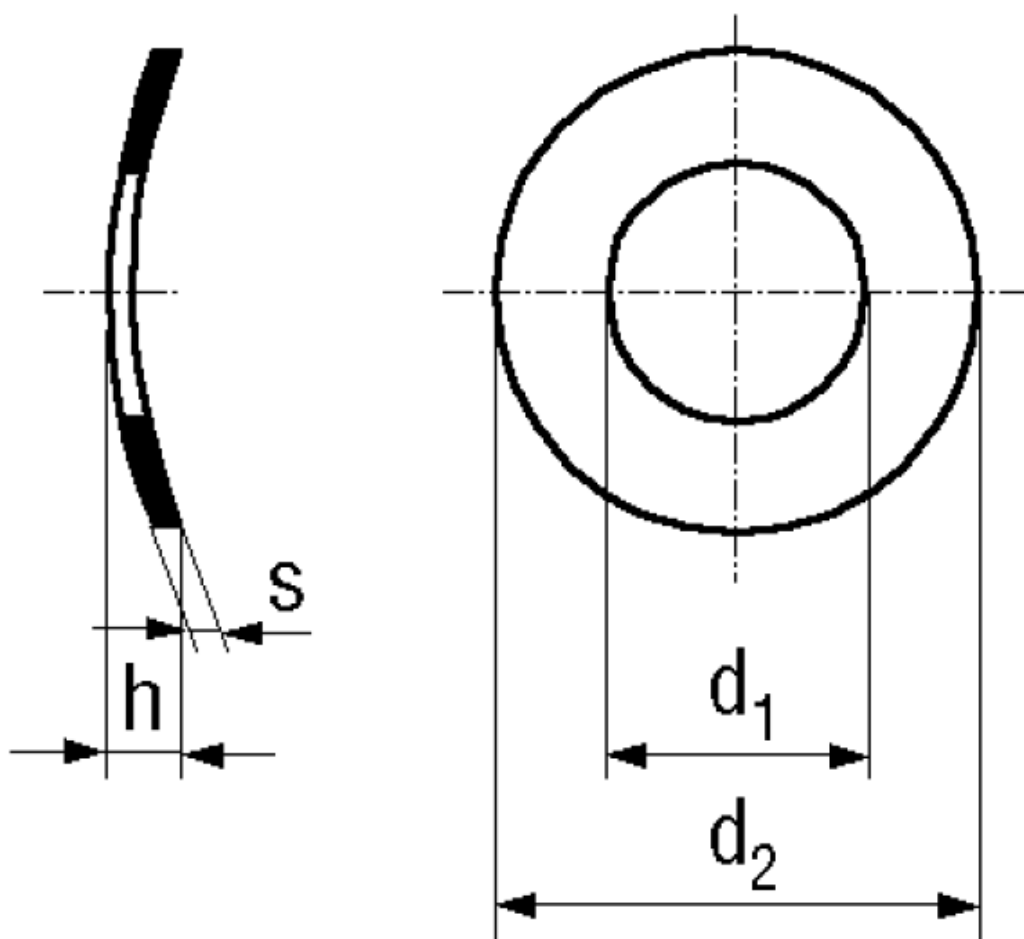

Material	Stainless steel	Quality	A2 / 1.4310
----------	-----------------	---------	-------------

Article No. - 1250140	
for thread	M4
d_1	4,3
d_2	8
h min.	0,8
s	0,5

Form A is no longer in force. We recommend DIN 137 B for new constructions.
Material: at manufacturer's option.