

BN 654

Slotted flat countersunk head screws

DIN 963 A
~ISO 2009
~UNI 6109

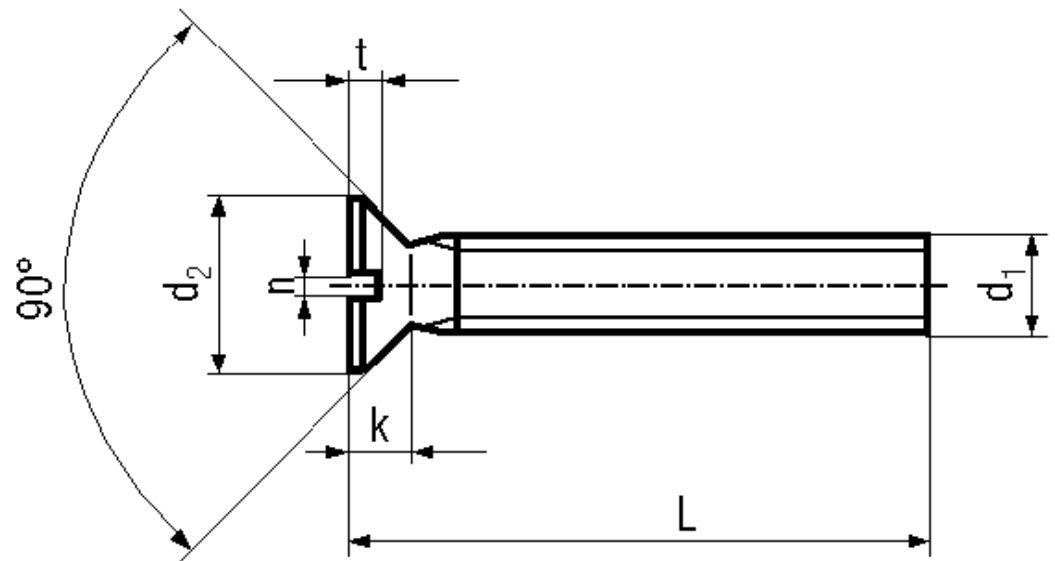

Material Quality

Article No. - 1246801

d ₁	M4
L	8
d ₂	7,5
k max.	2,2
n	1
t min.	0,8

DIN 963: Standard withdrawn

All lengths fully threaded.

Slotted flat countersunk head screws with small head VSM 13328: BN 658