

BN 373

Slotted flat countersunk head screws
small head

VSM 13328

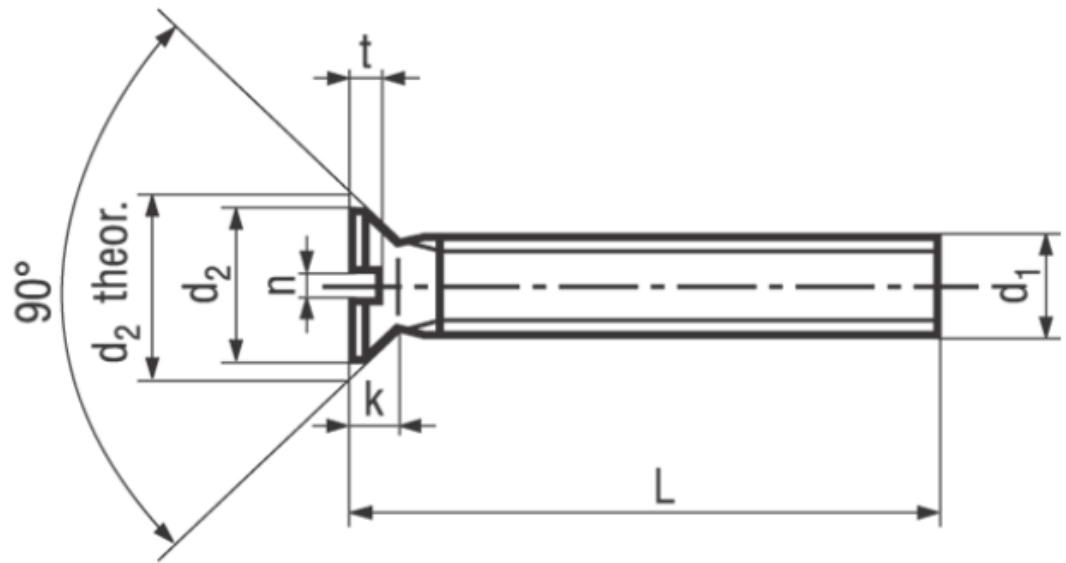

Material	Steel	Tensile strength	400 N/mm²
Surface	zinc plated blue	Elongation after fracture	min. 14%
Quality	4.8		

Article No. - 1149121

d ₁	M4
L	8
d ₂ theor.	6,4
d ₂ min.	5,8
k max.	1,2
n	0,8
t min.	0,6

All lengths fully threaded.