

BN 363

Slotted flat countersunk head screws

DIN 963 A
~ISO 2009
~UNI 6109

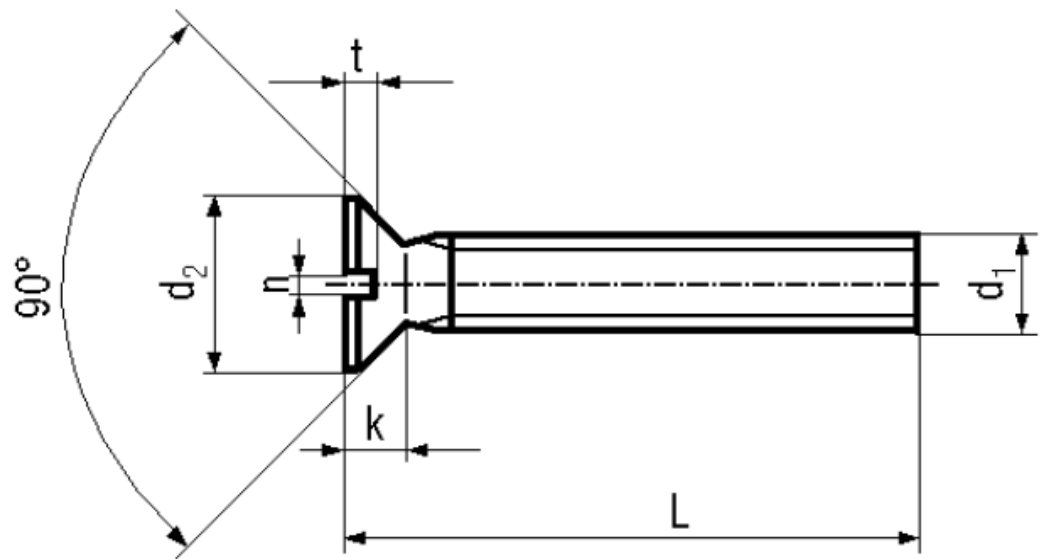

Material	Steel	Tensile strength	800 N/mm²
Surface	zinc plated blue	Proof stress 0,2%	640 N/mm²
Quality	8.8	Elongation after fracture	min. 12%

Article No. - 1144227

d ₁	M4
L	30
d ₂ max.	7,5
k max.	2,2
n	1
t min.	0,8
Proof load (N)	5100

DIN 963 A: Standard withdrawn
All lengths fully threaded.