

BN 1878 - DIN 7504 N - ~ISO 15481

Cross recessed pan head self-drilling screws
 Phillips H, type N
 case-hardened

DIN 7504 N
 ~ISO 15481
 ~UNI 8118

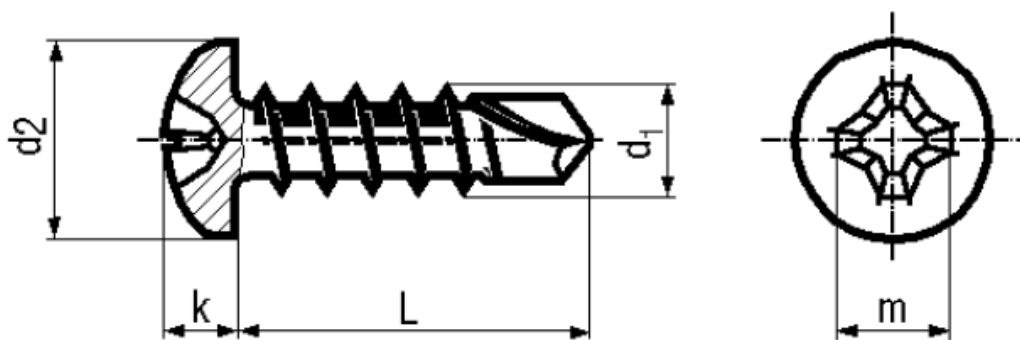

Trade mark	eco-drill™	Surface	zinc plated blue
Material	Steel	Hardness	560 HV

Article No. - 1394568

d ₁	ST 4,8
L	13
d ₂	9,5
k max.	3,55
Phillips	2
m~	5

DIN 7504: Standard withdrawn

Shaped drilling head.

Screwdriver Bits 1/4": BN 31515 and BN 10639 / CG 1.

Fasteners steel case-hardened ≥ 320 HV with electroplated coatings: Susceptible to hydrogen embrittlement!