

BN 729 - DIN 9021 - ~ISO 7093

Flat washers
without chamfer

DIN 9021
~ISO 7093
~UNI 6593

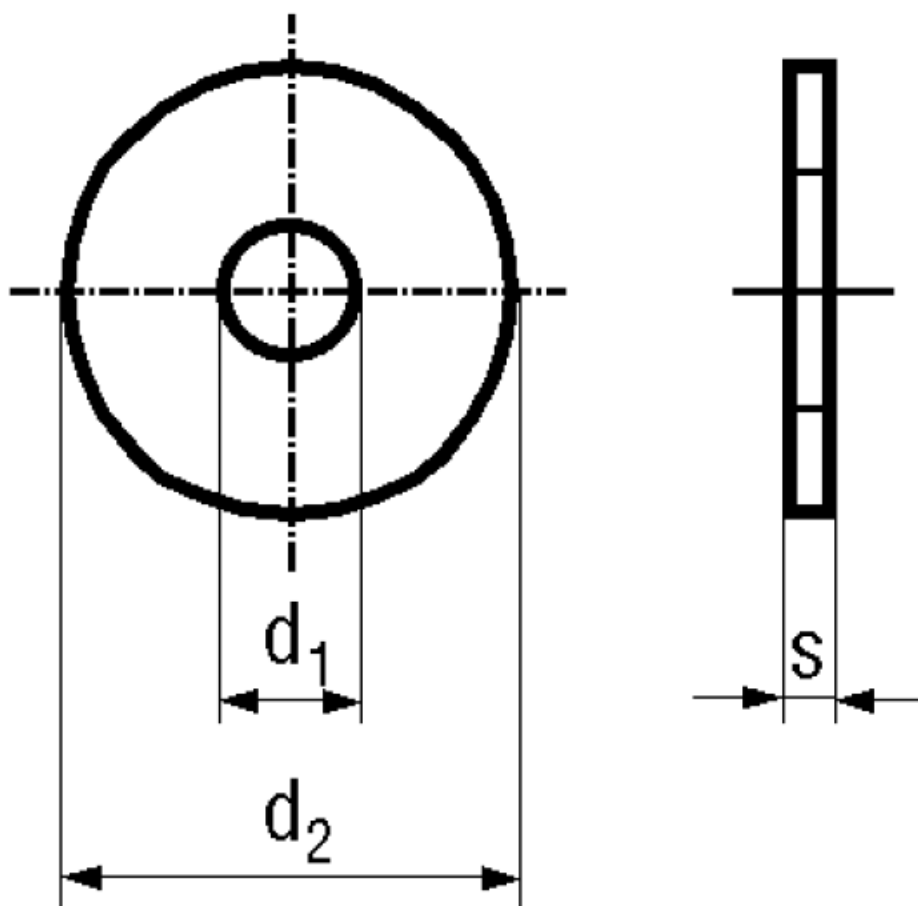

Material	Steel	Hardness	140 HV / 100 HV
Surface	zinc plated blue	Hardness grade	140 HV for \leq M16 (Product grade A), 100 HV for $>$ M16 (Product grade C)

Article No. - 1269976

for thread	M3
d_1	3,2
d_2	9
s	0,8

DIN 9021: Standard withdrawn