

BN 4879

Finishing washers
for 90° countersunk head screws

SN 213912

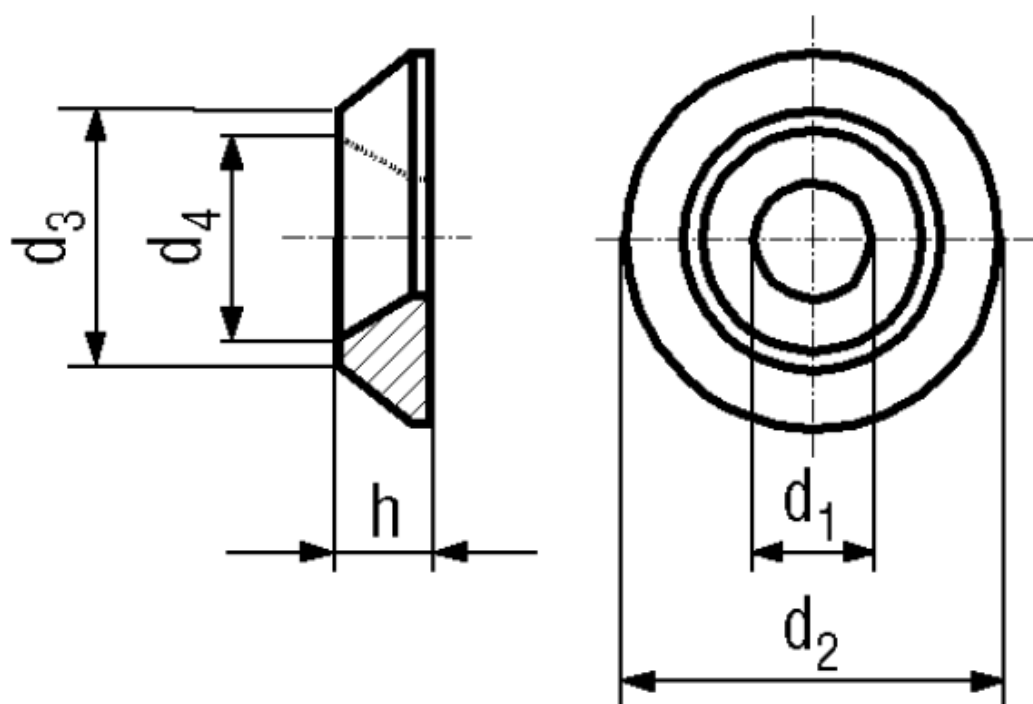

Material	Stainless steel	Quality	A1
----------	-----------------	---------	----

Article No. - 1184156

fit for	M3
d ₁ min.	3,2
d ₂ max.	10
d ₃	7,3
d ₄ min.	6,5
h min.	1,8