

BN 654

Slotted flat countersunk head screws

DIN 963 A
~ISO 2009
~UNI 6109

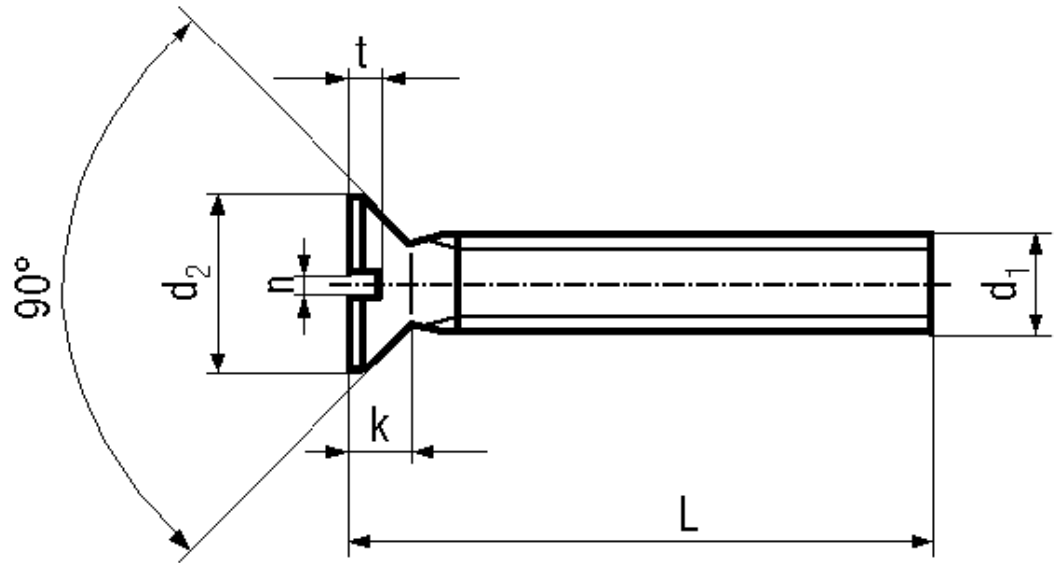

Material	Stainless steel	Quality	A2
----------	-----------------	---------	----

Article No. - 1246739

d ₁	M3
L	8
d ₂	5,6
k max.	1,65
n	0,8
t min.	0,6

DIN 963: Standard withdrawn

All lengths fully threaded.

Slotted flat countersunk head screws with small head VSM 13328: BN 658