

BN 357

Slotted flat countersunk head screws

DIN 963 A
~ISO 2009
~UNI 6109

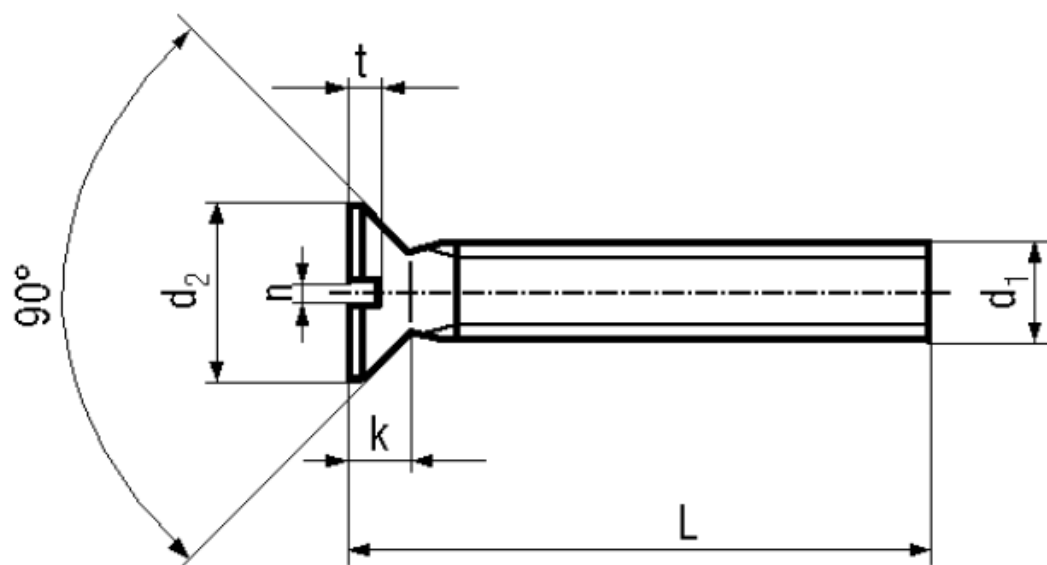

Material	Steel	Tensile strength	400 N/mm²
Surface	zinc plated blue	Elongation after fracture	min. 14%
Quality	4.8		

Article No. - 1140205

d ₁	M3
L	6
d ₂ max.	5,6
k max.	1,65
n	0,8
t min.	0,6

DIN 963 A: Standard withdrawn
All lengths fully threaded.