

BN 373

Slotted flat countersunk head screws
small head

VSM 13328

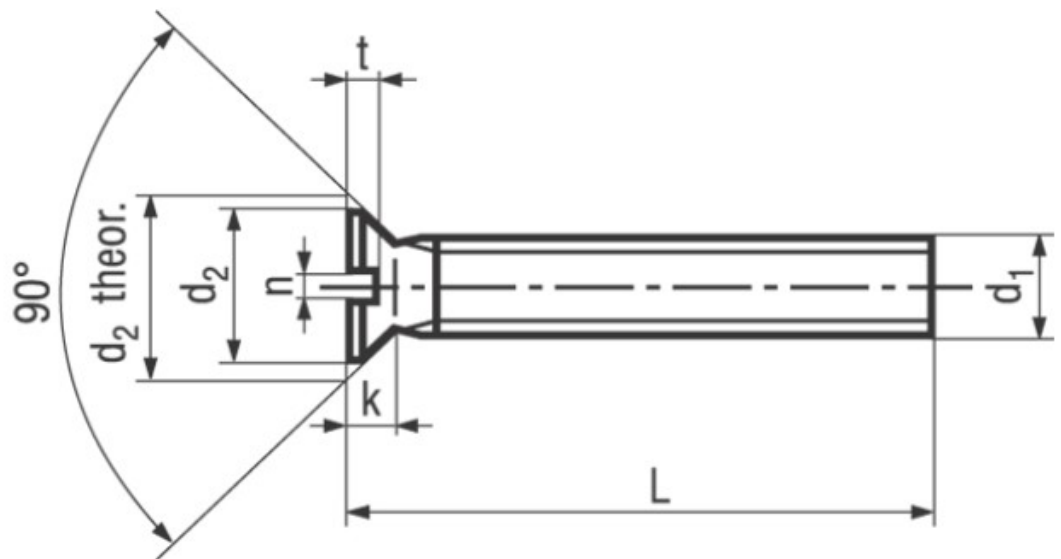

Material	Steel	Tensile strength	400 N/mm²
Surface	zinc plated blue	Elongation after fracture	min. 14%
Quality	4.8		

Article No. - 1148990

d ₁	M3
L	5
d ₂ theor.	4,9
d ₂ min.	4,3
k max.	0,95
n	0,6
t min.	0,5

All lengths fully threaded.