

BN 654

Slotted flat countersunk head screws

DIN 963 A
~ISO 2009
~UNI 6109

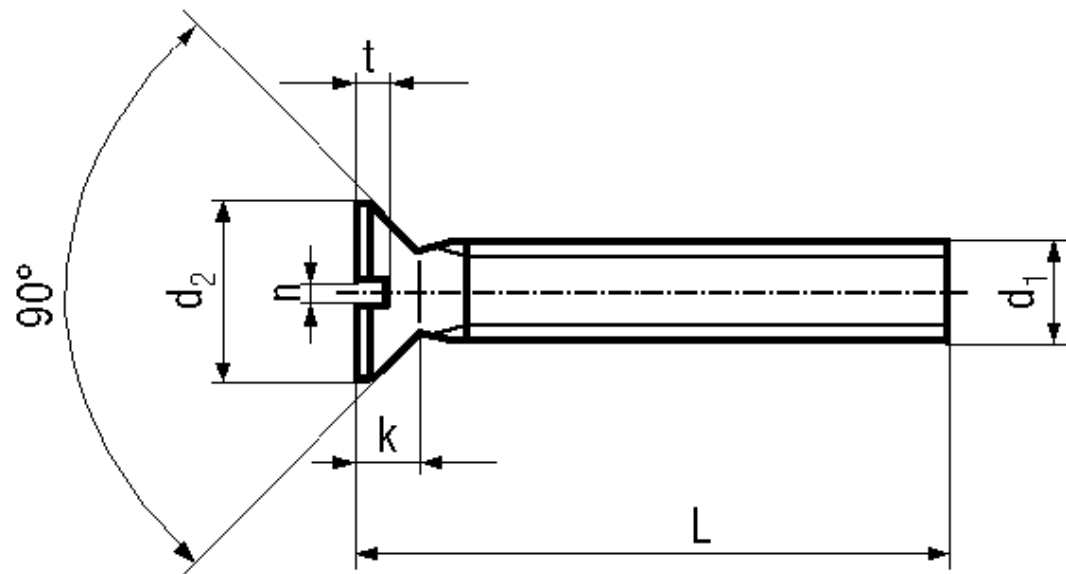

Material	Stainless steel	Quality	A2
----------	-----------------	---------	----

Article No. - 1427776

d_1	M1,6
L	3
d_2	3
k max.	0,96
n	0,4
t min.	0,32

DIN 963: Standard withdrawn

All lengths fully threaded.

Slotted flat countersunk head screws with small head VSM 13328: BN 658