

SWITCH CIRCUIT			MATERIAL AND FINISH AS BELOW						
WHEN CARD IS EJECTED		WHEN CARD IS INSERTED		A	Housing	LCP UL94V-0 Black	E		
				B	Contact	Phosphor Bronze C5210, Contact Area: Gold Flash	F		
				C	Latch	Stainless Steel SUS301	G		
				D			H		

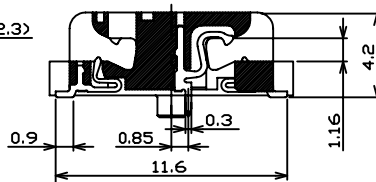
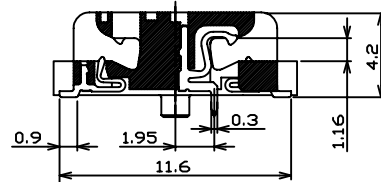
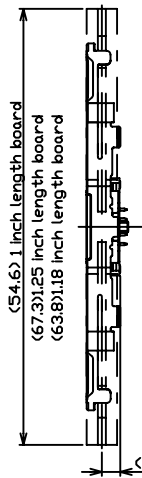
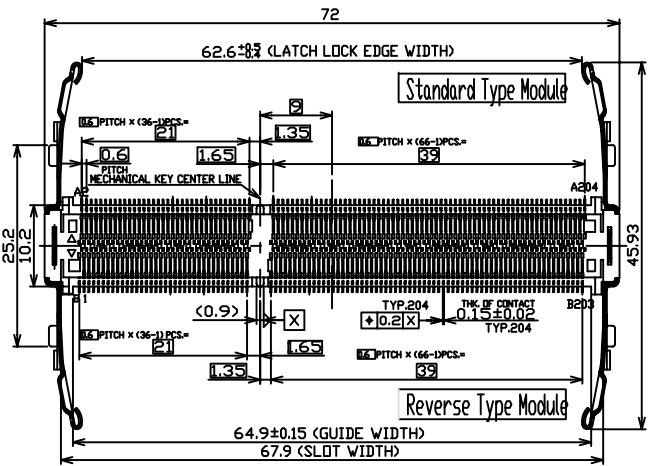

SPECIFICATION:

1. ELECTRICAL

- 1.1 Current Rating: 0.3A per pin
- 1.2 Voltage Rating: 25V AC/DC
- 1.3 Contact Resistance: 60mΩ
- 1.4 Insulation Resistance: 250MΩ
- 1.5 Dielectric Withstanding Voltage: 125VAC

2. MECHANICAL

- 2.1 Durability: 25 Cycle
- 2.2 Mating Force: 78.4N Max

3. ENVIRONMENTAL

- 3.1 Operating temperature range: -40°C~+85°C
- 3.2 Storage temperature range: -40°C~+85°C

4. SOLDER ABILITY

- 4.1 Recommended IR Reflow Temperature: 255°C 10Sec

P1	P2	P3	P4	P5	P6	P7	P8	P9	P10	P11	P12
----	----	----	----	----	----	----	----	----	-----	-----	-----

PIN ASSIGNMENT

122C-42A00 SO DIMM DDR3 Socket Dual Card Type 1.5V 204Pin 4.2H, Contact Area: Gold Flash

PRODUCT NO. DESCRIPTION

UNLESS OTHERWISE SPECIFIED TOLERANCE		
ANGLES	ANG.	±5°
LINEAR	0.	±0.3
	0.0	±0.25
	0.00	±0.20
SCALE	AS SHOWN	UNIT: mm
DRAWN	Willis	2012/12/05
CHECKED	Angel	2012/12/05
APPROVED	Ken	2012/12/05



www.attend.com.tw

DRAWN NAME: SO DIMM DDR3 Socket Dual Card Type 1.5V 204Pin 4.2H

PRODUCT NO. 122C-42A00

△	Revise:										
△	Revise:										
△	Revise:										

REV.	DESCRIPTION	DATE	REV.	DESCRIPTION	DATE	SIZE	REV.	FILE NAME
1						A4	1.0	122C-42A00_B_1

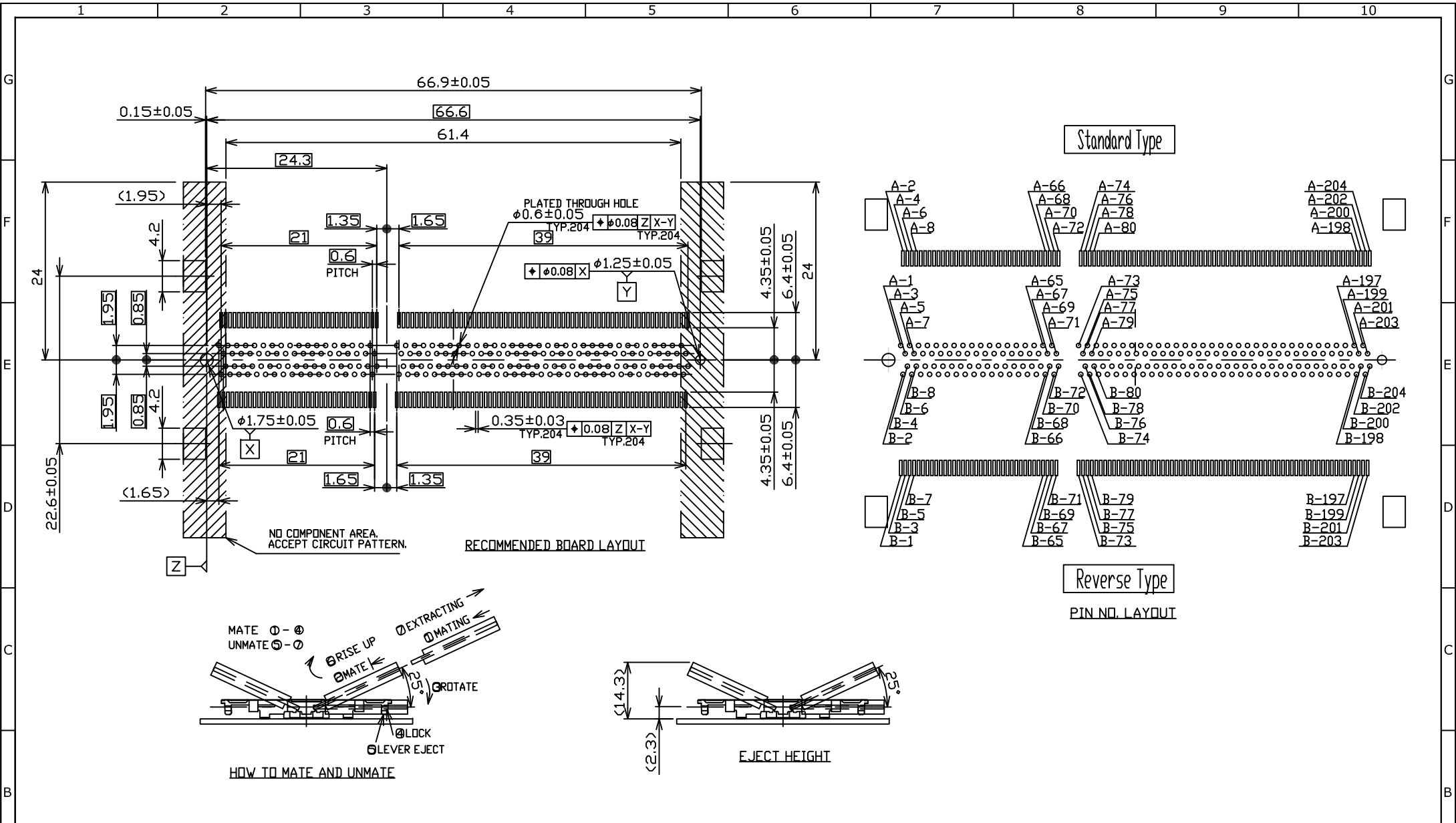

REV.	DESCRIPTION	DATE	REV.	DESCRIPTION	DATE	SIZE	REV.	FILE NAME
1			1			A4	1.0	122C-42A00_B_1

UNLESS OTHERWISE SPECIFIED TOLERANCE		
ANGLES	ANG.	±5°
LINEAR	0.	±0.3
	0.0	±0.25
	0.00	±0.20
SCALE	AS SHOWN	UNIT: mm
DRAWN	Willis	2012/12/05
CHECKED	Angel	2012/12/05
APPROVED	Ken	2012/12/05

www.attend.com.tw	
DRAWN NAME: SO DIMM DDR3 Socket	
Dual Card Type 1.5V 204Pin 4.2H	
PRODUCT NO.	122C-42A00



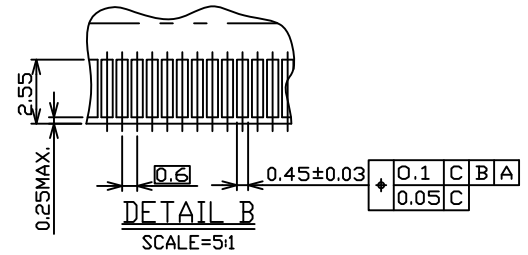
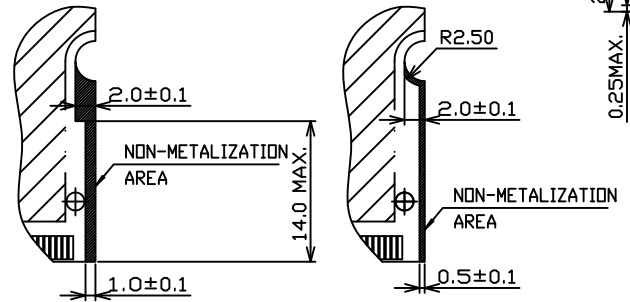
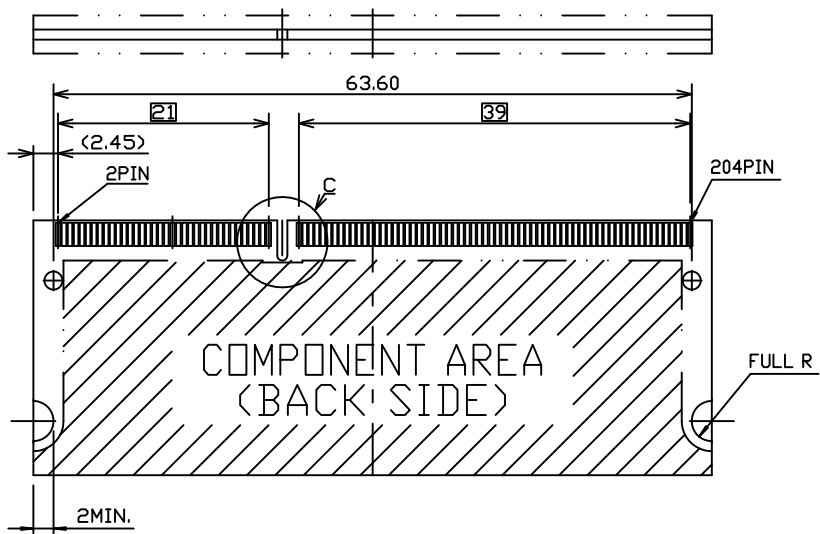
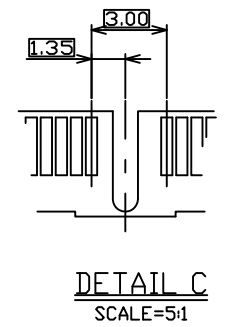
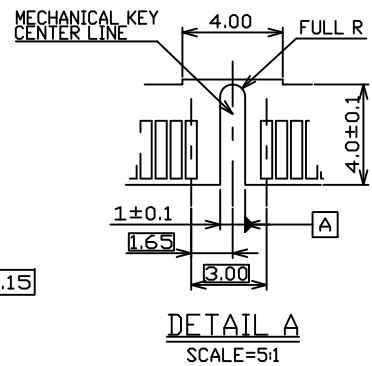
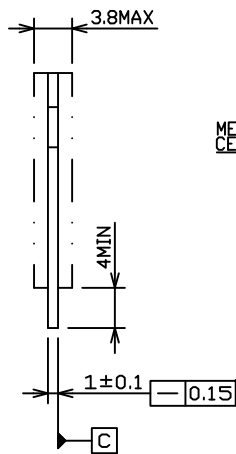
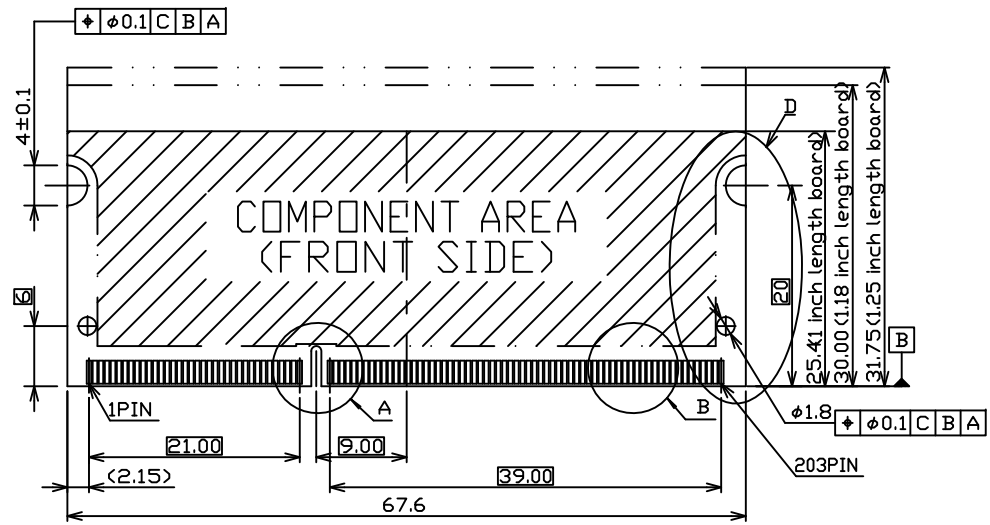

RECOMMENDED MATING
P.C. BOARD DIM.

REV.	DESCRIPTION	DATE	REV.	DESCRIPTION	DATE	SIZE	REV.	FILE NAME
1			4			A4	1.0	122C-42A00_B_1
			5					
			6					
			7					
			8					
			9					
			10					

UNLESS OTHERWISE SPECIFIED TOLERANCE		
ANGLES	ANG.	±5°
LINEAR	0.	±0.3
	0.0	±0.25
	0.00	±0.20
SCALE	AS SHOWN	UNIT: mm
DRAWN	Willis	2012/12/05
CHECKED	Angel	2012/12/05
APPROVED	Ken	2012/12/05



www.attend.com.tw
DRAWN NAME: SO DIMM DDR3 Socket
Dual Card Type 1.5V 204Pin 4.2H

PRODUCT NO. 122C-42A00
FILE NAME 122C-42A00_B_1

Revise:
Revise:
Revise:

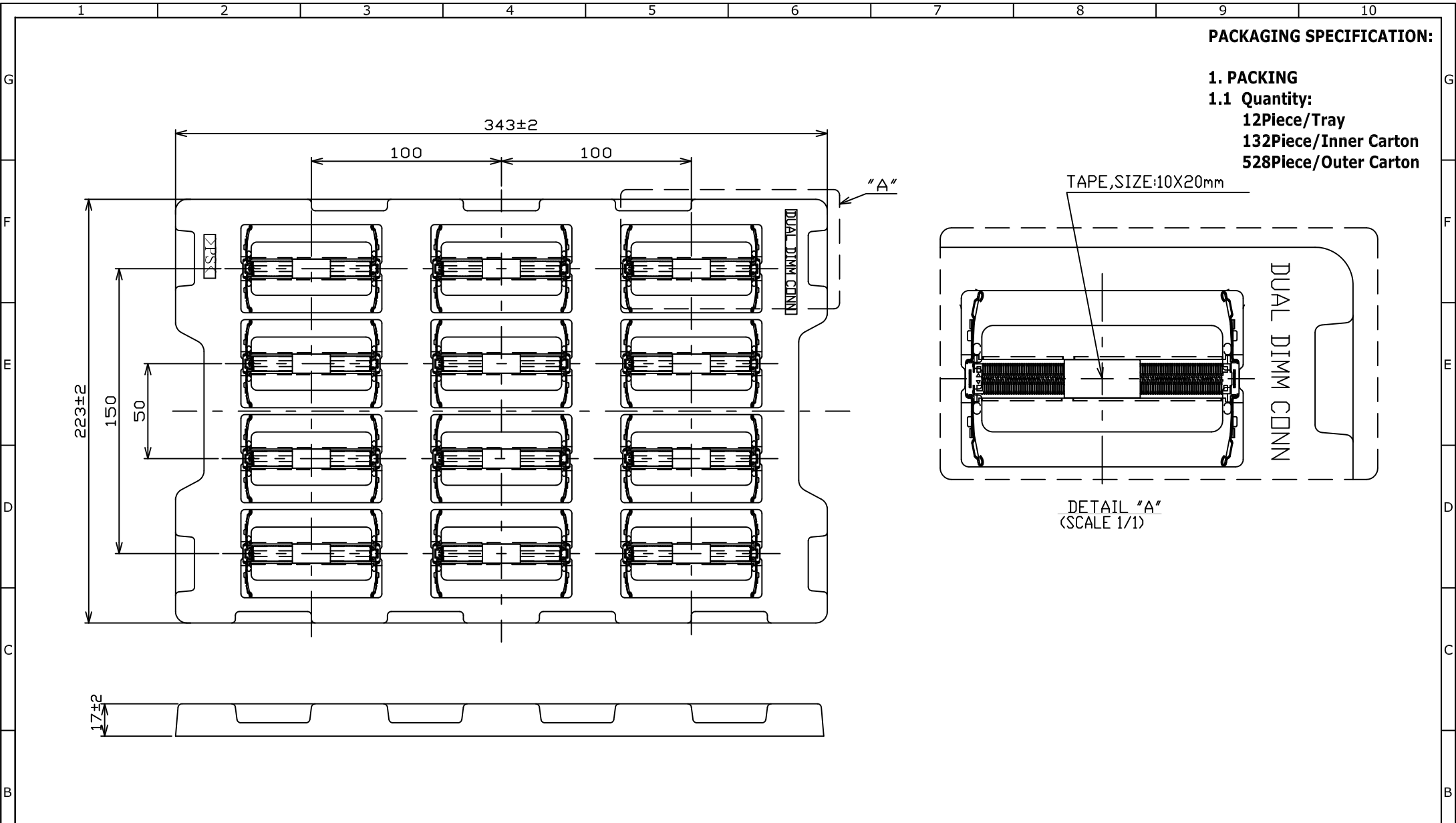

PACKAGING SPECIFICATION:

- 1. PACKING**
- 1.1 Quantity:**
- 12Piece/Tray**
- 132Piece/Inner Carton**
- 528Piece/Outer Carton**

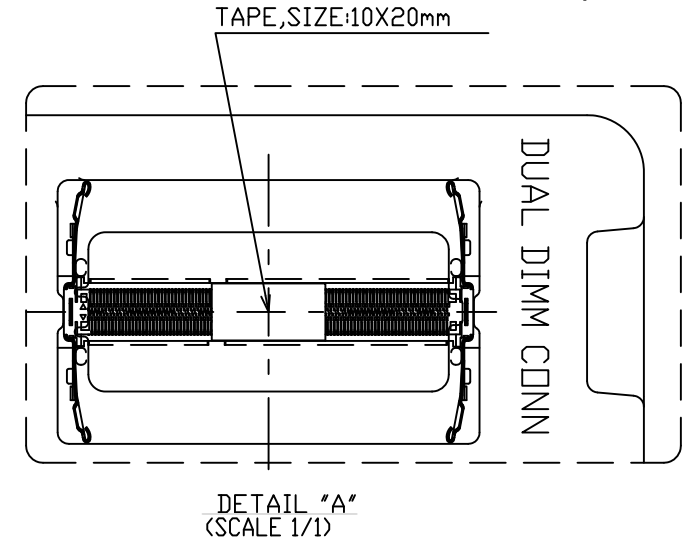

REV.	DESCRIPTION	DATE	REV.	DESCRIPTION	DATE	UNLESS OTHERWISE SPECIFIED TOLERANCE			 www.attend.com.tw
						ANGLES	ANG.	±5°	
						LINEAR	0.	±0.3	
							0.00	±0.25	
						SCALE	AS SHOWN	UNIT: mm	
						DRAWN	Willis	2012/12/05	
						CHECKED	Angel	2012/12/05	
						APPROVED	Ken	2012/12/05	
							SIZE	A4	
							REV.	1.0	
							FILE NAME	122C-42A00_D_1	

A	△	Revise:						DRAWN NAME:	SO DIMM DDR3 Socket Dual Card Type 1.5V 204Pin 4.2H
		Revise:						PRODUCT NO.	122C-42A00
		Revise:						FILE NAME	122C-42A00_D_1