

# APPROVAL SHEET

FREE ANTENNA

**RGFRA Series / Pb free**

2.4 GHz ISM Band Working Frequency

**P/N: RGFRA1204021A1T**

\*Contents in this sheet are subject to change without prior notice. ■

Preliminary Specification

FEATURES

1. Surface Mounted Devices with a small dimension of 12.0 x 4.0 x 2.0 mm<sup>3</sup>.
2. Embedded technology is able to future integrate with system design as well as beautifying the housing of final product.

APPLICATIONS

1. Bluetooth, ISM 2.4GHz in samrt phone, PDA and other handheld devices.
2. ISM band 2.4GHz applications

DESCRIPTION

Walsin Technology Corporation develops a new antenna specified for 2.4 GHz ISM Band application, as shown in below "CONSTRUCTION". It's application typically located on this unlicensed frequency band which range covers from 2.4GHz to 2.4835GHz.

CONSTRUCTION

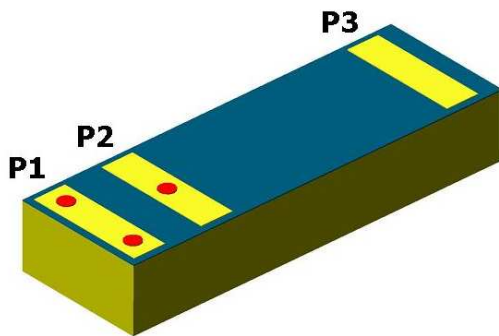

PIN	Definition
P1	GND
P2	Feed
P3	Soldering

Fig 1. Outline of Free Antenna – RGFRA1204021A1T

DIMENSUIONS

Figure	Dimension	Port definition	
<p>The figure shows a top-down view of the antenna with dimensions L (length), W (width), and T (thickness). It also shows a side view with dimensions Pw (pad width), P1, P2, and P3 (port widths). The top surface is labeled 'ANT1204-C3' and 'WTC'.</p>	L	12.0 ± 0.15 mm	-
	W	4.0 ± 0.15 mm	-
	T	2.0 ± 0.20 mm	-
	P <sub>w</sub>	3.6 ± 0.10 mm	Pad width
	P <sub>1</sub>	1.0 ± 0.10 mm	GND
	P <sub>2</sub>	1.0 ± 0.10 mm	Feed
	P <sub>3</sub>	1.0 ± 0.10 mm	Soldering terminal

**ELECTRICAL CHARACTERICS**

<b>RGFRA1204021A1T</b>	<b>Specification</b>
Working Frequency Range	2.4 GHz ~ 2.5GHz
Gain	2 dBi (Typical)
VSWR	2.0 max.
Polarization	Linear
Azimuth Bandwidth	Omni-directional
Impedance	50Ω
Operation Temperature	-40°C ~ +85°C

**Remark: The specification is defined based on the test board dimension as in below**

**Antenna on Test Board**

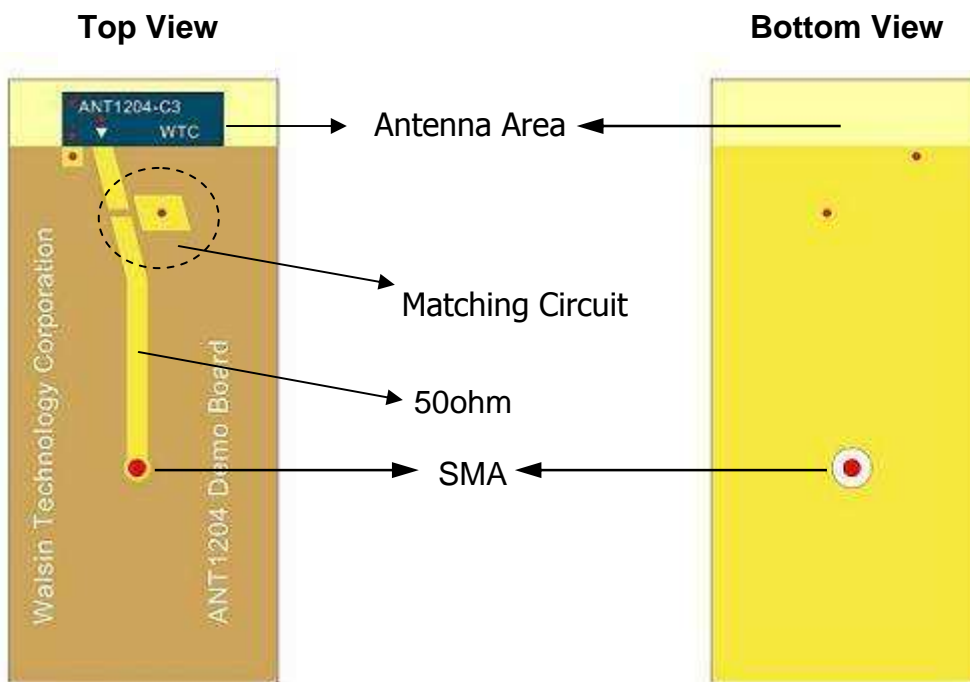

Antenna S11 on Test Board

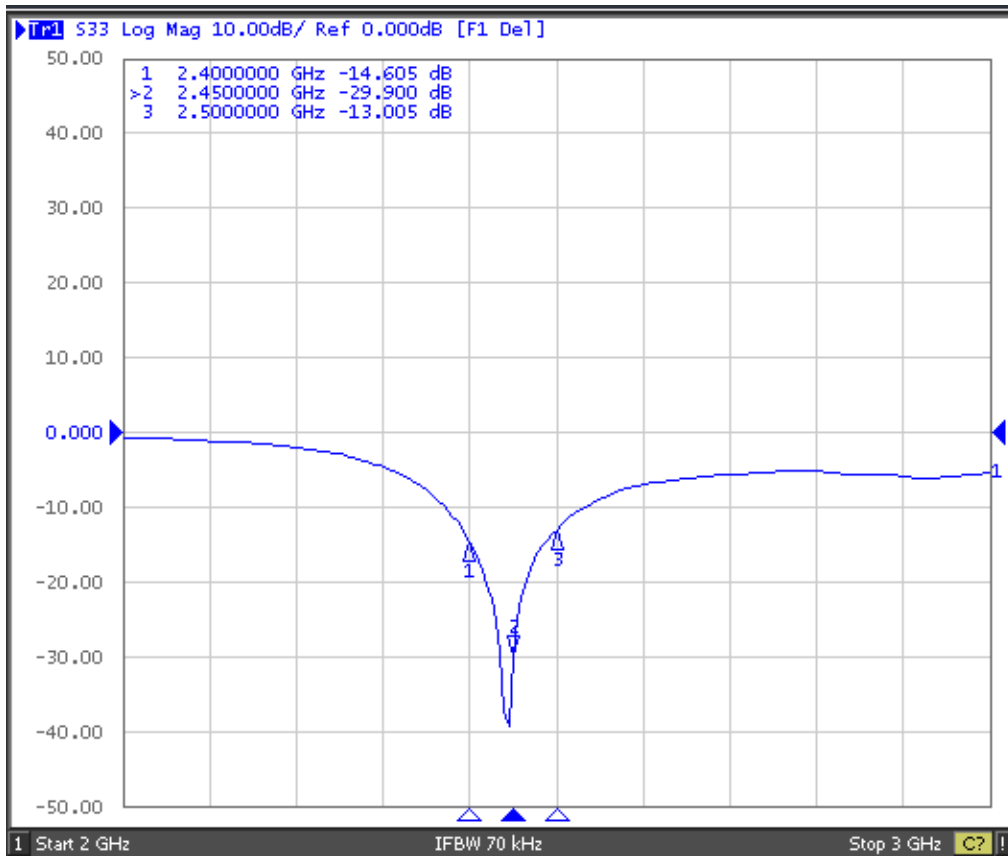

VSWR

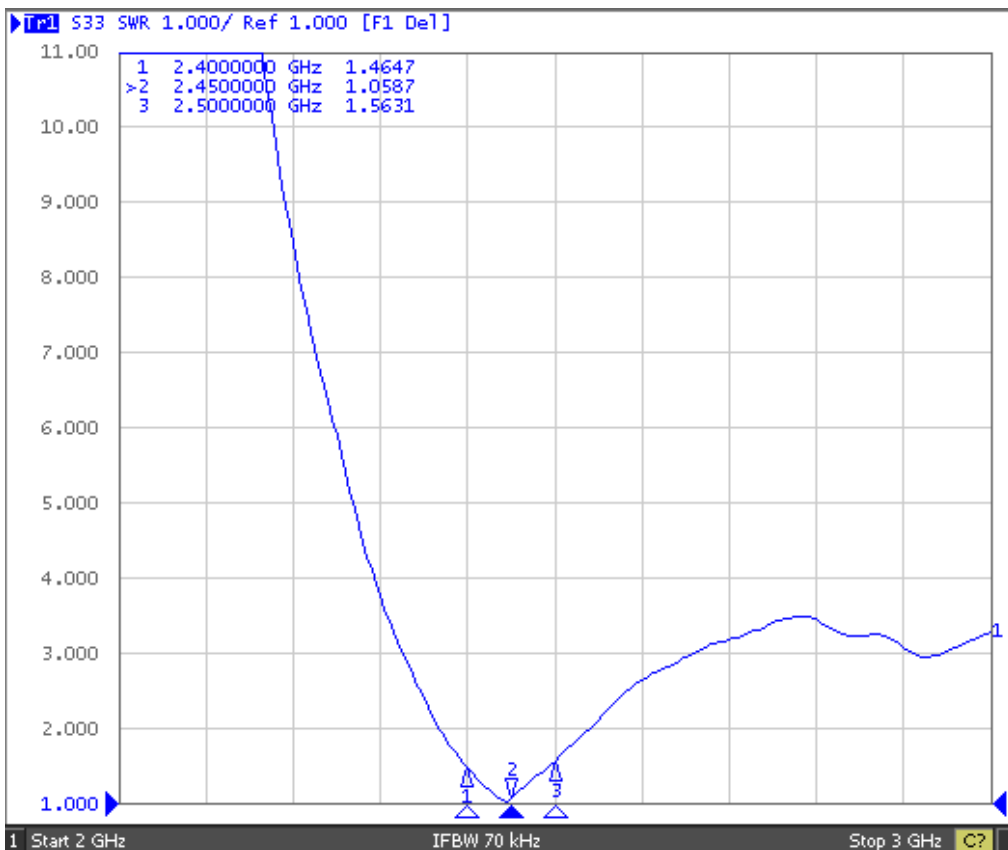

**SOLDER LAND PATTERN DESIGN**

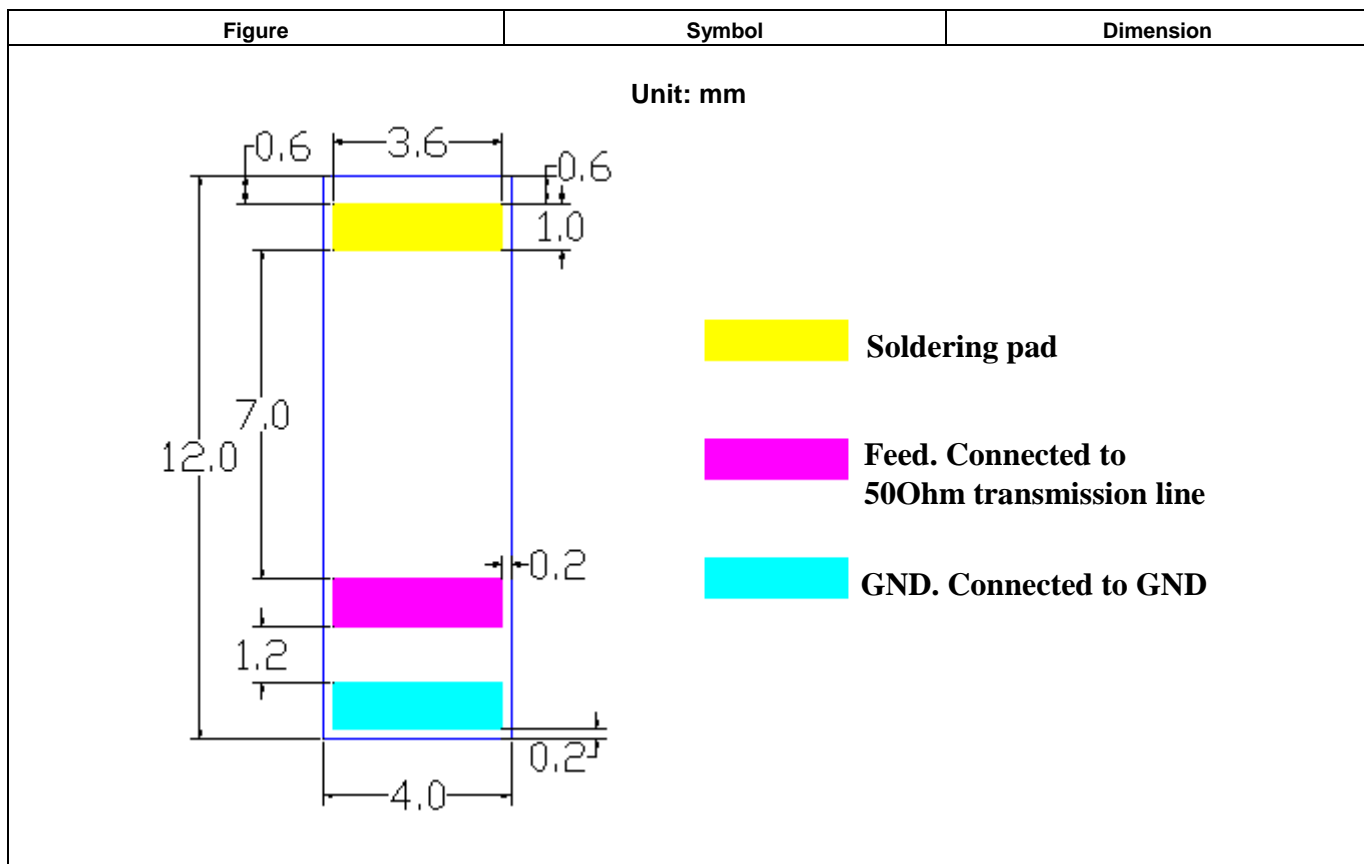

**RADIATION PATTERN**

Radiation Pattern and Gain were dependent on measurement board design. The specification of RGFR1204021A1T antenna was measured based on the test board size and the antenna installation position as shown in the below:

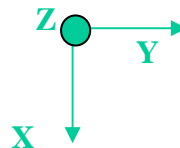
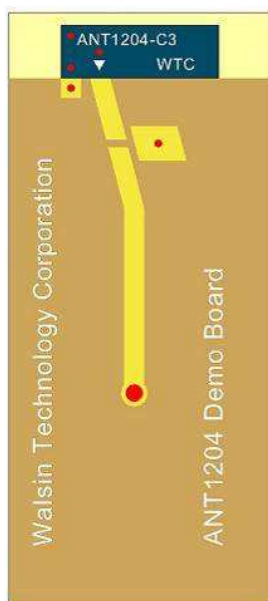

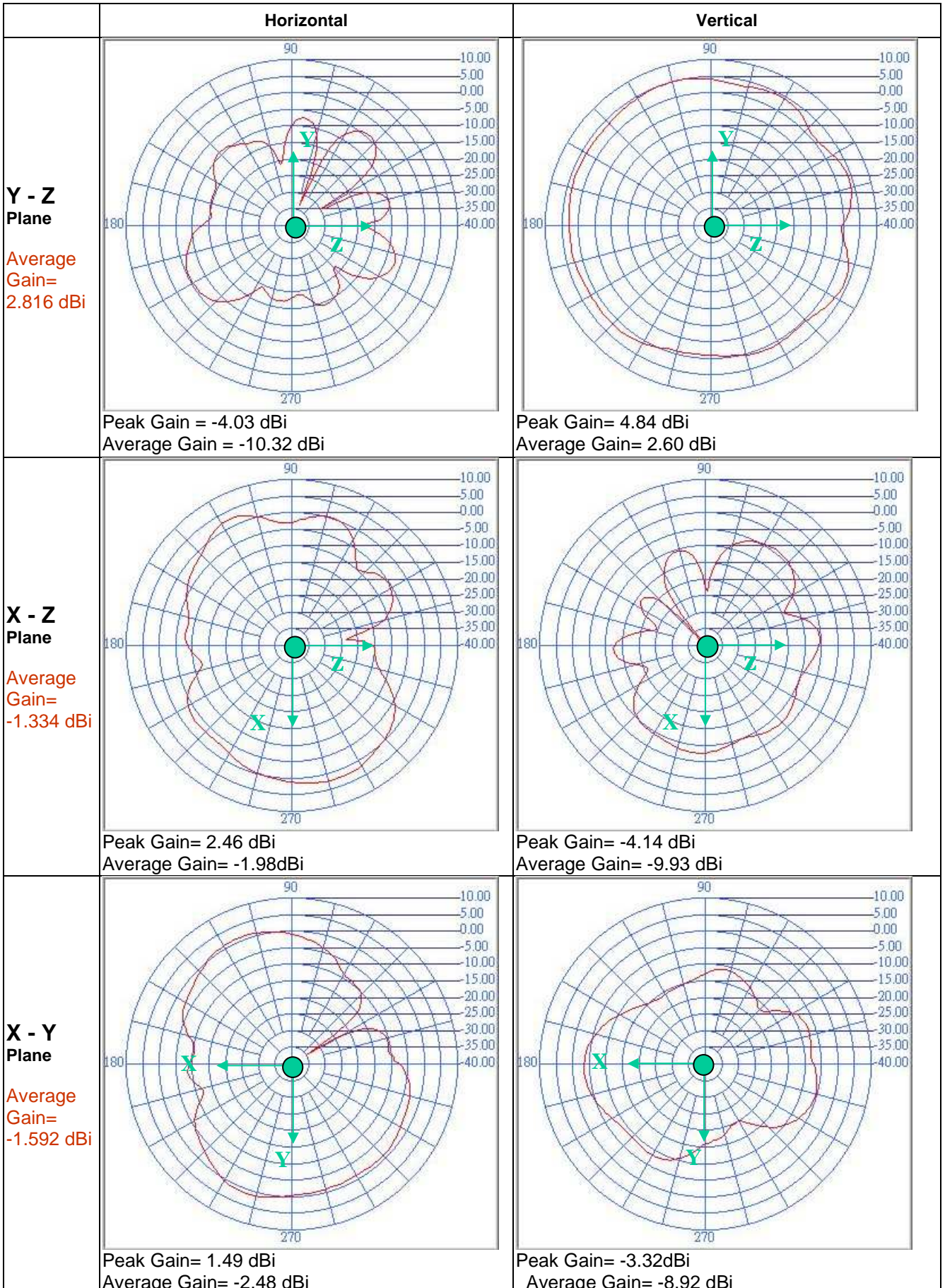

## RELIABILITY TEST

Test item	Test condition / Test method	Specification
Solderability JIS C 0050-4.6 JESD22-B102D	*Solder bath temperature : $235 \pm 5^{\circ}\text{C}$ *Immersion time : $2 \pm 0.5$ sec *Solder : Sn3Ag0.5Cu for lead-free	At least 95% of a surface of each terminal electrode must be covered by fresh solder.
Leaching (Resistance to dissolution of metallization) IEC 60068-2-58	*Solder bath temperature : $260 \pm 5^{\circ}\text{C}$ *Leaching immersion time : $30 \pm 0.5$ sec *Solder : SN63A	Loss of metallization on the edges of each electrode shall not exceed 25%.
Resistance to soldering heat JIS C 0050-5.4	*Preheating temperature : $120\sim 150^{\circ}\text{C}$ , 1 minute. *Solder temperature : $270\pm 5^{\circ}\text{C}$ *Immersion time : $10\pm 1$ sec *Solder : Sn3Ag0.5Cu for lead-free Measurement to be made after keeping at room temperature for $24\pm 2$ hrs	No mechanical damage. Samples shall satisfy electrical specification after test. Loss of metallization on the edges of each electrode shall not exceed 25%.
Drop Test JIS C 0044	*Height : 75 cm *Test Surface : Rigid surface of concrete or steel. *Times : 6 surfaces for each units ; 2 times for each side.	No mechanical damage. Samples shall satisfy electrical specification after test.
Adhesive Strength of Termination JIS C 0051- 7.4.3	*Pressurizing force : $5\text{N}(\leq 0603)$ ; $10\text{N}( >0603)$ *Test time : $10\pm 1$ sec	No remarkable damage or removal of the termination.
Bending test JIS C 0051- 7.4.1	The middle part of substrate shall be pressurized by means of the pressurizing rod at a rate of about 1 mm/s per second until the deflection becomes 1mm/s and then pressure shall be maintained for $5\pm 1$ sec. Measurement to be made after keeping at room temperature for $24\pm 2$ hours	No mechanical damage. Samples shall satisfy electrical specification after test.

**Preliminary Specification**

Temperature cycle JIS C 0025	<ol style="list-style-type: none"> <li>1. 30±3 minutes at -40°C±3°C,</li> <li>2. 10~15 minutes at room temperature,</li> <li>3. 30±3 minutes at +85°C±3°C,</li> <li>4. 10~15 minutes at room temperature,</li> </ol> Total 100 continuous cycles  Measurement to be made after keeping at room temperature for 24±2 hrs	No mechanical damage.  Samples shall satisfy electrical specification after test.
Vibration JIS C 0040	*Frequency : 10Hz~55Hz~10Hz(1min) *Total amplitude : 1.5mm *Test times : 6hrs.(Two hrs each in three mutually perpendicular directions)	No mechanical damage.  Samples shall satisfy electrical specification after test.
High temperature JIS C 0021	*Temperature : 85°C±2°C *Test duration : 1000+24/-0 hours  Measurement to be made after keeping at room temperature for 24±2 hrs	No mechanical damage.  Samples shall satisfy electrical specification after test.
Humidity (steady conditions) JIS C 0022	*Humidity : 90% to 95% R.H. *Temperature : 40±2°C *Time : 1000+24/-0 hrs.  Measurement to be made after keeping at room temperature for 24±2 hrs  ※ 500hrs measuring the first data then 1000hrs data	No mechanical damage.  Samples shall satisfy electrical specification after test.
Low temperature JIS C 0020	*Temperature : -40°C±2°C *Test duration : 1000+24/-0 hours  Measurement to be made after keeping at room temperature for 24±2 hrs	No mechanical damage.  Samples shall satisfy electrical specification after test.



**ORDERING CODE**

<b>RG</b> Walsin RG: RF /Pb free device	<b>FRA</b> Product code FRA : Antenna	<b>120402</b> Dimension code Per 2 digits of Length, Width, Thickness : e.g. : 120402= Length 12.0, Width 4.0, Thickness 2.0	<b>1</b> Unit of dimension 0 : 0.1 mm 1 : 1.0 mm	<b>A</b> Application A : 2.4GHZ ISM Band	<b>1</b> Specification Design Code	<b>T</b> Packing T : Reeled
---	---	--	--	---	--	-----------------------------------

Minimum Ordering Quantity: 1000 pcs per reel.

**PACKAGING**

Plastic Tape specifications (unit :mm)

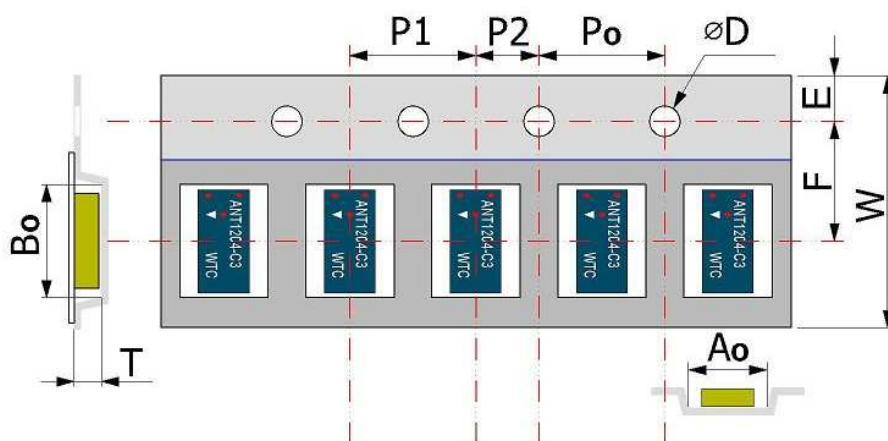

Index	Ao	Bo	ΦD	T	W
Dimension (mm)	4.3 ± 0.1	13.2 ± 0.1	2.5 ± 0.1	1.5 ± 0.1	24 ± 0.3
Index	E	F	Po	P1	P2
Dimension (mm)	1.75 ± 0.1	11.5 ± 0.1	4.0 ± 0.1	8 ± 0.1	2.0 ± 0.1

**Reel dimensions**

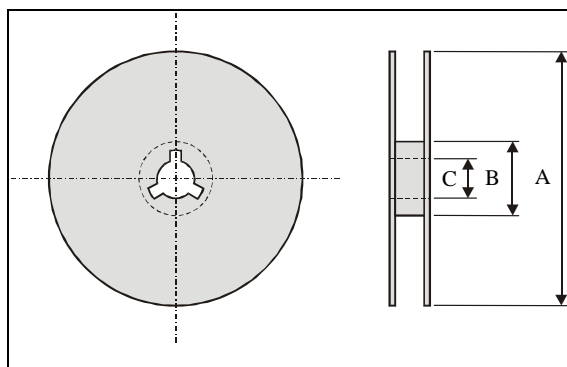

Index	A	B	C
Dimension (mm)	Φ330 ± 5.0	Φ100 ± 2.0	Φ13.0 ± 0.5

Typing Quantity: 1000 pieces per 13"-32mm reel

**CAUTION OF HANDLING****Limitation of Applications**

Please contact us before using our products for the applications listed below which require especially high reliability for the prevention of defects, which might directly cause damage to the third party's life, body or property.

- (1) Aircraft equipment
- (2) Aerospace equipment
- (3) Undersea equipment
- (4) Medical equipment
- (5) Disaster prevention / crime prevention equipment
- (6) Traffic signal equipment
- (7) Transportation equipment (vehicles, trains, ships, etc.)
- (8) Applications of similar complexity and /or reliability requirements to the applications listed in the above.

**Storage condition**

- (1) Products should be used in 6 months from the day of WALSIN outgoing inspection, which can be confirmed.
- (2) Storage environment condition.
  - Products should be storage in the warehouse on the following conditions.
  - Temperature : -10 to +40°C
  - Humidity : 30 to 70% relative humidity
  - Don't keep products in corrosive gases such as sulfur. Chlorine gas or acid or it may cause oxidization of electrode, resulting in poor solderability.
  - Products should be storage on the palette for the prevention of the influence from humidity, dust and son on.
  - Products should be storage in the warehouse without heat shock, vibration, direct sunlight and so on.

Products should be storage under the airtight packaged condition.